



**PL / PLX  
Digital DC Drive  
SERIAL COMMS  
Manual**



NOTE. These instructions do not purport to cover all details or variations in equipment, or to provide for every possible contingency to be met in connection with installation, operation, or maintenance. Should further information be desired or should particular problems arise which are not covered sufficiently for the purchaser's purposes, the matter should be referred to the local Supplier sales office. The contents of this instruction manual shall not become part of or modify any prior or existing agreement, commitment, or relationship. The sales contract contains the entire obligation of Sprint Electric Ltd. The warranty contained in the contract between the parties is the sole warranty of Sprint Electric Ltd. Any statements contained herein do not create new warranties or modify the existing warranty.

**IMPORTANT MESSAGE.** This is a version 5.14 Serial communications manual. Units that are installed with version 5.14 upward software have all the functions described. For units that are installed with older version software, please refer to the record of modifications at the back of the manual to confirm functionality differences. This manual describes the ANSI protocol serial comms link available in the PL/X, and the FIELDBUS functions. It should be used with the main PL / PLX Digital DC Drive product manual.

1	Glossary of terms.....	5
2	Introduction .....	7
2.1	How to use a USB port .....	7
2.2	SCADA package with built in multi-drop protocol drivers.....	7
2.3	PL PILOT with multi-drop capability.....	7
3	SERIAL LINKS / RS232 PORT 1 .....	8
3.1	RS232 PORT1 / PORT1 COMMS LINK.....	8
3.1.1.1	PORT1 COMMS LINK / Port 1 group number identity PIN 193 .....	9
3.1.1.2	PORT1 COMMS LINK / Port 1 unit number identity PIN 194.....	9
3.1.1.3	PORT1 COMMS LINK / Port 1 error code PIN 195.....	9
3.1.1.4	PORT1 COMMS LINK / Port 1 digital OP3 RTS mode PIN 196 .....	10
3.1.2	Electrical connections. This example is for 4 PL/Xs on one link. ....	11
3.1.2.1	Item 1. 5 convertors. (1 for computer and 1 per drive) B&B Model 485O19TB0798 .....	11
3.1.2.2	Item 2. 4 Interconnection cables (PL/X FCC serial port to a D type convertor plug).....	11
3.1.2.3	Item 3. Stand alone 12 volt PSU capable of supplying at least 10mA per convertor.....	11
3.1.2.4	Item 4. Cable with three twisted pairs.....	11
3.1.2.5	Wiring diagram. 4 wire Full Duplex with secondary power supply.....	11
3.2	PORT 1 COMMS LINK / General description .....	12
3.3	ASCII Communications / Multi Drop Supervisory Link .....	12
3.4	Description of ASCII .....	13
3.5	Control characters .....	13
3.6	Data types.....	14
3.7	Data Format .....	14
3.8	Character Format .....	14
3.9	Status Information.....	14
3.10	Data Transfer Sequence .....	15
3.11	Sequence to send information to the PL/X from the computer.....	15
3.11.1	Responses by PL/X .....	15
3.11.2	Termination of selection of a PL/X.....	16
3.12	Sequence to read information from the PL/X by computer .....	16
3.12.1	Enquiry from host (symbol definition).....	16
3.12.2	Valid response of the PL/X to this message .....	17
3.12.3	Further enquiry and termination .....	17
3.12.4	No response to host computer .....	18
3.12.5	Baud rate.....	18
4	PL PILOT and SCADA (System Control And Data Acquisition) package .....	18
5	FIELDBUS introduction.....	20
5.1	CONFIGURATION / FIELDBUS CONFIG .....	20
5.1.1	FIELDBUS CONFIG / JUMPER 1 - 8.....	21
5.1.2	FIELDBUS CONFIG / BIT-PACKED GET FROM.....	21
5.1.3	Key features of FIELDBUS CONFIG JUMPERS 1 - 8 and BIT-PACKED GETFROM windows .....	21

5.1.4	FIELDDBUS CONFIG / JUMPER 9 - 16.....	22
5.1.5	FIELDDBUS CONFIG / BIT PACKED GOTO.....	22
5.1.6	Key features of FIELDDBUS JUMPERS 9 - 16 and the BIT-PACKED GOTO windows.....	22
5.1.7	Automatic optimisation of network traffic.....	23
5.1.8	FIELDDBUS CONFIG JUMPER connections .....	23
5.1.9	FIELDDBUS CONFIG / Fieldbus data control .....	23
<b>5.2</b>	<b>CONFIGURATION / ENABLE GOTO, GETFROM .....</b>	<b>24</b>
<b>5.3</b>	<b>CONFIGURATION / CONFLICT HELP MENU .....</b>	<b>24</b>
5.3.1	CONFLICT HELP MENU / Number of conflicts .....	24
5.3.2	CONFLICT HELP MENU / Multiple GOTO conflict PIN identifier .....	24
<b>5.4</b>	<b>Input / output mapping for configured parameters.....</b>	<b>25</b>
5.4.1	FIELDDBUS CONFIG JUMPERS 1 - 8 and BIT-PACKED GETFROM.....	25
5.4.2	FIELDDBUS CONFIG JUMPERS 9 - 16 and BIT-PACKED GOTO.....	25
<b>6</b>	<b>PL/X FIELDDBUS hardware requirements .....</b>	<b>25</b>
<b>7</b>	<b>PROFIBUS card settings .....</b>	<b>26</b>
<b>7.1</b>	<b>Function of the LED's .....</b>	<b>27</b>
7.1.1	Indications on Watchdog LED .....	27
<b>7.2</b>	<b>Node address .....</b>	<b>27</b>
<b>7.3</b>	<b>Termination.....</b>	<b>28</b>
<b>8</b>	<b>Record of Comms manual modifications .....</b>	<b>29</b>
<b>9</b>	<b>Record of Comms bug fixes.....</b>	<b>29</b>
<b>10</b>	<b>Changes to product since manual publication .....</b>	<b>29</b>
<b>11</b>	<b>Mnemonic table.....</b>	<b>30</b>

## 1 Glossary of terms.

**ASCII** (American Standard Code for Information Interchange): A 7 or 8 bit code established by the American National Standards Institute (ANSI) to achieve compatibility between data services. Compatible with the International Standards Organisation (ISO) 7/8 bit code.

**Asynchronous Communication:** Transmission in which each data character is individually synchronised

**Baud (Bd):** A unit of signalling speed equal to the number of signal events per second. Not necessarily the same as bits per second. The rate at which the data is sent, which must be matched for all parties.

**Binary Coded Decimal:** A system of binary numbering where each decimal digit 0 to 9 is represented by a combination of four bits

**Bit:** Contraction of binary digit. The smallest unit of information. A bit represents the choice between a one or zero value (mark or space in communications technology)

**Bit Rate:** The speed at which bits are transmitted, usually expressed in bits per second

**Broadcast:** A system where one transmitting device sends the same data to multiple receivers

**Buffer:** A storage device used to compensate for a difference in rate of data flow, or time of occurrence of events, when transferring data between devices. Also a device without storage that isolates two circuits

**Byte:** A binary element string operated on as a unit and usually shorter than a computer word. Normally 8 bit

**Character:** A letter, figure, number, punctuation or other symbol contained in a message or used in a control function  
**Character Set:** The set of characters that can be coded and/or printed by a particular machine

**Code:** A set of unambiguous rules specifying the way in which characters may be represented.

**Communication Turnaround-** Changeover from transmit to receive or vice versa in a half duplex system

**Complementary pair:** The signal and its complement. Usually transmitted on a twisted pair of wires. This increases noise immunity and the transmission distance. (RS422 and RS485 utilise complementary pairs)

**CTS** (Clear To Send): A signal, defined in the RS-232 standard, to indicate that **DCE** is ready to transmit

**Data Communication Equipment (DCE):** The equipment that provides the functions required to establish, maintain and terminate a connection, and provides the signal conversion required for communication between data terminal equipment and the telephone data line

**Data Terminal Equipment (DTE):** A computer or other terminal that provides data in the form of digital signals

**DCD (Data Carrier Detect):** A control signal generated by **DCE** to indicate that it is receiving a valid signal

**Digital Signal:** A discrete or discontinuous signal whose various states are identified with discrete levels

**DSR (Data Set Ready):** A control signal, defined in the RS-232 standard, to indicate the status of **DCE**

**DTR (Data Terminal Ready):** A control signal defined, in the RS-232 standard, to indicate the status of **DTE**

**Enable/Disable:** To enable a circuit. Prepares it to perform the intended function

**Full Duplex:** Refers to a communications system or equipment capable of simultaneous two-way comms

**Ground:** Common electrical level to which devices are referred

**Half Duplex:** Refers to a communications system or equipment capable Of Communications in both directions, but only one at a time

**Handshaking:** Exchange of predetermined codes and signals between two data devices to establish and control a connection

**Hexadecimal:** Refers to the practice of counting to the base of 16 in rather than the base of 10. The sixteen numbers used being 0 to 9, A to F. Thus an 8 bit byte is represented by two characters in the range 00 to FF, while a 16 bit word is represented by four characters in the range 0000 to FFFF.

**Interface:** A shared boundary defined by common physical and signal characteristics and meanings of interchanged signals

**Isolation Voltage:** The voltage which an isolated circuit can withstand. Isolation voltage is specified between two or more points

**Loop-back Test:** A test of a communications link performed by connecting the equipment output of one direction to the equipment input of the other direction and testing the quality of the received signal.

**Mark:** One of two possible states of a binary information element. See Bit, Space.

**Modem (MOdulator/DEModulator):** A type of **DCE** that converts digital data to an analog signal for transmission on telephone circuits.. A modem at the receiving end converts the analog signal to digital form

**Multi-drop:** A system of serial communication that allows multiple transmitter/receiver combinations to be connected to a single line

**Optical Isolation:** Two networks coupled only through an opto-electronic sender and receiver with no electrical conductivity between the two networks

**Parity Bit:** One of the bits that may be incorporated in a character. Used as a simple form of error detection

**Port:** An interface on a computer configured as data terminal equipment and capable of communication with another device

**Protocol:** The rules for communication between like processes, giving a means to control the orderly communication of information

**RI (Ring Indicator):**Control signal defined in the RS-232 standard, shows that DCE is receiving a ringing signal

**RS (Recommended Standard) 232/422/485:** Designations of various recommendations formulated to standardise the hardware interface between connected computers, terminals, modems, instruments etc.

**RTS (Ready To Send):** A signal defined in the RS-232 standard, generated by DTE to instruct DCE to transmit

**Serial Transmission:** A method of information transfer in which the bits comprising a character are sent in sequence one at a time

**Space:** One of two possible states of a binary information element. See Bit, Mark

**Start Bit:** The first bit transmitted in the asynchronous transmission of a character to synchronise the receiver

**Stop Bit:** The last bit in the asynchronous transmission of a character to return to the at-rest condition

**Tri-state:** A binary output signal is either a 0 or 1. There is a third requirement that it becomes disconnected from a line, in order to allow another device sharing the line to become connected. This gives a total of 3 states, the disconnected mode being the tri-state. Tri-state is achieved by designing the output stage of an electronic binary device with the ability to turn completely off and present a high impedance to the line.

## 2 Introduction

The PL/X is provided with an RS232 serial port as standard. The port may be used in a number of different modes which are selected using the RS232 PORT 1 / 188)PORT1 FUNCTION.

The modes available are as follows.

- |  |                                 |
|--|---------------------------------|
| 1) PARAMETER EXCHANGE  | (SEE MAIN MANUAL)               |
| Computer to PL/X in ASCII  | For transferring configurations |
| PL/X to PL/X in ASCII  | For transferring configurations |
| Menu list from PL/X to printer or computer   | To list configurations.         |
|  |                                 |
| 2) REFERENCE EXCHANGE  | (SEE MAIN MANUAL)               |
| For high-speed exchange of parameters between 2 or more units in digital format during running |                                 |
|  |                                 |
| 3) ASCII COMMS   |                                 |
| For controlling one or more units from a host computer using a serial link.                    |                                 |
| For configuring one or more units using PL PILOT, a PC based configuration tool.               |                                 |

This manual is devoted to the 3<sup>rd</sup> mode of operation using ASCII COMMS.

### 2.1 How to use a USB port

The PL/X uses an RS232 port to transmit serial data. Some computers may not be fitted with an RS232 COM port. Instead they will probably possess a USB port. In this case it is necessary to fit a USB - RS232 convertor to the computer (E.g. Belkin F5U120uPC). These are supplied with the required driver utilities. After installation of the convertor, right click on the 'My Computer' icon and select Properties / Device Manager / Ports, to find the port allocations. (COM1, COM2, COM3 etc.). Then you must use the nominated USB port allocation when setting up comms utilities. Eg. HyperTerminal or PL PILOT (Options in top task bar). **Note. When using USB to RS232 converters always boot up the PC with the converter plugged into the PC so that it gets properly initialised.**

### 2.2 SCADA package with built in multi-drop protocol drivers

A SCADA package called SPECVIEW is available that allows Instrument views, System graphics, Trend charts, Data logging, System recipe downloading, Historical screen replay and many other features.

This package runs on a standard PC and can support any number of units up to 100 on a single link. By using this SCADA package, all the effort required to translate and implement the ASCII COMMS protocol is already built in to the package. This gives access to all parameters and connections on all the connected instruments as soon as the link is hooked up. See 4 PL PILOT and SCADA (System Control And Data Acquisition) package.

### 2.3 PL PILOT with multi-drop capability

There is also a configuration tool called PL PILOT available that runs on a standard PC. This may be used to set any parameter value, make any legal internal connection, and monitor all the available parameters.

PL PILOT provides the user with block diagrams where each parameter may be quickly accessed and altered. The system allows recipes of drive configurations to be stored and/or down loaded as desired.

PL PILOT is also able to support up to 10 drives on one link. It can access all parameters, connections and diagnostics for each drive. It is able to display these from any drive or combinations of drives and send recipes to any drive on the link.

This powerful tool is available free of charge.

The operating instructions for PL PILOT are contained within the tool itself. Click on the Help BUTTON. See 4 PL PILOT and SCADA (System Control And Data Acquisition) package.

### 3 SERIAL LINKS / RS232 PORT 1

PINs used 187 to 195.

The RS232 PORT1 is located just above the middle set of control terminals. It is a female 4 way FCC-68 type socket.

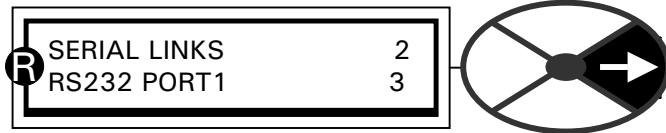

There is an option to select ASCII COMMS in 188)PORT1 FUNCTION to implement a full duplex ANSI communications protocol for use with a host computer or for interface with PL PILOT, a PC based configuration tool.

After selecting ASCII COMMS, go to the sub-menu called PORT 1 COMMS LINK in order to set up the link operation.

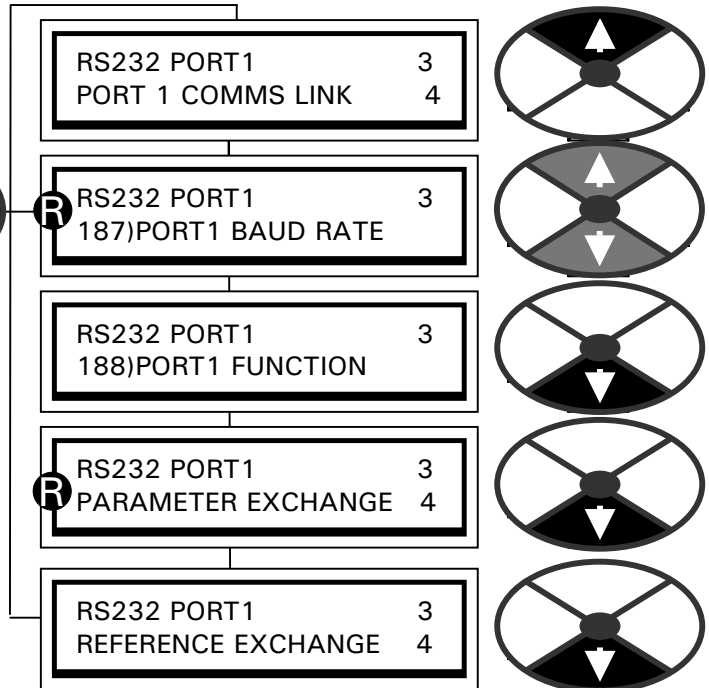

#### 3.1 RS232 PORT1 / PORT1 COMMS LINK

Pins used 193 to 196

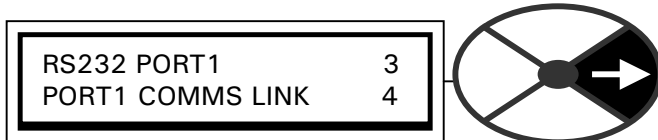

This menu has 3 functions.

1) It is used to set the identifying address of the PL/X.

2) It allows access to the error code display.

3) Enables the digital output DOP3 on terminal 24 to be utilised as an RTS output.

The RTS (Ready to send) signal is used to control certain types of external serial link driver units.

**WARNING.** Comms functions are suspended whilst the unit is in **CONFIGURATION** mode. See section 13 of the main manual.

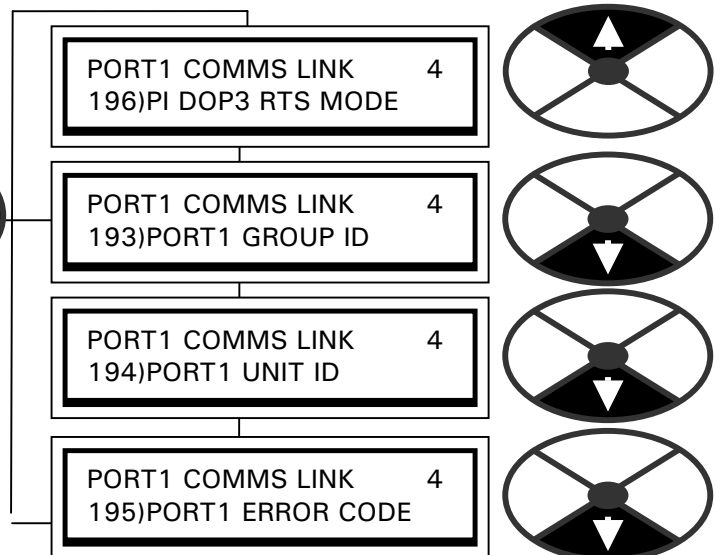



3.1.1.1 PORT1 COMMS LINK / Port 1 group number identity PIN 193

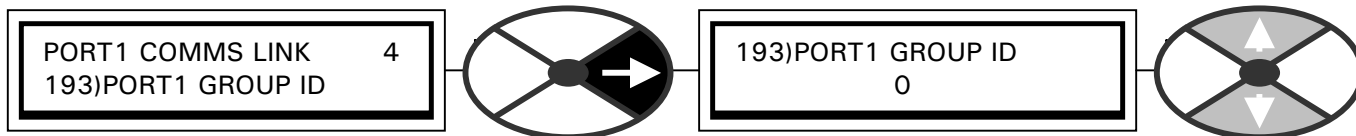

Defines group number (GID) for up to 8 groups of 16 units.

PARAMETER	RANGE	DEFAULT	PIN
PORT1 GROUP ID	0 to 7	0	193

See 3.12.1 Enquiry from host (symbol definition)

3.1.1.2 PORT1 COMMS LINK / Port 1 unit number identity PIN 194

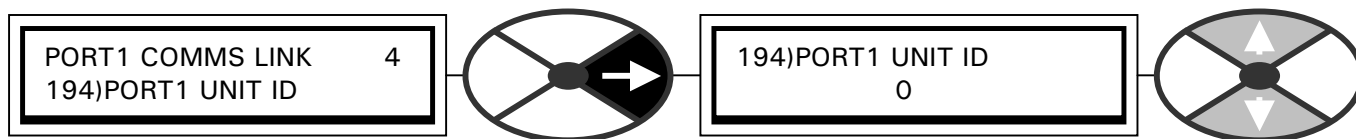

Defines unit number (UID) for up to 16 units in each group.

PARAMETER	RANGE	DEFAULT	PIN
PORT1 UNIT ID	0 to 15	0	194

See 3.12.1 Enquiry from host (symbol definition)

3.1.1.3 PORT1 COMMS LINK / Port 1 error code PIN 195

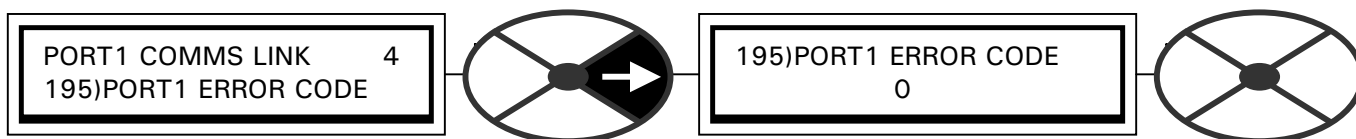

Displays an error code to assist in de-bugging the comms link.

PARAMETER	RANGE	DEFAULT	PIN
PORT1 ERROR CODE	See table below	0	195

Mnemonic AA	Error Report	Read/write	Returns one of the following to indicate the status of serial link transmissions
			0001 No transmission errors 0002 Unrecognised mnemonic 0003 Character fail during block check 0004 Received data parity error 0005 Overrun or framing error 0006 Writing to a read-only mnemonic 0007 Message format Invalid 0008 Out of range value in selection message  Writing any value to mnemonic AA resets it to 0001
Mnemonic I I	PL/X Identifier	Read only	Returns the instrument identity, the default value is BABE.

## 3.1.1.4 PORT1 COMMS LINK / Port 1 digital OP3 RTS mode PIN 196

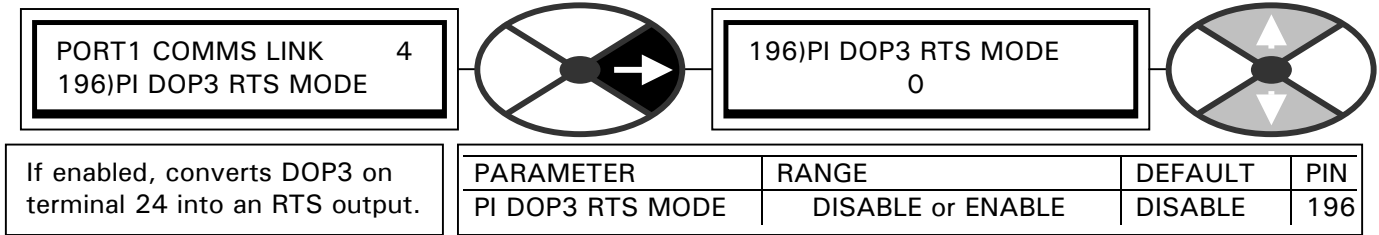

When using a multi-drop system, the RS232 port on the PL/X must be buffered by an RS422 or RS485 convertor unit external to the PL/X. There are many types of convertor available. The convertor should not be allowed to send data onto the serial link unless it has been requested to do so and should remain tri-stated until it is required to talk.

Some convertors are designed to automatically control their own tri-state mode. However other types require an external control signal to be provided. This signal is referred to as the RTS (Ready to send) signal.

This window is used to change the mode of operation of the digital output DOP3 on terminal 24.

If RS232 PORT 1 / 188)PORT1 FUNCTION has been placed in ASCII COMMS mode, and 196)P1 DOP3 RTS MODE has been ENABLED, then DOP3 functions as an RTS output.

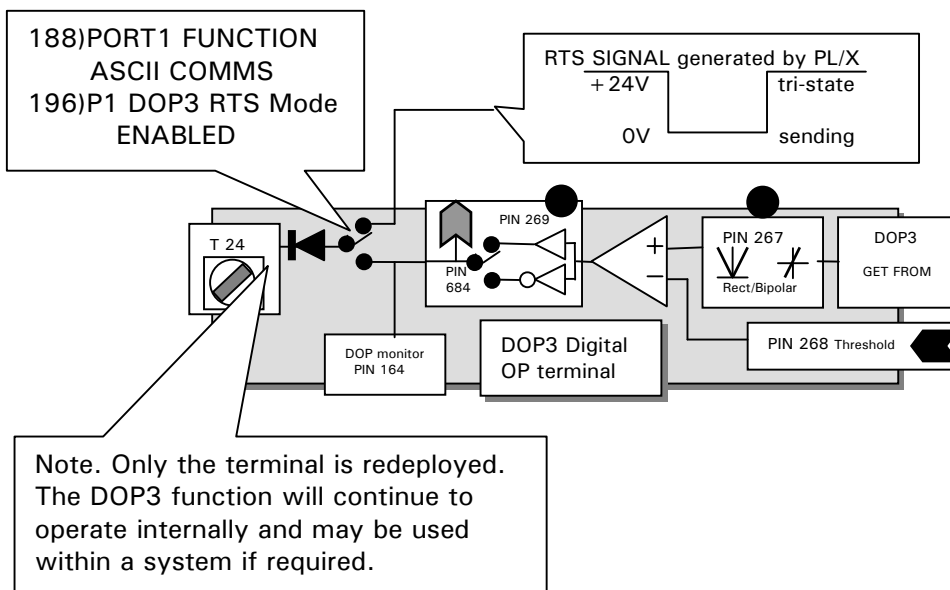

The RTS signal is 24V logic

High requests a tri-state output from the convertor. Low (0V) requests an active state from the convertor. A pull down resistor may be added to terminal 24 to ensure a hard 0 if required. Refer to convertor supplier for details of the RTS logic levels required by the convertor.

When the PL/X has been requested to transmit by the host and is ready to do so, the RTS signal will go low. It will remain low until the host sends EOT (End of transmission) to the PL/X. **Hence in order to use this system, a 4 wire RS422/485 link must be implemented to enable the host to talk to the PL/X while the convertor is still active. (1 complementary pair is used for sending, a separate complementary pair for receiving).**

Note. To ensure that the PL/X powers up with the RTS signal high, it is necessary to perform a PARAMETER SAVE of the 196)P1 DOP3 RTS MODE / ENABLED.

Note. If 196)P1 DOP3 RTS MODE is set to DISABLED at any time then DOP3 immediately functions as normal.

3.1.2 Electrical connections. This example is for 4 PL/Xs on one link.

This is a description of the connections required to implement a 4 wire full duplex system using B&B Electronics RS232 to 485 convertors. (These convertors have an automatic tri-state capability).

3.1.2.1 Item 1. 5 convertors. (1 for computer and 1 per drive) B&B Model 485O19TB0798

The 4 drive convertors must be modified to accept a 24V power supply from the PL/X serial port. This is very simple. Remove the plastic cover from the convertor. Solder a 2K2 resistor with 0.6 in lead diameter between pin 8 of the D type connector and the via on the back of the printed circuit board as shown. Take care to avoid shorts etc. This drops the PL/X 24V down to 5V within the convertor. Replace the plastic cover.

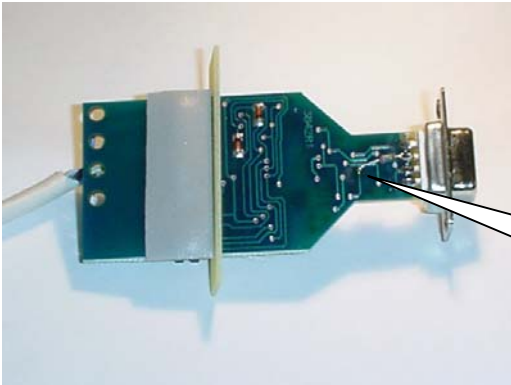

Connect 2k2 resistor from pin 8 on the D socket to this via. (Zoom this picture in WORD to 500% for a good look).

3.1.2.2 Item 2. 4 Interconnection cables (PL/X FCC serial port to a D type convertor plug)

These cables must be kept as short as possible. The convertor should be mounted locally to its host PL/X. PL/X socket is type FCC68 4 way.

pin	function	Connect to Male D pin plug
W	0V	D5
X	+ 24V	D8. Connects to added 2K2
Y	transmit	D3
Z	receive	D2

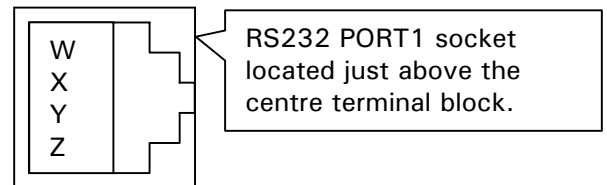

3.1.2.3 Item 3. Stand alone 12 volt PSU capable of supplying at least 10mA per convertor.

This is used to power up the serial link which is optically isolated from all instruments and the host PC.

3.1.2.4 Item 4. Cable with three twisted pairs.

Recommended type is 24 AWG twisted pairs telephone cable with a shunt capacitance of 16 picofarad per foot (30cm). If you are using termination resistors on the RS485 complementary pairs they should be located at opposite ends of the system.

3.1.2.5 Wiring diagram. 4 wire Full Duplex with secondary power supply.

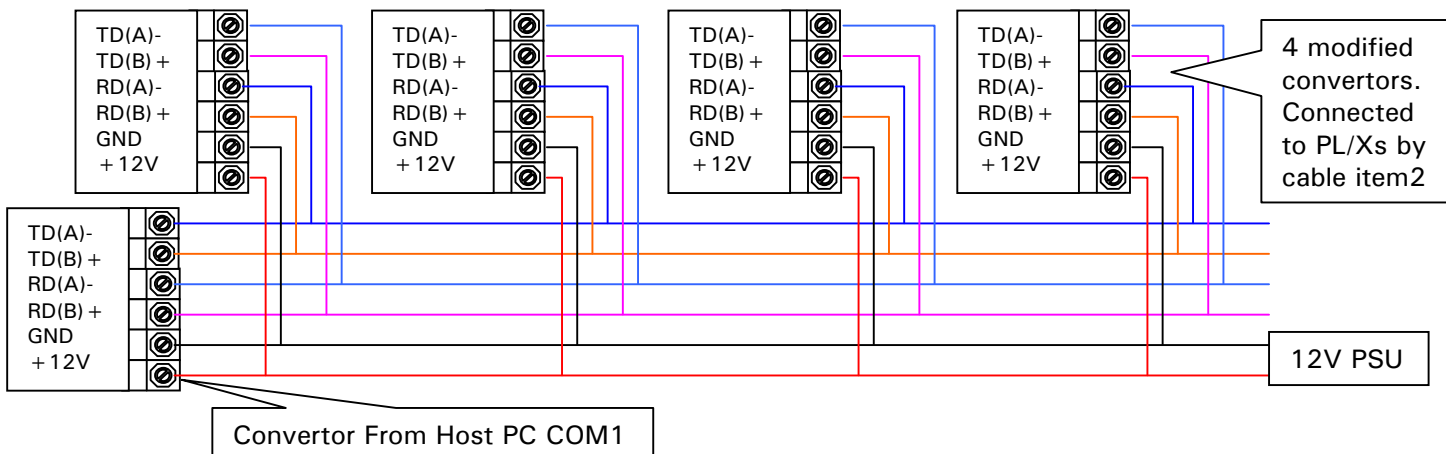

### 3.2 PORT 1 COMMS LINK / General description

Supervision and monitoring of Sprint Electric PL/X Series drives has been made possible by the provision of a supervisory communications interface. This option provides a serial data port that can be set up on each drive. When using RS422 or RS485 links they can be bussed together to allow an intelligent device to monitor or update the parameters of a network of drives.

Using this link a supervisory control system can be implemented where each drive is in continuous local control and the central computer has only to perform periodic reference updating, control sequencing and data collection.

The main advantages of this type of control system are: -

- 1) Multi-wire analogue transmission from a central programmable controller is replaced by a bussed digital system using serial data transmission over twisted pairs.
- 2) Digital transmission is fundamentally less noise-prone than analogue methods, and the accuracy of the transmitted data is unaffected by the transmission medium. The use of intelligent devices at either end of the data link allows error checking to be used. This virtually eliminates the effects of electrical noise on data integrity. It is therefore possible to issue references to drives with much higher accuracy using this method.
- 3) The communication standard used allows up to 128 devices to be addressed from a single link, which can be driven from a computer serial port. Additional drives can be readily accommodated through additional computer ports. Most computers are equipped with RS232 serial ports, which can be easily converted to accommodate the RS422 or RS485 standard by using a proprietary bus convertor.

The specific form of communication implemented corresponds with the following full American National Standard definition: -

ANSI Standard: x3.28 Revision: 1976 Establishment and Termination Control Procedures Sub-category 2.5: Two-way Alternate, Non-switched Multipoint with Centralised Operation and Fast Select.

Message Transfer Control Procedure Sub-category B 1:

Message Associated Blocking, with Longitudinal Checking and Single Acknowledgment.

This is known by the abbreviation: ANSI - x3.28 - 2.5 - B 1.

### 3.3 ASCII Communications / Multi Drop Supervisory Link

Transmission Standard	RS232 / RS422 / RS485		
Protocol	ANSI-X3.28-2.5-B 1		
Data Rates	300, 600, 1200, 2400, 4800, 9600 or 19200 baud		
Character Format	(300 to 19200 baud) 1 start, 7 ASCII bits, 1 parity and 1 stop bit (10 BIT)		
Parity	None		

Digital Communications	RS 232 (1 drive only)	RS 422	RS 485
Electrical Connections	2 wire transmit and receive plus 0V	4 wire differential	4 wire differential
Maximum cable length	30 ft / 10 metres	3000 ft / 1000 metres	3000 ft / 1000 metres

### 3.4 Description of ASCII

1) (American Standard Code for Information Interchange)

ASCII is a binary code which represents letters, digits, and control signals (collectively called characters). The code originated by the American National Standards Institute (ANSI) has become a worldwide standard for information interchange. The code uses a seven bit binary word to represent all the letters, digits, punctuation marks and control signals, and a complete list of code mnemonics for the PL/X parameter set is given at the end of the manual. See 11 Mnemonic table.

ASCII codes	ASCII hex
STX Start of Text	02
ETX End of Text	03
EOX End of Transmission	04
ENQ Enquiry	05
ACK Positive acknowledge	06
NAK Negative acknowledge	15
Space	20
- Minus Sign	2D
* Decimal Point	2E
> Greater than	3E
0	30
1	31
2	32
3	33
4	34
5	35
6	36
7	37
8	38
9	39

### 3.5 Control characters

Control Characters are ASCII binary codes, which define actions rather than information. Six ASCII codes are used: -

#### ASCII-HEX

- 02 (STX) This is the start of text character.
- 03 (ETX) This is the end of text character. It is followed by another character containing the checksum.
- 04 (EOT) Indicates the end of transmission. It therefore clears the line and is sent by the host at the start of a new message.
- 05 (ENQ) This is the enquiry character. It is sent by the host as the last character of any type of polling message.
- 06 (ACK) This is the positive acknowledgment character.
- 15 (NAK) This is the negative acknowledgment character.

#### PL/X Address

The PL/X has an address, the first digit being the group number (GID) in the range 0 to 7, the second a unit number (UID) in the range 0 to F. There are therefore 128 different addresses from 00 to 7F.

### 3.6 Data types

Data can be considered to consist of two types: -

- 1) Numerical Data: - Where the parameter refers to number which is a level, reference, gain or result with the PL/X being either positive or negative.
- 2) Boolean Data: - Where a Boolean (logic) parameter such as a switch can be monitored enabled, or disabled from the serial link.
- 3) Status Information: - Where the parameter refers to a binary word each bit within the word being a significant switch within the program structure.

Examples of status information are for 182)STORED TRIP MONITOR: (DZ ASCII mnemonic)

Bit 2 represents the over volts alarm bit 8 stall trip alarm bit 14 short cct IO

### 3.7 Data Format

The PL/X uses an ASCII, free format, mode of operation for data transfer to make it easy to implement with languages such as BASIC, PASCAL, FORTRAN and assembler languages. This makes it possible to implement a simple supervisory system using a personal computer.

Numerical Data

(Format 21 - Free Format Numeric)

Numerical Data is transferred by transmission of a string of characters, the length of the string required to transmit the data value is determined by the value itself, no leading zeros are added to pad out the string length, and trailing zeros may be omitted.

i.e. 1 can be sent as 1.00, 1.0, 1. or 1  
 -3.4 can be sent as -3.40  
 12.34 is sent as 12.34

### 3.8 Character Format

The bit format is represented by the following-

Start LO Bit	DATA bit	DATA bit	DATA bit	DATA bit	DATA bit	DATA bit	DATA bit	Unused Parity bit	Stop HI bit
--------------------	-------------	-------------	-------------	-------------	-------------	-------------	-------------	-------------------	-------------------

### 3.9 Status Information

(Format 23 - Hexadecimal) Status Information is transmitted by first encoding the data into a hexadecimal format. The number of characters in the encoded data then determines the length of a string. The hexadecimal data is preceded by a > sign to differentiate from numerical data.

### 3.10 Data Transfer Sequence

The data transfer sequence in the ASCII mode offers the following facilities

- 1) Asking questions (known as polling)
  - a. Single parameter poll
  - b. Continuous polling of one parameter
  - c. Sequential polling down the parameter list table (fast polling)
- 2) Setting parameters (known as selection)
  - a. Single parameter update
  - b. Continuous updating of one or more individual parameters

### 3.11 Sequence to send information to the PL/X from the computer

Connection is established with a particular PL/X by sending

(EOT) (GID) (GID) (UID) (UID) followed immediately by the data transfer

(STX) (C1) (C2) (D1) (D2) (D3)..... (DN) (ETX) (BCC) (Note that the data transfer message is identical to that transmitted by a PL/X when giving a valid reply), The symbols of this message are defined as follows: -

(STX) start of text character

After transmission of the whole message,

(C1)(C2) parameter specified by ASCII mnemonic

(D1 to DN) parameter value

(ETX) end of text character

(BCC) Block Check Character (verification check digit which is again the exclusive OR of (C1) to (ETX) inclusive and must be calculated by the computer before transmission).

#### 3.11.1 Responses by PL/X

The PL/X responds to it by sending (ACK), (NAK) or by giving no reply.

1) Positive acknowledgment (ACK)

When the PL/X has received the message, it performs the following tasks: -

Checks for any parity errors in the message. If none then it...

Verifies that the (BCC) character corresponds to the data pattern received. If no error then it...

Verifies that the (C 1), (C2) command characters are a valid mnemonic that may be written to. If so then it...

Verifies that the data (D1 to DN) is valid and not out-of-range. If so then it...

Updates the selected parameter with the new value contained in the message.

Only when all these tasks have been successfully completed does the PL/X send the (ACK) response to the computer.

This signifies that the message was correctly received and implemented. Note. Data out-of-range returns NAK and is discarded.

## 2) Negative acknowledgment (NAK)

If the message fails any of the above checks, the PL/X sends the (NAK) response to the computer. This signifies that the message received by the PL/X contained an error and accordingly it has not updated the selected parameter. One possible reason is the incorrect calculation of (BCC). At this point, the selected command may be repeated by sending the data transfer string without re-establishing connection, until the computer receives the (ACK) response.

## 3) No Reply

Under certain circumstances, the computer may not receive a response from the PL/X. This could be due to any of the following reasons: -

Hardware failure.

Group Unit address identifiers not recognised.

Communications loop failure perhaps due to noise or wrong baud rate selected.

An error (e.g. parity) is found in one or more of the characters up to and including (BCC).

In these cases the computer should be programmed to time-out, i.e. wait for a response for a short time (150 msec minimum) before trying again.

### 3.11.2 Termination of selection of a PL/X

The termination procedure is used if the computer wishes to stop selecting a particular PL/X and establish connection with another. This is achieved by sending the establish connection sequence. The computer then transmits an (EOT) character to reset all PL/Xs on the data link to be responsive to the next GID UID address parameter.

## 3.12 Sequence to read information from the PL/X by computer

### 3.12.1 Enquiry from host (symbol definition)

The computer always has master status, with the PL/X always in slave status. The computer begins by transmitting a message, called the establish connection message, which is represented by the following format: -

(EOT) (GID) (GID) (UID) (UID) (C1) (C2) (ENQ)

These symbols are defined as follows: -

(EOT) This control character resets all PL/Xs on the link and causes them to examine the next four transmitted characters to see if they correspond with their group/unit address identifiers.

(GID) These characters represent the required group address identifier, and are repeated for security. See 3.1.1.1 PORT1 COMMS LINK / Port 1 group number identity PIN 193

(UID) These characters represent the required unit address identifier, repeated for security. (Together these units define the address of a particular PL/X). If, for example, GID = 1 and UID = 6, then the PL/X to be addressed is number 16. See 3.1.1.2 PORT1 COMMS LINK / Port 1 unit number identity PIN 194

(C1)(C2) These characters specify the parameter by ASCII mnemonic. See 11 Mnemonic table.

(ENQ) This character indicates the end of the message, and that it is an enquiry.



The transmission of this message initiates a response procedure from the PL/X.

### 3.12.2 Valid response of the PL/X to this message

After the message has been sent, the computer expects to receive a reply from the PL/X. Providing the PL/X has successfully received the message in full, it responds in the following form: -

(STX) (C1) (C2) (D1) (D2) (D3) .... (DN) (ETX) (BCC)

Which constitutes a message defined as thus: -

(STX) start of text.

(C1)(C2) parameter specified by mnemonic

(D1 to DN) value of the requested parameter (string may be of any length as determined by the data).

The PL/X responds with the shortest message, which represents the data value. If the data value is an integer (part after decimal point is 0), then it does not send a decimal point. Trailing zeros after the decimal point are not sent.

(ETX) end of text

(BCC) verification digit, which is the character, generated by taking the exclusive OR of the ASCII values of all the characters transmitted after and excluding (STX) up to and including (ETX).

E.g. in a message with (D1 - DN) is 5 characters

(BCC) = (C1) EOR (C2) EOR (D1) EOR (D2) EOR (D3) EOR (D4) EOR (D5) EOR (ETX)

Where EOR = Exclusive OR

The computer must check this (BCC) before accepting this reply as valid. Also the software must be able to extract the check number from the data string taking into account the protocol of the data transmission.

NOTE: If the PL/X receives the message but does not recognise the mnemonic it will respond with (EOT). The (EOT) tells the computer to continue.

### 3.12.3 Further enquiry and termination

The computer then has three options: -

#### 1) Repeat Parameter Facility (NAK)

If the computer transmits a (NAK) after the valid reply, it causes the PL/X to repeat the parameter that was just received. This allows continuous monitoring of the same parameter without having to re-establish the connection.

#### 2) Scroll Mode Facility (ACK)

If the computer transmits an (ACK) after a valid reply, it causes the PL/X to fetch the next parameter from the parameter list. This facility enables the computer to continuously sequence through all the parameters of the PL/X.

#### 3) Terminate Communication (EOT)

The termination procedure is entered when the selection of a particular PL/X is no longer required or when a PL/X does not respond to a message or replies with an (EOT) character. The computer transmits an (EOT) character to enable all the PL/Xs on the data link to be responsive to the next GID-UID address parameter.

#### 3.12.4 No response to host computer

Under certain circumstances the computer may not receive a response from the PL/X. This could be due to any of the following reasons-.

- 1) Group/Unit address identifiers not recognised.
- 2) Communications loop failure perhaps due to noise or wrong baud rate being selected.
- 3) Hardware failure.
- 4) ASCII COMMS has not been selected using 188)PORT1 FUNCTION

In the first 3 cases the computer should be programmed to time-out, i.e. wait for a response for a short time (150 msec minimum) before trying again.

#### 3.12.5 Baud rate

This can be any of seven values: -

300, 600, 1200, 2400, 4800, 9600, 19200 baud

## 4 PL PILOT and SCADA (System Control And Data Acquisition) package

There is a proprietary PC based SCADA (System Control And Data Acquisition) package available which is fully configured to communicate with the PL/X range. This package provides many features, including.

PL/X Configuration	Data logging	Alarm logging	Recipe management
Multi-drop capability	Bar charts	Drawing package	Full parameter monitoring
Chart recording	Multi-instrument views	Multiple comm ports	Bit map graphics import

The SCADA package is designed by SPECVIEW, and may be downloaded from <http://www.specview.com/> free of charge from the internet for a demonstration. (There is also a demonstration dongle available that allows 2 hours per view).

SPECVIEW is the platform for the PL PILOT configuration tool.

Further details about this package are accessible from the entry page of the PL PILOT configuration tool.

PL PILOT runs on a standard PC (Windows 95 upwards). It can set any parameter value, make any legal internal connection, and monitor all the available parameters. It provides the user with block diagrams where each parameter may be quickly accessed and altered. The system allows recipes of drive configurations to be stored and/or down loaded as desired. It may also be operated off-line to develop and save recipes.

PL PILOT is also able to support up to 10 drives on one link. It can access all parameters, connections and diagnostics for each drive. It is able to display these from any drive or combinations of drives and send recipes to any drive on the link.

This powerful tool is available free of charge and is supplied on a CD with the PL/X.

The operating instructions for PL PILOT are contained within the tool itself. Click on the Help BUTTON.

To install from the CD follow the self launching instructions when the CD is inserted into the PC. From the net version you must first unzip it into a temporary directory. Then double click on Setup.exe.

For users that are installing for the first time select. 'Typical ' in the 'Setup type' dialog box.

For users that are installing the latest version on systems with an existing version select 'Repair'.

If you have existing recipes in the previous version these will automatically be retained in the latest version.

If you have to change any com port settings on the computer, or save changed serial link parameters on the PL/X, then you may need to turn the PL/X off and on again to clear the comms buffers of false data before the system will start communicating.

**Click on the Help **BUTTON** in the top right hand corner of the **PL PILOT** entry menu for further information.**

There is a suitable cable supplied to connect the PC COM 1 serial port to PL/X RS232 PORT1. (LA102595) 187)PORT1 BAUD RATE. Set to 19200 on the target PL/X, and in 'Options' / 'Setup COM Port' in PL PILOT. 188)PORT1 FUNCTION. Set to ASCII COMMS on the target PL/X.

Warning. PL PILOT may add up to 10mS to PL/X cycle times, which may affect the response of applications that require fast sampling. Eg SPINDLE ORIENTATE. To overcome this effect, reduce the baud rate.

## 5 FIELDBUS introduction

This section describes the FIELDBUS CONFIG menu. It is used to select parameters for transmitting to, or receiving from, the host controller using for example PROFIBUS protocol. Other protocols may also be used, depending on which comms option card is fitted to the PL/X. The host is not used for configuration.

Each PL/X source parameter selected for transmission (input to master) is configured on the PL/X using a GET FROM. Each PL/X target parameter (output from master) is configured on the PL/X using a GOTO.

1) Any PL/X parameter is available for selection as a source by each one of 8 GET FROMs (1 word each), + one group of 8 way bit packed logic value GET FROMs (1 word).

Any legal PL/X parameter is available for selection as a target by each one of 8 GOTOs (1 word each), + one group of 8 way bit packed logic value GOTOs (1 word).

2) The PL/X GOTO conflict checker automatically checks to see if the GOTO connections are accidentally configured by the user to a PIN with another PL/X GOTO already connected to it.

3) Reconfiguring the FIELDBUS for any PL/X, without stopping the master or other PL/X units, is possible.

4) The FIELDBUS configuration for each PL/X is held within the unit itself and is also retained in the parameter exchange file. 3 FIELDBUS configurations can be saved in each PL/X by using the 3 recipe pages.

### 5.1 CONFIGURATION / FIELDBUS CONFIG

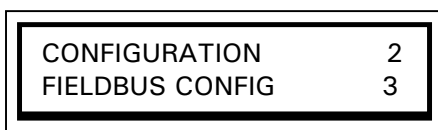

NOTE. The function of this sub-menu is the process of establishing connections between PL/X PINs and the PL/X FIELDBUS port. Hence it is located in the CONFIGURATION menu. The advantage of this is that it is located close to the CONFLICT HELP MENU.

The FIELDBUS CONFIG menu uses JUMPERS 1 - 8 with GET FROMs to connect the source PINs to the PL/X FIELDBUS transmitter, and JUMPERS 9 - 16 with GOTOs to connect the target PINs to the PL/X FIELDBUS receiver.

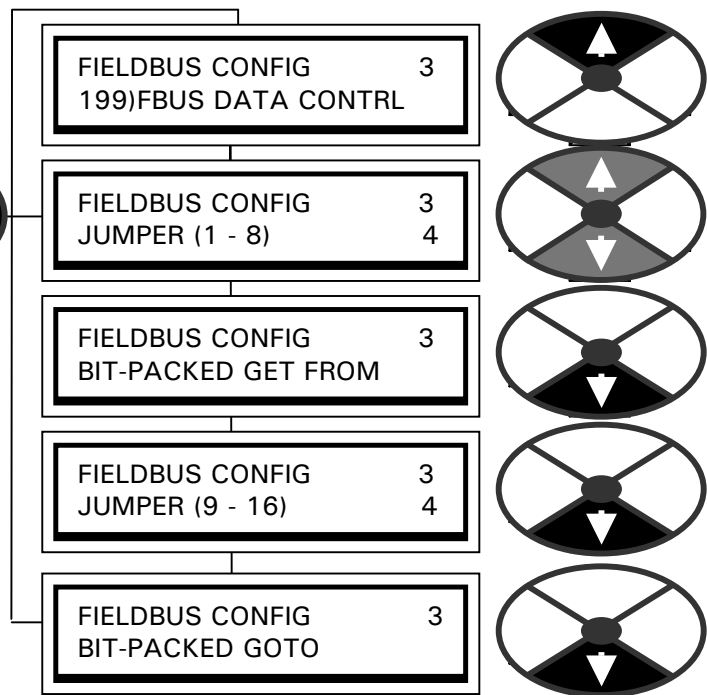

The BIT-PACKED GET FROM sub-menu contains 8 further JUMPERS to build a byte of logic sources. The BIT-PACKED GOTO sub-menu contains 8 further JUMPERS to build a byte of logic targets.

**IMPORTANT NOTE.** Please do not confuse: **FIELDBUS CONFIG jumpers used for selecting source and target PINs for FIELDBUS communications**, with PL/X configuration JUMPERS found in the **JUMPER CONNECTIONS** menu used for making internal connections between PINs. (See section 13.10 of the main product manual). **FIELDBUS CONFIG JUMPERS** and **JUMPER CONNECTIONS** are totally unrelated and independently usable tools. It was very convenient for the PL/X designers to use the JUMPER nomenclature for each task.

199)FBUS DATA CONTRL is used to set BIG/LITTLE ENDIAN, and OFF-LINE output CLEAR, or OFF-LINE output FREEZE mode, to suit user preferences.

There is also a hidden PIN 200)FBUS ON-LINE MON which is high when the fieldbus is actually on-line.

5.1.1 FIELDBUS CONFIG / JUMPER 1 - 8

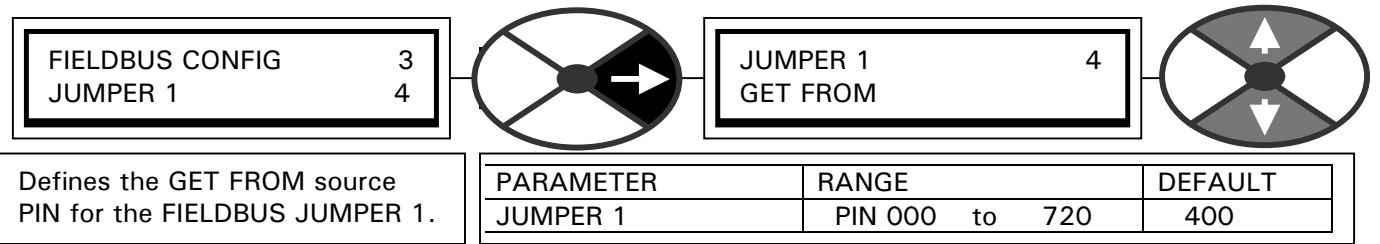

JUMPER 1 - 8 can be used for linear or logic values. If the host can decode bit packed words, then BIT PACKED GET FROM is available for efficient handling.

5.1.2 FIELDBUS CONFIG / BIT-PACKED GET FROM

BIT-PACKED GET FROM is divided into 8 bits for reading logic values in the PL/X using a GET FROM window.

The 8 bits are grouped into the lower byte for the FIELDBUS word, the higher byte being zero. (word = 0000 0000 J8,J7,J6,J5, J4,J3,J2,J1 )

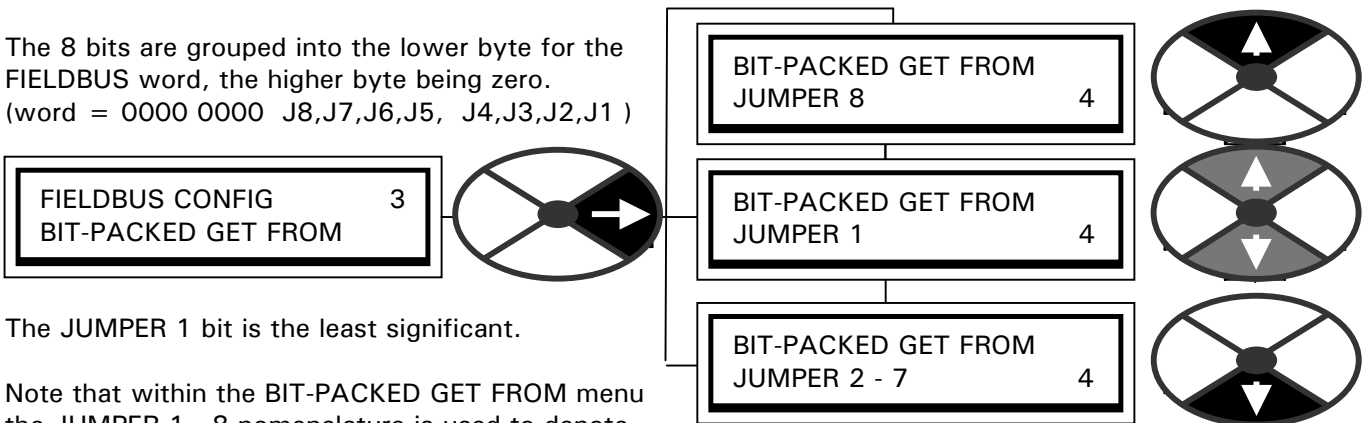

The JUMPER 1 bit is the least significant.

Note that within the BIT-PACKED GET FROM menu the JUMPER 1 - 8 nomenclature is used to denote the associated bits configured by each GETFROM window

Note. A logic or linear PL/X parameter may be connected. Non-zero (+ or -) values result in logic 1, zero results in logic 0.

5.1.3 Key features of FIELDBUS CONFIG JUMPERS 1 - 8 and BIT-PACKED GETFROM windows

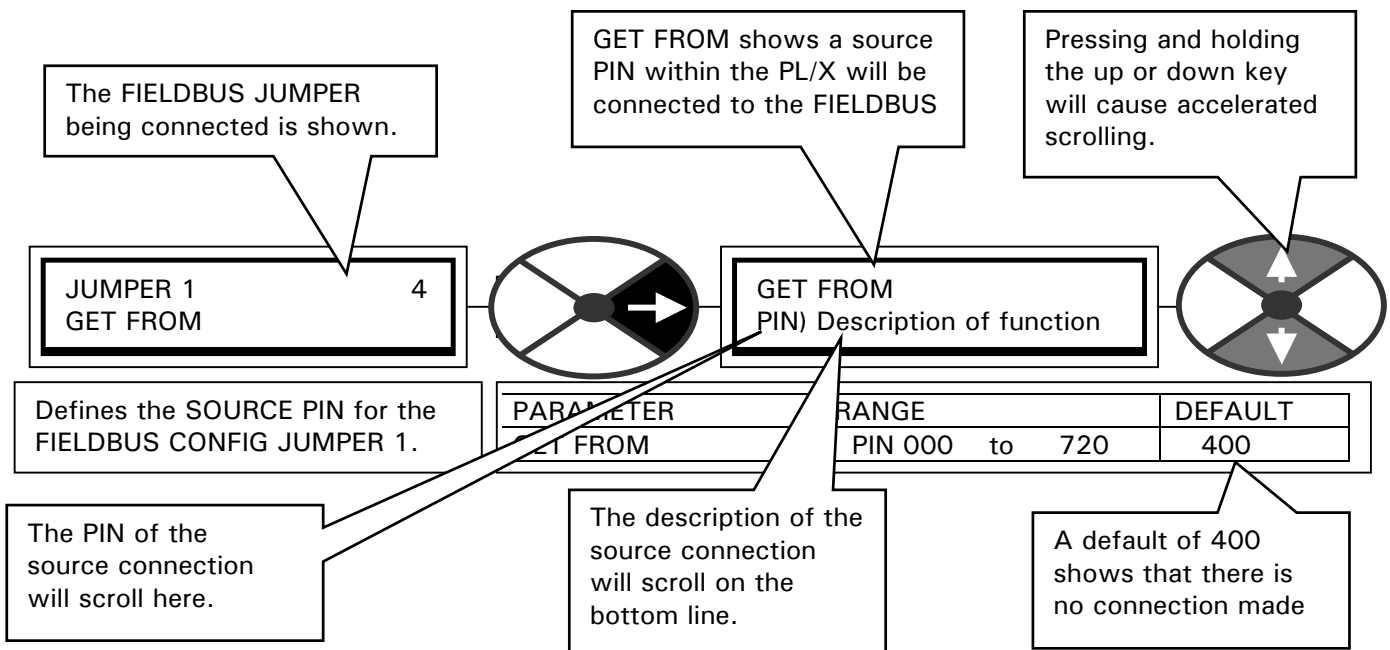

5.1.4 FIELDBUS CONFIG / JUMPER 9 - 16

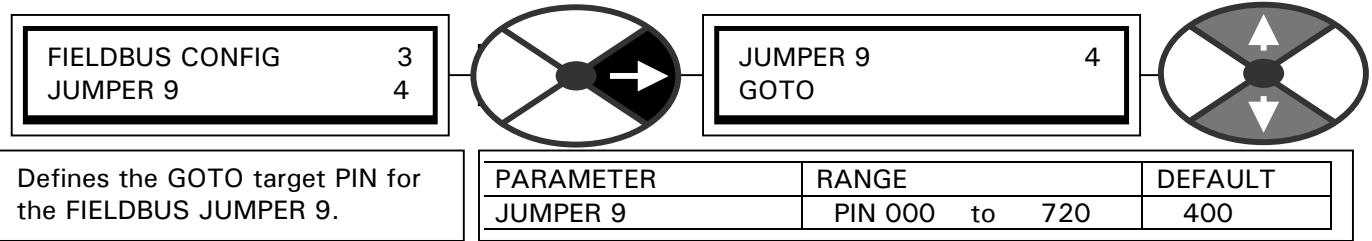

JUMPER 9 - 16 can target linear or logic PL/X parameters.

If the host can generate bit packed words, then the BIT PACKED GOTO is available for efficient handling.

5.1.5 FIELDBUS CONFIG / BIT PACKED GOTO

BIT-PACKED GOTO is divided into 8 bits for writing logic values in the PL/X using a GOTO window.

The 8 bits are grouped into the lower byte for the FIELD BUS word, the higher byte being zero.  
(word = 0000 0000 J8,J7,J6,J5, J4,J3,J2,J1 )

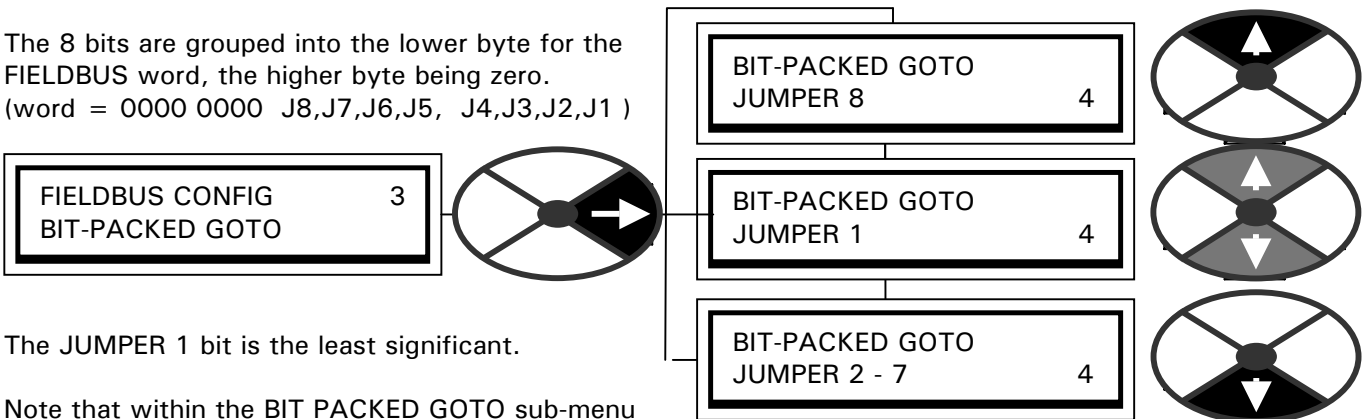

The JUMPER 1 bit is the least significant.

Note that within the BIT PACKED GOTO sub-menu the JUMPER 1 - 8 nomenclature is used to denote the associated bits configured by each GOTO.

BIT PACKED GOTOS can target linear as well as logic PL/X parameters.

When writing to a linear PL/X parameter a logic 1 results in + 1 count of target PIN resolution.

(Eg for target PIN % value of 2 decimal place resolution, logic 1 results in 0.01%, logic 0 results in 0.00% ).

5.1.6 Key features of FIELD BUS JUMPERS 9 - 16 and the BIT-PACKED GOTO windows

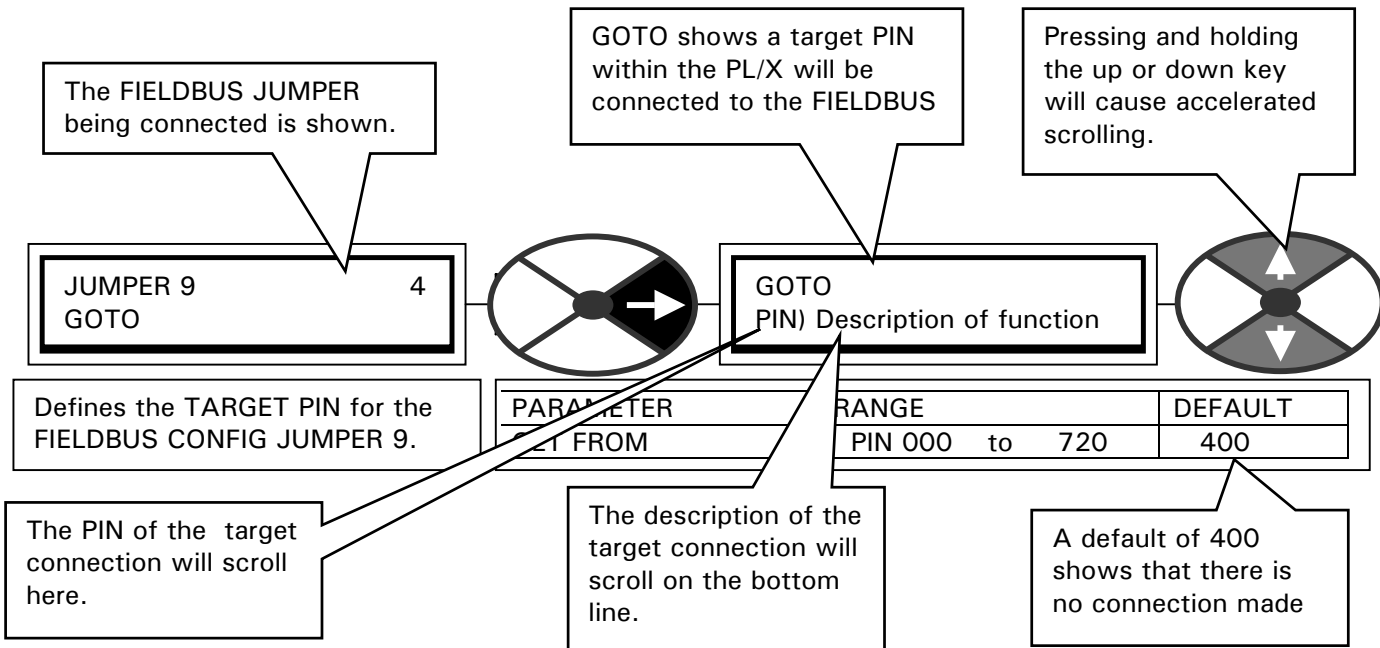

5.1.7 Automatic optimisation of network traffic.

The default input/output size is 2 input and 2 output words. This allows the use of 2 GETFROMS and 2 GOTOS. (The factory default is no connections made hence zeros will be displayed initially). Other possible input/output sizes are 4, 8, 16.

There are 2 groups of words. The input group for GETFROMS, and the output group for GOTOS. The PL/X will automatically select the smallest input group (2,4,8,16) of words that will accommodate all the configured GETFROM jumpers, and also smallest output group (2,4,8,16) of words that will accommodate all the configured GOTO jumpers. In this way the amount of redundant traffic is minimised as far as possible. Only Jumpers **not connected to 400)Block Disconnect** are counted, when the group size is being selected.

Example 1. Assuming jumper 1, 3, 7 (GETFROMS = input to master) and jumpers 9, 10, 11, 16 (GOTOS = output from master) are used. Then the input/output format will automatically be 4 plus 4. The unused input will be displayed by the master as zero, all the outputs will be utilised. **The inputs will always appear in ascending jumper order. The outputs will always appear in ascending jumper order.**

**IMPORTANT. The group format is not validated after a change in the number, or identity, of connected jumpers, until the new configuration is saved, and the control supply cycled off and on again.**

**If the number and identity of jumpers is unchanged, but the source or target PINs are altered, then the new source or target PINs are effective immediately without the need to cycle the control supply.**

5.1.8 FIELDBUS CONFIG JUMPER connections

FIELDBUS jumpers are used to configure connections from the FIELDBUS port to PINs within the PL/X. A FIELDBUS GOTO jumper receives data from the host via the FIELDBUS port and connects it to the selected target PIN in the PL/X.

A FIELDBUS GETFROM jumper reads the PL/X source PIN value, and connects it to the FIELDBUS port for transmission to the host.

FIELDBUS jumper connections can connect to any legal PINs including outputs, inputs, terminals and PINs within blocks. FIELDBUS GOTOS will automatically avoid outputs.

In the case of accidental connection to a PIN with another GOTO already connected (any type of GOTO including FIELDBUS), the GOTO CONFLICT CHECKER will issue a warning. See 5.3 CONFIGURATION / CONFLICT HELP MENU.

The GET FROM can also connect onto PINs that have already been connected using a GOTO or GET FROM.

**IMPORTANT NOTE.** Please do not confuse:

a) **FIELDBUS CONFIG jumpers used for selecting source and target PINs for FIELDBUS communications.** with

b) PL/X configuration JUMPERS found in the **JUMPER CONNECTIONS** menu used for making internal connections between PINs. (See section 13.10 of the main product manual).

**FIELDBUS CONFIG JUMPERS** and **JUMPER CONNECTIONS** are totally unrelated and independently usable tools. It was very convenient for the PL/X designers to use the JUMPER nomenclature for each task.

5.1.9 FIELDBUS CONFIG / Fieldbus data control

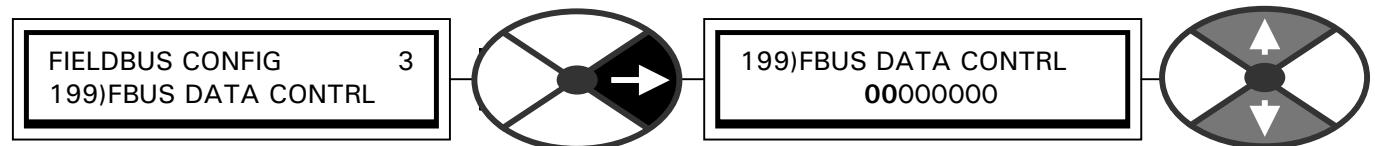

Bit0 off-line output clear or freeze  
Bit1 sets big/little endian

PARAMETER	RANGE	DEFAULT
FBUS DATA CONTRL	00000000 - 11000000	00000000

Bit 0 (Left hand bit) set to 0 for OFF-LINE output CLEAR. Set to 1 for OFF-LINE output FREEZE.

This sets the behaviour of the output target PINs in the event of a loss of communications.

Bit 1 (2<sup>nd</sup> from left) set to 0 for BIG ENDIAN. Set to 1 for LITTLE ENDIAN. (High/low word display order).

### 5.2 CONFIGURATION / ENABLE GOTO, GETFROM

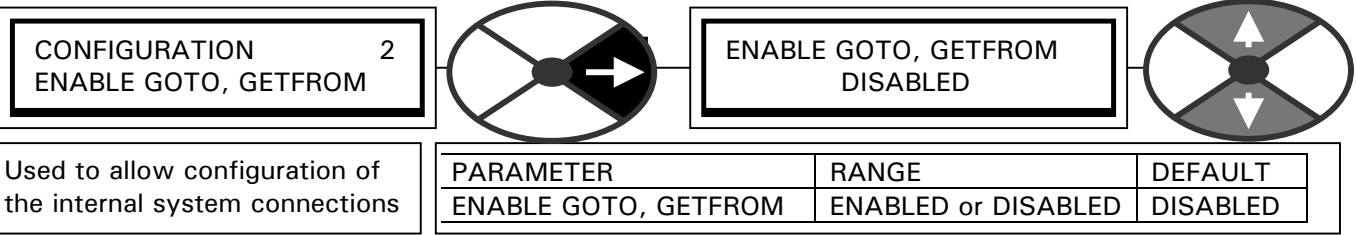

Used to allow configuration of the internal system connections

**Note.** After performing a GOTO or GETFROM connection, ensure you set this window to **DISABLED** or the drive will not run. **Note.** This must be set to **DISABLED** to allow communication with the Fieldbus.

When the window is set to **DISABLED** the automatic conflict checker starts checking to see if more than one GOTO connection has been made to any PIN (More than one GOTO would lead to a unwanted values at the target PIN). If it finds a conflict, the alarm message GOTO CONFLICT will appear on the bottom line.

### 5.3 CONFIGURATION / CONFLICT HELP MENU

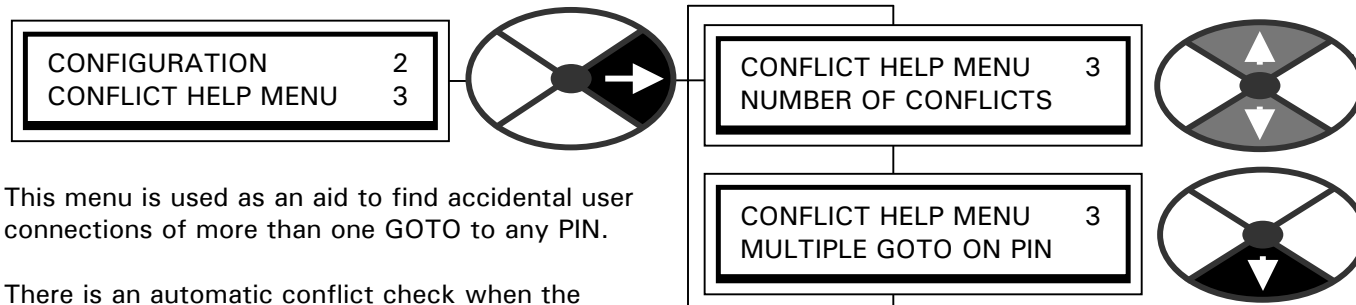

This menu is used as an aid to find accidental user connections of more than one GOTO to any PIN.

There is an automatic conflict check when the **ENABLE GOTO, GETFROM** is set to **DISABLED**. (This is done at the end of a configuration session). If a conflict is found, the display will give the alarm message **GOTO CONFLICT**. See 5.2 **CONFIGURATION / ENABLE GOTO, GETFROM**.

#### 5.3.1 CONFLICT HELP MENU / Number of conflicts

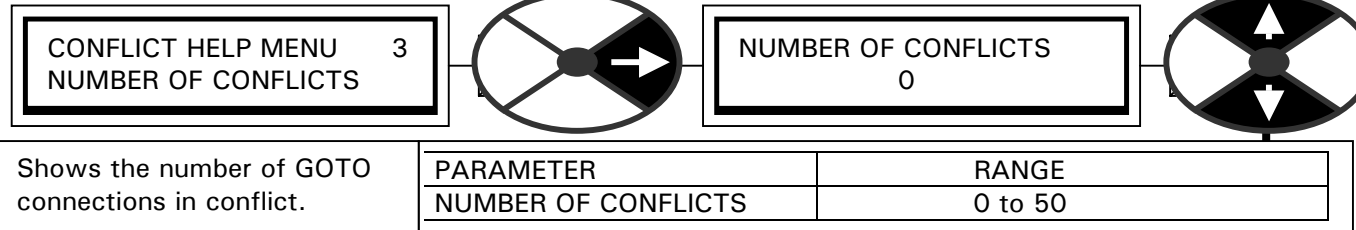

Shows the number of GOTO connections in conflict.

**Note,** there will be at least 2 conflicts for each conflict PIN. Removing one GOTO from the conflict PIN will reduce the conflict number by at least 2. This window has a branch hopping facility to the **MULTIPLE GOTO ON PIN** window.

#### 5.3.2 CONFLICT HELP MENU / Multiple GOTO conflict PIN identifier

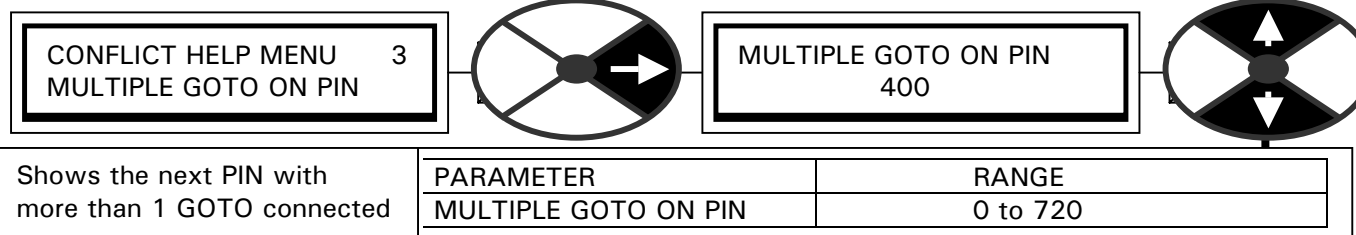

Shows the next PIN with more than 1 GOTO connected

**Note,** there will be at least 2 conflicts for each conflict PIN. Removing one GOTO from the conflict PIN will reduce the conflict number by 2. The number 400 is block disconnect and indicates no conflicts. This window has a branch hopping facility to the **NUMBER OF CONFLICTS** window.



## 5.4 Input / output mapping for configured parameters

### 5.4.1 FIELDBUS CONFIG JUMPERS 1 - 8 and BIT-PACKED GETFROM

These 9 parameters appear in sequence in the first 9 registers of the INPUT AREA.

### 5.4.2 FIELDBUS CONFIG JUMPERS 9 - 16 and BIT-PACKED GOTO

These 9 parameters appear in sequence in the first 9 registers of the OUTPUT AREA.

## 6 PL/X FIELDBUS hardware requirements

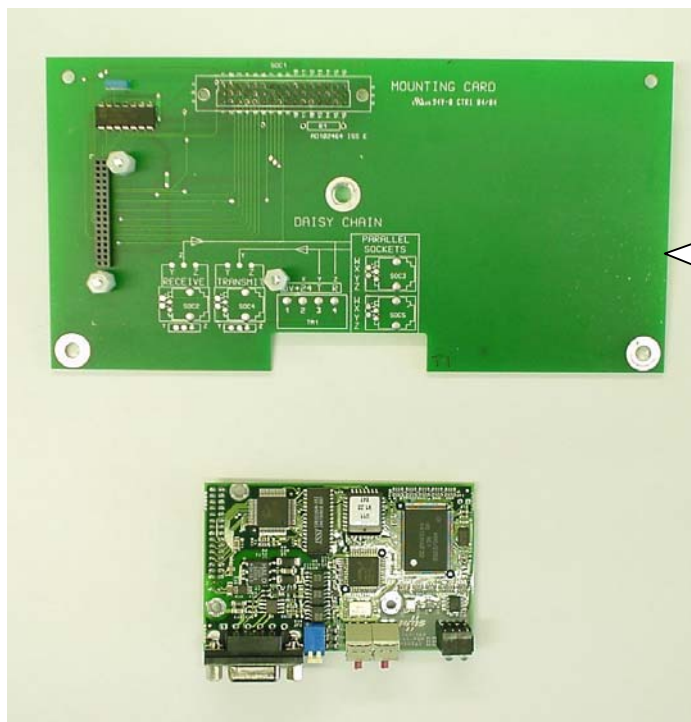

Mounting board for profibus card. This has a 48 way DIN plug for connection to the PL/X. (Part number LA102738)

PROFIBUS card with D-Type connector for PROFIBUS cable. This is mounted onto the mounting board.



PROFIBUS card mounted on 'mounting board for profibus card' and fixed onto PL/X control card. Note. The front bar is removed from the PL/X here for picture clarity only.

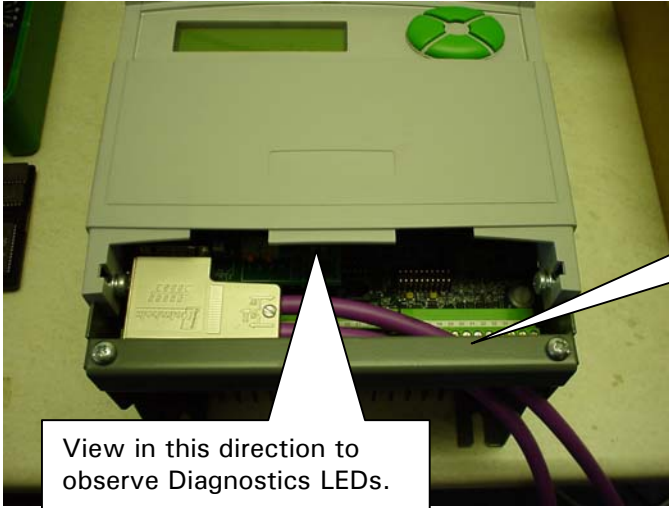

The front bar and top cover are in place. The PROFIBUS D-TYPE plug is shown plugged into the PROFIBUS card.

View in this direction to observe Diagnostics LEDs.

### 7 PROFIBUS card settings

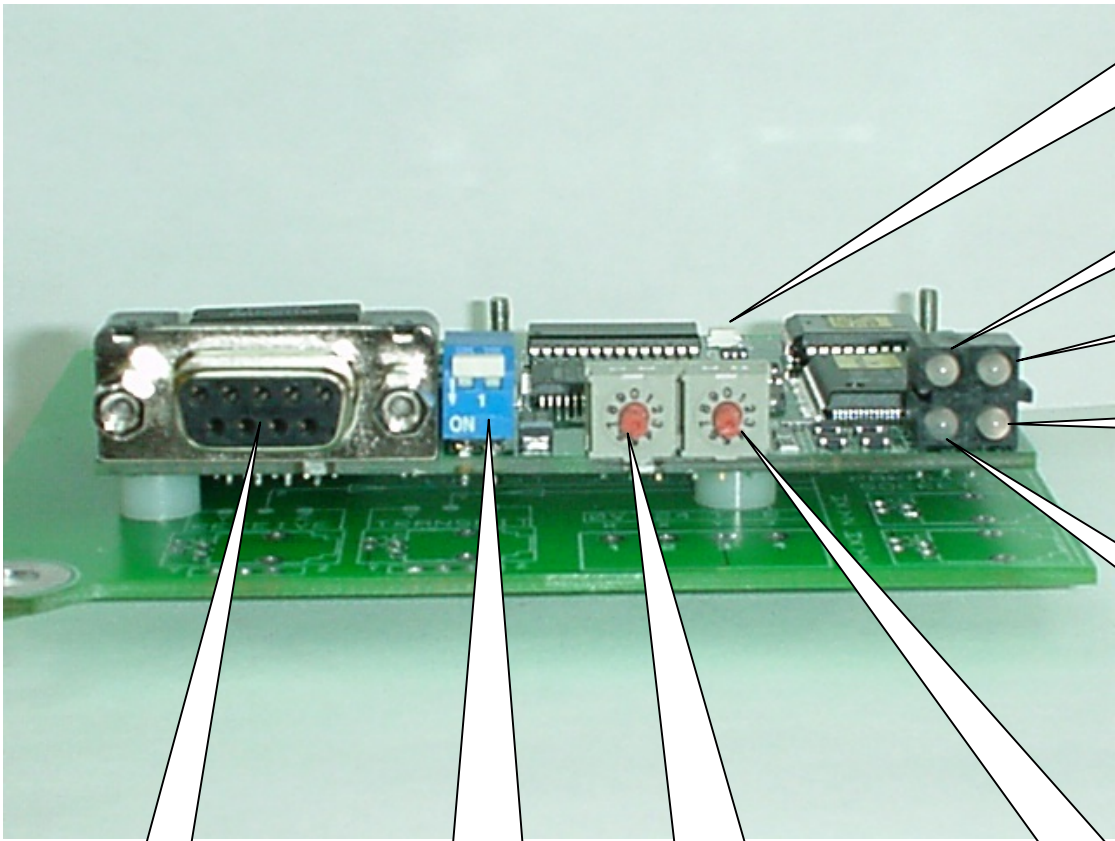

Bi-colour watchdog LED at top edge. See 7.1.1

1. Not used

2. On-Line

3. Off-Line

4. Fieldbus diagnostics See 7.1

D type connector

Termination switch See 7.3

Node address X 10 See 7.2

Node address X 1 See 7.2

The Profibus card is equipped with four LED's mounted at the front.

There is also a bi-colour watchdog LED located at the top edge of the Profibus card used for debugging purposes. This is only visible by viewing the PL/X from the bottom or by removing the front cover

## 7.1 Function of the LED's

1. Not used    2. On-Line    3. Off-Line    4. Fieldbus diagnostics

Name	Colour	Function
Fieldbus Diagnostics	Red	<p><b>Indicates certain faults on the Fieldbus side.</b></p> <p>Flashing Red 1 Hz - Error in configuration IN and/or OUT. The length set during initialisation of the Profibus card is not equal to the length set during configuration of the network.</p> <p>Flashing Red 2 Hz - Error in User Parameter. Data length/contents of the User Parameter data, set during initialisation of the Profibus card, is not equal to the length/contents set during configuration of the network.</p> <p>Flashing Red 4 Hz - Error in initialisation of the Profibus communication ASIC.</p> <p>Turned Off - No diagnostics present</p>
On-Line	Green	<p><b>Indicates that the Profibus card is On-Line on the fieldbus.</b></p> <p>Green - Profibus card is On-Line and data exchange is possible.</p> <p>Turned Off - Profibus card is not On-Line</p>
Off-Line	Red	<p><b>Indicates that the Profibus card is Off-Line on the fieldbus.</b></p> <p>Red -Profibus card is Off-Line and no data exchange is possible.</p> <p>Turned Off - Profibus card is not Off-Line</p>

### 7.1.1 Indications on Watchdog LED

There is also a bi-colour (red/green) watchdog LED on the Profibus card, indicating the status according to the table below. See 7 PROFIBUS card settings.

Watchdog function	Colour	Frequency
ASIC and FLASH ROM check fault	Red	2Hz
Profibus card not initialised	Green	2Hz
Profibus card initialised and running OK	Green	1Hz
RAM check fault	Red	1Hz
DPRAM check fault	Red	4Hz

CONFIGURATION / ENABLE GOTO, GETFROM

**Note.** After performing a GOTO or GETFROM connection, ensure you set this window to **DISABLED** or the drive will not run. Note also. This must be set to **DISABLED** to allow communication with the Fieldbus.

## 7.2 Node address

Before configuring the Profibus card the node address has to be set. This is done with two rotary switches on the Profibus card, which enable address settings from 1-99 in decimal format.

Looking at the front of the Profibus card, the leftmost switch is used for the ten setting and the rightmost switch is used for the setting of the integers. See section 7 PROFIBUS card settings.

Example:

Address = (Left Switch Setting x 10) + (Right Switch Setting x 1)

PLEASE NOTE: The node address can not be changed during operation.

### 7.3 Termination

The end nodes in a Profibus-DP network have to be terminated to avoid reflections on the bus line. The Profibus card is equipped with a termination switch to accomplish this in an easy way. See 7 PROFIBUS card settings.

If the Profibus card is used as the first or last Profibus card in a network the termination switch has to be in ON position.

Otherwise the switch has to be in the OFF position.

PLEASE NOTE: If an external termination connector is used the switch must be in the OFF position.

Termination switch state	Function
Termination switch ON	Bus termination enabled  If the Profibus card is the last or first Profibus card on a network, the bus termination has to be set on, or an external termination connector has to be used
Termination switch OFF	Bus termination disabled

## 8 Record of Comms manual modifications

Manual Version	Description of change	Reason for change	Paragraph reference	Date	Software version
4.04	First publication of Serial Comms Manual			May 2001	4.01/2/3/4
4.05	Add information about USB to RS232 convertors. PL PILOT version 4.05 able to multi-drop to 10 units ADD PIN132)ENCODER RPM ADD PIN714)IN SLACK FLAG PINs 193)PORT1 GROUP ID and 194)PORT1 UNIT ID now read/write	Improve manual Improve functionality Improve functionality Improve functionality  Allows address manipulation via comms link	2.2 4 8 8  8	July 2001	4.05
5.01	Add section on Fieldbus configuration	Implementing Profibus comms.	5	Jan 2002	5.01
5.02	Network optimisation PIN 199)FBUS DATA CONTRL function added  PIN 200)FBUS ON-LINE MON	Improve network utilisation To allow clear or freeze with comms loss and choice of big endian / little endian data format. Flag to indicate fieldbus on-line.	5.1.7 5.1.9  5.1	June 2002	5.02
5.12	Software for future Ethernet options added.	Improved functionality.		Nov 200	5.11
5.12	No functional changes			Jan 2003	5.12
5.14	No functional changes			Sep 04	5.14

## 9 Record of Comms bug fixes

Manual Version	Description of change	Reason for change	Paragraph reference	Date	Software version
----------------	-----------------------	-------------------	---------------------	------	------------------

This record only applies to Serial Comms. Please refer also to the product manuals for other bug fixes.

## 10 Changes to product since manual publication

Any new features that affect the existing functioning of the unit, that have occurred since the publication of the manual, will be recorded here.

## 11 Mnemonic table

Every parameter PIN in the PL/X has an ASCII mnemonic

The ASCII mnemonic (Mn) is made up of 2 HEX characters

There are 2 ways the comms link uses this association.

Sending data.

(Ro indicates Read only).

The host transmits the ASCII mnemonic followed by the data. The data is placed in the associated PIN.

Making an enquiry or polling.

The host makes an enquiry by sending an ASCII mnemonic. The PL/X responds by sending the data held in the associated PIN.

Mn		PARAMETER
AA		
AB	Ro	2)RATED ARM AMPS
AC		3)CURRENT LIMIT(%)
AD	Ro	4)RATED FIELD AMPS
AE		5)BASE RATED RPM
AF		6)DESIRED MAX RPM
AG		7)ZERO SPD OFFSET
AH		8)MAX TACHO VOLTS
AI		9)SPEED FBK TYPE
AJ		10)QUADRATURE ENABLE
AK		11)ENCODER LINES
AL		12)MOT/ENC SPD RATIO
AM		13)ENCODER SIGN
AN		14)IR COMPENSATION
AO		15)FIELD CUR FB TRIM
AP		16)ARM VOLTS TRIM
AQ		17)ANALOG TACHO TRIM
AR		18)RATED ARM VOLTS
AS		19)EL1/2/3 RATED AC
AT		20)MOTOR 1,2 SELECT
AU	Ro	21)RAMP OP MONITOR
AV		22)FORWARD UP TIME
AW		23)FORWARD DWN TIME
AX		24)REVERSE UP TIME
AY		25)REVERSE DOWN TIME
AZ		26)RAMP INPUT
Aa		27)FORWARD MIN SPEED
Ab		28)REVERSE MIN SPEED
Ac		29)RAMP AUTO PRESET
Ad		30)RAMP EXT PRESET
Ae		31)RAMP PRESET VALUE
Af		32)RAMP S-PROFILE %
Ag		33)RAMP HOLD
Ah		34)RAMPING THRESHOLD
Ai	Ro	35)RAMPING FLAG
Aj		36) R
Ak		37)JOG SPEED 1
Al		38)JOG SPEED 2
Am		39)SLACK SPEED 1
An		40)SLACK SPEED 2
Ao		41)CRAWL SPEED
Ap		42)JOG MODE SELECT
Aq		43)JOG/SLACK RAMP
Ar		44) R
As	Ro	45)MP OP MONITOR
At		46)MP UP TIME
Au		47)MP DOWN TIME
Av		48)MP UP COMMAND

Mn		PARAMETER
Aw		49)MP DOWN COMMAND
Ax		50)MP MAX CLAMP
Ay		51)MP MIN CLAMP
Az		52)MP PRESET
BA		53)MP PRESET VALUE
BB		54)MP MEMORY BOOT-UP
BC		55) R
BD		56)STOP RAMP TIME
BE		57)STOP TIME LIMIT
BF		58)LIVE DELAY MODE
BG		59)DROP-OUT SPEED
BH		60)DROP-OUT DELAY
BI		61) R
BJ		62)INT SPEED REF 1
BK		63)SPEED REF 2
BL		64)SPEED/ REF 3 MON
BM		65)RAMPED SPD REF 4
BN		66)SPD/CUR REF3 SIGN
BO		67)SPD/CUR RF3 RATIO
BP		68) R
BQ		69)MAX POS SPEED REF
BR		70)MAX NEG SPEED REF
BS		71)SPEED PROP GAIN
BT		72)SPEED INT T.C.
BU		73)SPEED INT RESET
BV		74)SPD ADPT LO BRPNT
BW		75)SPD ADPT HI BRPNT
BX		76)LO BRPNT PRP GAIN
BY		77)LO BRPNT INT T.C.
BZ		78)INT % DURING RAMP
Ba		79)SPD ADAPT ENABLE
Bb		80) R
Bc		81)CUR CLAMP SCALER
Bd		82)O/LOAD % TARGET
Be		83)O/LOAD RAMP TIME
Bf		84)I PROFILE ENABLE
Bg		85)SPD BRPNT AT HI I
Bh		86)SPD BRPNT AT LO I
Bi		87)CUR LIMIT AT LO I
Bj		88)DUAL I CLAMP ENBL
Bk		89)UPPER CUR CLAMP
Bl		90)LOWER CUR CLAMP
Bm		91)EXTRA CUR REF
Bn		92)AUTOTUNE ENABLE
Bo		93)CUR PROP GAIN
Bp		94)CUR INT GAIN
Bq		95)CUR DISCONTINUITY
Br		96)4-QUADRANT MODE

Mn		PARAMETER
Bs		97)SPD BYPASS CUR EN
Bt		98) R
Bu		99)FIELD ENABLE
Bv		100)FIELD VOLTS OP %
Bw		101)FIELD PROP GAIN
Bx		102)FIELD INT GAIN
By		103)FLD WEAK ENABLE
Bz		104)FLD WK PROP GAIN
CA		105)FLD WK INT TC ms
CB		106)FLD WK DRV TC ms
CC		107)FLD WK FB DRV ms
CD		108)FLD WK FB INT ms
CE		109)SPILLOVER AVF %
CF		110)MIN FLD CURRENT
CG		111)STANDBY FLD ENBL
CH		112)STANDBY FLD CUR
CI		113)FLD QUENCH DELAY
CJ		114)FIELD REFERENCE
CK		115)STANDSTILL ENBL
CL		116)ZERO REF START
CM		117)ZERO INTLK SPD %
CN		118)ZERO INTLK CUR %
CO	Ro	119)AT ZERO REF FLAG
CP	Ro	120)AT ZERO SPD FLAG
CQ	Ro	121)AT STANDSTILL
CR		122)ZERO SPEED LOCK
CS	Ro	123)TOTAL SPD REF MN
CT	Ro	124)SPEED DEMAND MON
CU	Ro	125)SPEED ERROR MON
CV	Ro	126)ARM VOLTS MON
CW	Ro	127)ARM VOLTS % MON
CX	Ro	128)BACK EMF % MON
CY	Ro	129)TACHO VOLTS MON
CZ	Ro	130)MOTOR RPM MON
Ca	Ro	131)SPEED FBK MON
Cb	Ro	132)ENCODER RPM MON
Cc	Ro	133)ARM CUR DEM MON
Cd	Ro	134)ARM CUR % MON
Ce	Ro	135)ARM CUR AMPS MN
Cf	Ro	136)UPPER CUR LIM MN
Cg	Ro	137)LOWER CUR LIM MN
Ch	Ro	138)ACTUAL UPPER LIM
Ci	Ro	139)ACTUAL LOWER LIM
Cj	Ro	140)O/LOAD LIMIT MON
Ck	Ro	141)AT CURRENT LIMIT
Cl		142) R
Cm	Ro	143)FIELD DEMAND MON
Cn	Ro	144)FIELD CUR % MON

Mn		PARAMETER
Co	Ro	145)FLD CUR AMPS MON
Cp	Ro	146)ANGLE OF ADVANCE
Cq	Ro	147)FIELD ACTIVE MON
Cr		148) R
Cs		149) R
Ct	Ro	150)UIP2 (T2) MON
Cu	Ro	151)UIP3 (T3) MON
Cv	Ro	152)UIP4 (T4) MON
Cw	Ro	153)UIP5 (T5) MON
Cx	Ro	154)UIP6 (T6) MON
Cy	Ro	155)UIP7 (T7) MON
Cz	Ro	156)UIP8 (T8) MON
DA	Ro	157)UIP9 (T9) MON
DB		158) R
DC	Ro	159)AOP1 (T10) MON
DD	Ro	160)AOP2 (T11) MON
DE	Ro	161)AOP3 (T12) MON
DF	Ro	162)UIP 23456789
DG	Ro	163)DIP 12341234 DIO
DH	Ro	164)DOP 123TRJSC CIP
DI	Ro	165) + ARM BRIDGE FLAG
DJ	Ro	166)DRIVE START FLAG
DK	Ro	167)DRIVE RUN FLAG
DL	Ro	168)RUNNING MODE MON
DM	Ro	169)EL1/2/3 RMS MON
DN	Ro	170)DC KILOWATTS MON
DO		171)SPD TRIP ENABLE
DP		172)SPEED TRIP TOL
DQ		173)FLD LOSS TRIP EN
DR		174)DOP SCCT TRIP EN
DS		175)MISSING PULSE EN
DT		176)REF EXCH TRIP EN
DU		177)OVERSPEED DELAY
DV		178)STALL TRIP ENBL
DW		179)STALL CUR LEVEL
DX		180)STALL DELAY TIME
DY	Ro	181)ACTIVE TRIP MON
DZ	Ro	182)STORED TRIP MON
Da		183)EXT TRIP RESET
Db		184) R
Dc		185) R
Dd		186) R
De		187)PORT1 BAUD RATE
Df		188)PORT1 FUNCTION
Dg		189)REF XC SLV RATIO
Dh		190)REF XC SLV SIGN
Di	Ro	191)REF XC SLAVE MON
Dj	Ro	192)REF XC MASTER MN
Dk		193)PORT1 GROUP ID
DI		194)PORT1 UNIT ID
Dm		195)PORT1 ERROR CODE
Dn		196)P1 DOP3 RTS MODE
Do		197) R
Dp		198) R
Dq		199)FBUS DATA CONTRL
Dr		200)FBUS ON-LINE MON
Ds		201) R
Dt		202) R
Du		203) R
Dv		204) R
Dw		205) R
Dx		206) R
Dy		207) R
Dz		208) R
EA		209) R
EB		210) R
EC		211) R
ED		212) R

Mn		PARAMETER
EE		213) R
EF		214) R
EG		215) R
EH		216) R
EI		217) R
EJ		218) R
EK		219) R
EL		220) R
EM		221) R
EN		222) R
EO		223) R
EP		224) R
EQ		225) R
ER		226) R
ES		227) R
ET		228) R
EU		229) R
EV		230) R
EW		231) R
EX		232) R
EY		233) R
EZ		234) R
Ea		235) R
Eb		236) R
Ec		237) R
Ed		238) R
Ee		239) R
Ef		240)MARKER ENABLE
Eg		241)MARKER OFFSET
Eh		242)POSITION REF
Ei	Ro	243)MARKER FREQ MON
Ej	Ro	244)IN POSITION FLAG
Ek		245) R
El		246) R
Em		247) R
En		248) R
Eo		249) R
Ep		250)Iarm OP RECTIFY
Eq		251)AOP1 DIVIDER
Er		252)AOP1 OFFSET
Es		253)AOP1 RECTIFY EN
Et		254)AOP2 DIVIDER
Eu		255)AOP2 OFFSET
Ev		256)AOP2 RECTIFY EN
Ew		257)AOP3 DIVIDER
Ex		258)AOP3 OFFSET
Ey		259)AOP3 RECTIFY EN
Ez		260)SCOPE OP SELECT
FA		261)DOP1 RECTIFY EN
FB		262)DOP1 THRESHOLD
FC		263)DOP1 INVERT MODE
FD		264)DOP2 RECTIFY EN
FE		265)DOP2 THRESHOLD
FF		266)DOP2 INVERT MODE
FG		267)DOP3 RECTIFY EN
FH		268)DOP3 THRESHOLD
FI		269)DOP3 INVERT MODE
FJ		270) R
FK		271)DIO1 OP MODE
FL		272)DIO1 RECTIFY EN
FM		273)DIO1 THRESHOLD
FN		274)DIO1 INVERT MODE
FO		275)DIO1 IP HI VALUE
FP		276)DIO1 IP LO VALUE
FQ		277)DIO2 OP MODE
FR		278)DIO2 RECTIFY EN
FS		279)DIO2 THRESHOLD
FT		280)DIO2 INVERT MODE

Mn		PARAMETER
FU		281)DIO2 IP HI VALUE
FV		282)DIO2 IP LO VALUE
FW		283)DIO3 OP MODE
FX		284)DIO3 RECTIFY EN
FY		285)DIO3 THRESHOLD
FZ		286)DIO3 INVERT MODE
Fa		287)DIO3 IP HI VALUE
Fb		288)DIO3 IP LO VALUE
Fc		289)DIO4 OP MODE
Fd		290)DIO4 RECTIFY EN
Fe		291)DIO4 THRESHOLD
Ff		292)DIO4 INVERT MODE
Fg		293)DIO4 IP HI VALUE
Fh		294)DIO4 IP LO VALUE
Fi		295) R
Fj		296)DIGITAL POST 1
Fk		297)DIGITAL POST 2
Fl		298)DIGITAL POST 3
Fm		299)DIGITAL POST 4
Fn		300)ANALOG POST 1
Fo		301)ANALOG POST 2
Fp		302)ANALOG POST 3
Fq		303)ANALOG POST 4
Fr		304) R
Fs		305)ANDED RUN
Ft		306)ANDED JOG
Fu		307)ANDED START
Fv		308)INTERNAL RUN IP
Fw		309) R
Fx		310)DIP1 IP HI VALUE
Fy		311)DIP1 IP LO VALUE
Fz		312)DIP2 IP HI VALUE
GA		313)DIP2 IP LO VALUE
GB		314)DIP3 IP HI VALUE
GC		315)DIP3 IP LO VALUE
GD		316)DIP4 IP HI VALUE
GE		317)DIP4 IP LO VALUE
GF		318)RUN IP HI VALUE
GG		319)RUN IP LO VALUE
GH		320)UIP2 IP RANGE
GI		321)UIP2 IP OFFSET
GJ		322)UIP2 CAL RATIO
GK		323)UIP2 MAX CLAMP
GL		324)UIP2 MIN CLAMP
GM		325)UIP2 HI VAL OP1
GN		326)UIP2 LO VAL OP1
GO		327)UIP2 HI VAL OP2
GP		328)UIP2 LO VAL OP2
GQ		329)UIP2 THRESHOLD
GR		330)UIP3 IP RANGE
GS		331)UIP3 IP OFFSET
GT		332)UIP3 CAL RATIO
GU		333)UIP3 MAX CLAMP
GV		334)UIP3 MIN CLAMP
GW		335)UIP3 HI VAL OP1
GX		336)UIP3 LO VAL OP1
GY		337)UIP3 HI VAL OP2
GZ		338)UIP3 LO VAL OP2
Ga		339)UIP3 THRESHOLD
Gb		340)UIP4 IP RANGE
Gc		341)UIP4 IP OFFSET
Gd		342)UIP4 CAL RATIO
Ge		343)UIP4 MAX CLAMP
Gf		344)UIP4 MIN CLAMP
Gg		345)UIP4 HI VAL OP1
Gh		346)UIP4 LO VAL OP1
Gi		347)UIP4 HI VAL OP2
Gj		348)UIP4 LO VAL OP2

Mn		PARAMETER
Gk		349)UIP4 THRESHOLD
Gl		350)UIP5 IP RANGE
Gm		351)UIP5 IP OFFSET
Gn		352)UIP5 CAL RATIO
Go		353)UIP5 MAX CLAMP
Gp		354)UIP5 MIN CLAMP
Gq		355)UIP5 HI VAL OP1
Gr		356)UIP5 LO VAL OP1
Gs		357)UIP5 HI VAL OP2
Gt		358)UIP5 LO VAL OP2
Gu		359)UIP5 THRESHOLD
Gv		360)UIP6 IP RANGE
Gw		361)UIP6 IP OFFSET
Gx		362)UIP6 CAL RATIO
Gy		363)UIP6 MAX CLAMP
Gz		364)UIP6 MIN CLAMP
HA		365)UIP6 HI VAL OP1
HB		366)UIP6 LO VAL OP1
HC		367)UIP6 HI VAL OP2
HD		368)UIP6 LO VAL OP2
HE		369)UIP6 THRESHOLD
HF		370)UIP7 IP RANGE
HG		371)UIP7 IP OFFSET
HH		372)UIP7 CAL RATIO
HI		373)UIP7 MAX CLAMP
HJ		374)UIP7 MIN CLAMP
HK		375)UIP7 HI VAL OP1
HL		376)UIP7 LO VAL OP1
HM		377)UIP7 HI VAL OP2
HN		378)UIP7 LO VAL OP2
HO		379)UIP7 THRESHOLD
HP		380)UIP8 IP RANGE
HQ		381)UIP8 IP OFFSET
HR		382)UIP8 CAL RATIO
HS		383)UIP8 MAX CLAMP
HT		384)UIP8 MIN CLAMP
HU		385)UIP8 HI VAL OP1
HV		386)UIP8 LO VAL OP1
HW		387)UIP8 HI VAL OP2
HX		388)UIP8 LO VAL OP2
HY		389)UIP8 THRESHOLD
HZ		390)UIP9 IP RANGE
Ha		391)UIP9 IP OFFSET
Hb		392)UIP9 CAL RATIO
Hc		393)UIP9 MAX CLAMP
Hd		394)UIP9 MIN CLAMP
He		395)UIP9 HI VAL OP1
Hf		396)UIP9 LO VAL OP1
Hg		397)UIP9 HI VAL OP2
Hh		398)UIP9 LO VAL OP2
Hi		399)UIP9 THRESHOLD
Hj		400)Block Disconnect
Hk	Ro	401)SUMMER1 OP MON
HI		402)SUMMER1 SIGN1
Hm		403)SUMMER1 SIGN2
Hn		404)SUMMER1 RATIO1
Ho		405)SUMMER1 RATIO2
Hp		406)SUMMER1 DIVIDER1
Hq		407)SUMMER1 DIVIDER2
Hr		408)SUMMER1 INPUT1
Hs		409)SUMMER1 INPUT2
Ht		410)SUMMER1 INPUT3
Hu		411)SUMMER1 DEADBND
Hv		412)SUMMER1 OP INVRT
Hw		413)SUMMER1 CLAMP
Hx		414) R
Hy	Ro	415)SUMMER2 OP MON
Hz		416)SUMMER2 SIGN1

Mn		PARAMETER
IA		417)SUMMER2 SIGN2
IB		418)SUMMER2 RATIO1
IC		419)SUMMER2 RATIO2
ID		420)SUMMER2 DIVIDER1
IE		421)SUMMER2 DIVIDER2
IF		422)SUMMER2 INPUT1
IG		423)SUMMER2 INPUT2
IH		424)SUMMER2 INPUT3
II	Ro	BABE (instrument identifier)
IJ		425)SUMMER2 DEADBND
IK		426)SUMMER2 OP INVRT
IL		427)SUMMER2 CLAMP
IM	Ro	429)PID1 OP MONITOR
IN		430)PID1 INPUT1
IO		431)PID1 RATIO1
IP		432)PID1 DIVIDER1
IQ		433)PID1 INPUT2
IR		434)PID1 RATIO2
IS		435)PID1 DIVIDER2
IT		436)PID1 PROP GAIN
IU		437)PID1 INTEGRAL TC
IV		438)PID1 DERIV TC
IW		439)PID1 FILTER TC
IX		440)PID1 INT PRESET
IY		441)PID1 PRESET VAL
IZ		442)PID1 RESET
Ia		443)PID1 POS CLAMP
Ib		444)PID1 NEG CLAMP
Ic		445)PID1 OUTPUT TRIM
Id		446)PID1 PROFL MODE
Ie		447)PID1 MIN PROP GN
If		448)PID1 X-AXIS MIN
Ig	Ro	449)PID1 PROFILED GN
Ih	Ro	450)PID1 CLAMP FLAG
Ii	Ro	451)PID1 ERROR MON
Ij	Ro	452)PID2 OP MONITOR
Ik		453)PID2 INPUT1
Il		454)PID2 RATIO1
Im		455)PID2 DIVIDER1
In		456)PID2 INPUT2
Io		457)PID2 RATIO2
Ip		458)PID2 DIVIDER2
Iq		459)PID2 PROP GAIN
Ir		460)PID2 INTEGRAL TC
Is		461)PID2 DERIV TC
It		462)PID2 FILTER TC
Iu		463)PID2 INT PRESET
Iv		464)PID2 PRESET VAL
Iw		465)PID2 RESET
Ix		466)PID2 POS CLAMP
Iy		467)PID2 NEG CLAMP
Iz		468)PID2 OUTPUT TRIM
JA		469)PID2 PROFL MODE
JB		470)PID2 MIN PROP GN
JC		471)PID2 X-AXIS MIN
JD	Ro	472)PID2 PROFILED GN
JE	Ro	473)PID2 CLAMP FLAG
JF	Ro	474)PID2 ERROR MON
JG	Ro	475)PROFILE Y OP MON
JH		476)PROFILER MODE
JI		477)PROFLR Y AT Xmin
JJ		478)PROFLR Y AT Xmax
JK		479)PROFILER Xmin
JL		480)PROFILER Xmax
JM		481)PROFLR X RECTIFY
JN		482) R
JO	Ro	483)DIAMETER OP MON
JP		484)DIA WEB SPEED IP

Mn		PARAMETER
JQ		485)DIA REEL SPD IP
JR		486)DIAMETER MIN
JS		487)DIA MIN SPEED
JT		488)DIAMETER HOLD
JU		489)DIA FILTER TC
JV		490)DIAMETER PRESET
JW		491)DIA PRESET VALUE
JX		492)DIA WEB BRK THR.
JY		493)DIA MEM BOOT-UP
JZ	Ro	494)TOTAL TENSION MN
Ja		495)TENSION REF
Jb		496)TAPER STRENGTH
Jc		497)HYPERBOLIC TAPER
Jd		498)TENSION TRIM IP
Je	Ro	499)TAPERED TENS.MON
Jf	Ro	500)TORQUE DEMND MN
Jg		501)TORQUE TRIM IP
Jh		502)STICTION COMP
Ji		503)STIC.WEB SPD THR
Jj		504)STATIC FRICTION
Jk		505)DYNAMIC FRICTION
Jl		506)FRICTION SIGN
Jm		507)FIXED INERTIA
Jn		508)VARIABLE INERTIA
Jo		509)MATERIAL WIDTH
Jp		510)ACCEL LINE SPEED
Jq		511)ACCEL SCALER
Jr		512)ACCEL INPUT/MON
Js		513)ACCEL FILTER TC
Jt		514)TENSION DEM IP
Ju		515)TENSION SCALER
Jv		516)TORQUE MEM SEL
Jw		517)TORQUE MEM INPUT
Jx		518)TENSION ENABLE
Jy		519)OVER/UNDERWIND
Jz	Ro	520)INERTIA COMP MON
KA		521) R
KB		522) R
KC	Ro	523)PRESET OP MON
KD		524)PRESET SEL1(LSB)
KE		525)PRESET SELECT 2
KF		526)PRESET SEL3(MSB)
KG		527)PR.VALUE FOR 000
KH		528)PR.VALUE FOR 001
KI		529)PR.VALUE FOR 010
KJ		530)PR.VALUE FOR 011
KK		531)PR.VALUE FOR 100
KL		532)PR.VALUE FOR 101
KM		533)PR.VALUE FOR 110
KN		534)PR.VALUE FOR 111
KO		535) R
KP		536) R
KQ		537) R
KR		538) R
KS		539) R
KT		540) R
KU		541) R
KV		542) R
KW		543) R
KX		544)MULTIFUN1 MODE
KY		545)MULTIFUN1 OP SEL
KZ		546)MULTIFUN2 MODE
Ka		547)MULTIFUN2 OP SEL
Kb		548)MULTIFUN3 MODE
Kc		549)MULTIFUN3 OP SEL
Kd		550)MULTIFUN4 MODE
Ke		551)MULTIFUN4 OP SEL
Kf		552)MULTIFUN5 MODE



Mn		PARAMETER
Kg		553)MULTIFUN5 OP SEL
Kh		554)MULTIFUN6 MODE
Ki		555)MULTIFUN6 OP SEL
Kj		556)MULTIFUN7 MODE
Kk		557)MULTIFUN7 OP SEL
Kl		558)MULTIFUN8 MODE
Km		559)MULTIFUN8 OP SEL
Kn	Ro	560)LATCH OUTPUT MON
Ko		561)LATCH DATA IP
Kp		562)LATCH CLOCK IP
Kq		563)LATCH SET IP
Kr		564)LATCH RESET IP
Ks		565)LATCH HI VALUE
Kt		566)LATCH LO VALUE
Ku		567) R
Kv	Ro	568)FILTER1 OP MON
Kw		569)FILTER1 TC
Kx		570) R
Ky		571) R
Kz		572) R
LA	Ro	573)FILTER2 OP MON
LB		574)FILTER2 TC
LC		575) R
LD		576) R
LE		577) R
LF	Ro	578)COUNTER COUNT
LG		579)COUNTER CLOCK
LH		580)COUNTER RESET
LI		581)COUNTER TARGET
LJ	Ro	582)COUNTER > = TARGET
LK	Ro	583)TMR ELAPSED TIME
LL		584)TIMER RESET
LM		585)TIMER INTERVAL
LN	Ro	586)TMR EXPIRED FLAG
LO		587) R
LP		588) R
LQ		589) R
LR		590) R
LS		591) R
LT		592) R
LU		593) R
LV		594) R
LW		595) R
LX		596) R
LY		597) R
LZ		598) R
La		599) R
Lb		600) R
Lc		601) R
Ld		602) R
Le		603) R
Lf		604) R
Lg		605) R
Lh		606) R
Li		607) R
Lj		608) R

Mn		PARAMETER
Lk		609) R
Li		610) R
Lm		611) R
Ln		612) R
Lo		613) R
Lp		614) R
Lq		615) R
Lr		616) R
Ls		617) R
Lt		618) R
Lu		619) R
Lv		620) R
Lw		621) R
Lx		622) R
Ly		623) R
Lz		624) R
MA		625) R
MB		626) R
MC		627) R
MD		628) R
ME		629) R
MF		630) R
MG		631) R
MH		632) R
MI		633) R
MJ		634) R
MK		635) R
ML		636) R
MM		637) R
MN		638) R
MO		639) R
MP		640) R
MQ		641) R
MR		642) R
MS		643) R
MT		644) R
MU		645) R
MV		646) R
MW		647) R
MX		648) R
MY		649) R
MZ		650) R
Ma		651) R
Mb		652) R
Mc		653) R
Md		654) R
Me		655) R
Mf		656) R
Mg		657) R
Mh		658) R
Mi		659) R
Mj		660) R
Mk		661) R
Ml		662) R
Mm		663) R
Mn		664) R

Mn		PARAMETER
Mo		665) R
Mp		666) R
Mq		667) R
Mr		668) R
Ms		669) R
Mt		670) R
Mu		671) R
Mv		672) R
Mw		673) R
Mx		674) R
My		675) R
Mz		676) R
NA		677)RECIPE PAGE
NB		678)MAX CUR RESPONSE
NC	Ro	679)ID ABCXRxxx MON
ND	Ro	680)Iarm BURDEN OHMS
NE	Ro	681)P.SAVED ONCE MON
NF	Ro	682)DOP1 O/P BIN VAL
NG	Ro	683)DOP2 O/P BIN VAL
NH	Ro	684)DOP3 O/P BIN VAL
NI	Ro	685)DIO1 O/P BIN VAL
NJ	Ro	686)DIO2 O/P BIN VAL
NK	Ro	687)DIO3 O/P BIN VAL
NL	Ro	688)DIO4 O/P BIN VAL
NM	Ro	689)IN JOG FLAG
NN	Ro	690)WEB BREAK FLAG
NO	Ro	691)SUM1 CH2 SUBTOT.
NP	Ro	692)SUM1 CH1 SUBTOT.
NQ	Ro	693)SUM2 CH2 SUBTOT.
NR	Ro	694)SUM2 CH1 SUBTOT.
NS	Ro	695)WEB SPEED RECT.
NT	Ro	696)REEL SPEED RECT.
NU	Ro	697)DIAMETER UNFILT.
NV	Ro	698)HEALTHY FLAG
NW	Ro	699)READY FLAG
NX	Ro	700)STALL WARNING
NY	Ro	701)REF XC WARNING
NZ	Ro	702)THERMISTOR WARN
Na	Ro	703)SPEED FBK WARN
Nb	Ro	704)ILOOP OFF WARN
Nc		705)LP FILTER INPUT
Nd	Ro	706)LP FILTER OUTPUT
Ne	Ro	707)AUTOTUNE MONITOR
Nf		708)REMOTE PARAM RCV
Ng	Ro	709)MOTOR (enc) RPM %
Nh	Ro	710)POSITION COUNT
Ni		711)POS CNT DIVIDER
Nj		712)USER ALARM INPUT
Nk	Ro	713)SPEED LOOP PI OP
Nl	Ro	714)IN SLACK FLAG
Nm	Ro	715)SPD FBK % UNF
Nn	Ro	716)TACHO % UNF
No	Ro	717)MOTOR RPM UNF
Np	Ro	718)CUR DEMAND UNF
Nq	Ro	719)CUR FBK % UNF
Nr	Ro	720)SYSTEM RESET



**Sprint Electric Limited**  
**Arundel, UK**

**Tel.           + 44 (0)1903 730000**  
**Fax.           + 44 (0)1903 730893**  
**Email.        info@sprint-electric.com**

**[www.sprint-electric.com](http://www.sprint-electric.com)**