

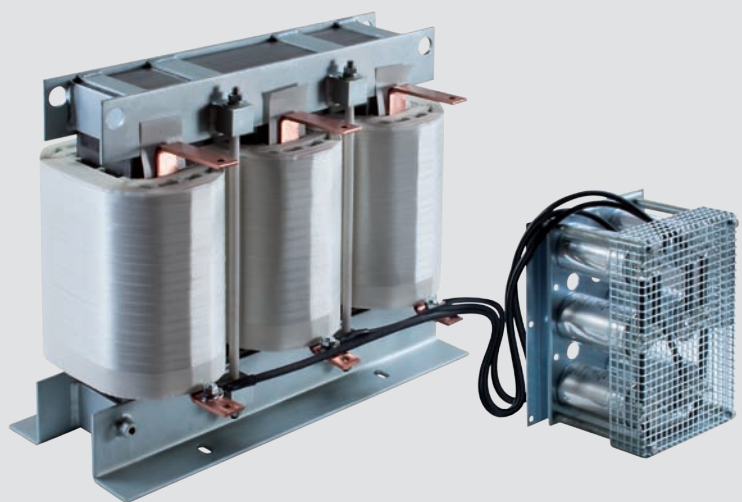

**Application Note**

Sine wave filter solutions for motor drive applications



Note: This document is intended to support designers, installers, and application engineers with sine wave filter selection, installation, application and maintenance in motor drives applications.

In order to get the maximum benefit out of the Schaffner filters, please also consult "Basics in EMC and Power Quality", published in the download section of [www.schaffner.com](http://www.schaffner.com).

These additional guidelines provide helpful hints for HF-grounding, shielding, proper cable routing including a chapter "Output solutions for motor drives".

**Schaffner will not assume liability for any consequential downtimes or damages resulting from use or application of this document and/or installation of Schaffners or any other sine wave filter.**

## Content

<b>1. Technical background</b>	<b>3</b>
<b>2. Motor drives output phenomena</b>	<b>4</b>
2.1 Excessive dv/dt	4
2.2 Peak- and overvoltage	5
2.3 Additional losses in the motor	6
2.4 Cable shields and parasitic earth currents	6
2.5 HF electromagnetic noise in the motor cable	7
2.6 Bearing currents	8
2.7 Acoustic motor noise	9
<b>3. Output filter solutions for motor drives</b>	<b>10</b>
3.1 dv/dt reactor	10
3.2 dv/dt filter	11
3.3 Sine wave filter	12
3.3.1 Symmetrical sine wave filter	13
3.3.2 Sinus plus symmetrical and asymmetrical sine wave filter	14
<b>4. Sine wave filter selection</b>	<b>16</b>
4.1 Current and voltage rating	16
4.2 Frequency	17
4.3 Required drives settings	18
4.4 Voltage drop considerations	20
<b>5. Application examples</b>	<b>21</b>
5.1 Motor drive with long motor cable	21
5.2 Motor drive with multiple motors in parallel	21
5.3 Retrofit installations with motor drives	21
5.4 LV motor drive with MV-motor/ step-down/step-up transformer application	22
<b>6. Mounting and installation guidelines</b>	<b>22</b>
6.1 Important safety considerations	22
6.2 General application notes	23
6.3 General installation notes	24
6.4 Mechanical mounting	25
6.5 Wiring and cabling	25

# 1. Technical background

Whenever electricity is used to drive an equipment, in particular when a motor drive is controlling the speed of an electric motor special attention of the noises generated by the motor drives need to be taken into considerations along the entire electric power line from the source to the load.

This guideline is intended to describe why and when to use which type of motor drive output filter. Nevertheless, following overall view of the noise potential around the motor drive, which can cause equipment to malfunction or be damaged, is shown as follow:

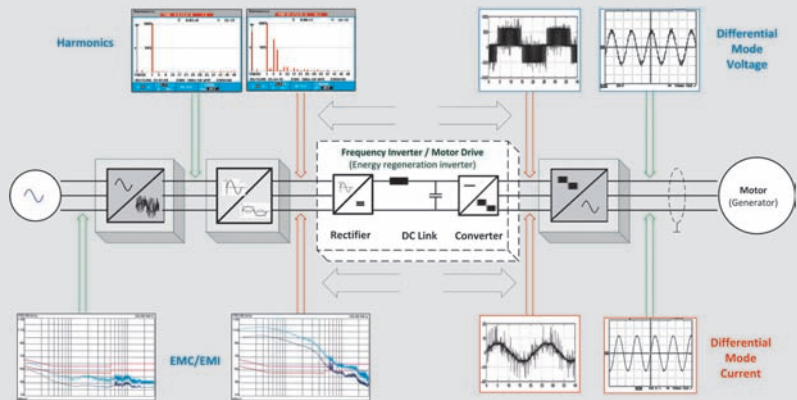

Overview of noise potential around a motor drive

For cancellation of the unwanted noises and fulfilment of the norms on the line side, Schaffner offers a complete range of EMC filter- and harmonic filter solutions for any applications, enabling cost effective standard and customized solutions to cancel or reduce the voltage and current noises to the levels required.

For 3-Phase motor drive applications, following filter combinations are appropriate to be considered:

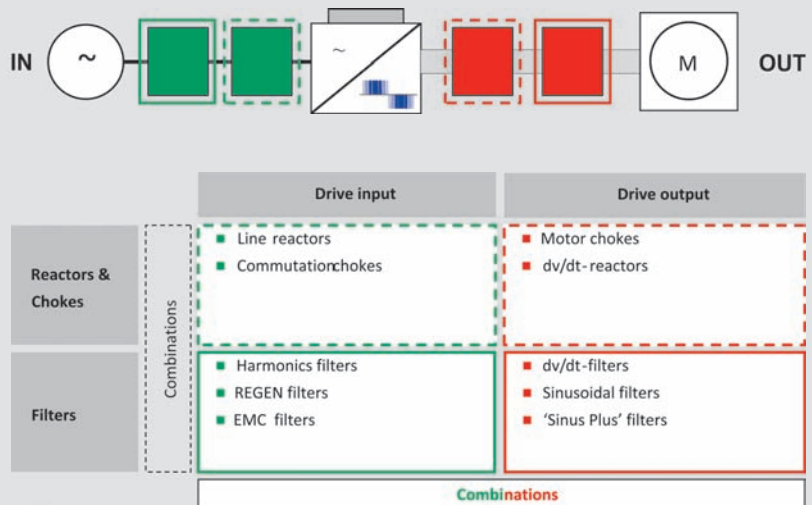

In this application and selection guide the output filters and in particular the sine wave filters will be described in detail.

Motor drives (frequency inverters) are among the most widely used pieces of equipment for AC motor control. Nowadays, they are found in virtually every area of industry, in applications as diverse as pumps, air conditioning systems, elevators and cranes, conveyors, machine tools, renewable electricity production and in a vast array of other industrial and domestic automation. In the quest for ultra-compact, efficient power conversion, motor drive manufacturers employ high-speed semiconductor (IGBT) switches and pulse width modulation (PWM) techniques to generate fast rise time voltage pulses of the appropriate duration and polarity. Unfortunately, this creates a considerable number of problems for OEMs and system integrators, from purely functional difficulties to very severe motor damage. Here is a brief summary of the most significant problems and phenomena:

**Motor drive input:**

- | EMC problems
- | Harmonics
- | Commutation notches
- | Inrush & peak currents
- | Low-frequency interference

**Motor drive DC link:**

- | DC link capacitor stress
- | Harmonics
- | Other interference problems

**Motor drive output:**

- | Excessive dv/dt
- | Peak- and overvoltage
- | Parasitic earth currents
- | Eddy current losses in the motor
- | Displacement currents in the coils
- | Bearing currents
- | Additional inverter pulse loads
- | Acoustic motor noise
- | EMC problems

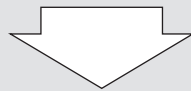

**Whole system:**

- | Low efficiency/low power factor
- | Uncertain system immunity
- | Unacceptable interference emissions
- | Uncertain service security & reliability

## 2. Motor drives output phenomena/influence

Motor drives are known sources of interference and are therefore usually equipped with an input filter. However, the problems generated on the output side of the motor drives where the converter supplies the motor with a modulated rectangular PWM signal (a switching frequency dependent series of trapezoidal pulses with variable width) have to be taken into additional consideration as described in following chapters.

### 2.1 Excessive dv/dt voltage

To keep the losses in the frequency converter low, the aim is to keep the switching times of the power semiconductors as short as possible. The result of this is that with the newest generation of IGBTs, rise times of sometimes more than 12 kV/us can be measured, whereas – depending on the motor – a dv/dt of around 1000 V/us is considered permissible. The IEC 60034-17 standard does define the voltage peak limits in relation to the rise



time for general purpose 500 VAC motors when fed by motor drives and IEC 60034-25 specifies the limits for motor drive rated 500 VAC and 690 VAC motors. For US applications the NEMA MG1 standard shows the limit for definite purpose motor drive fed motors.

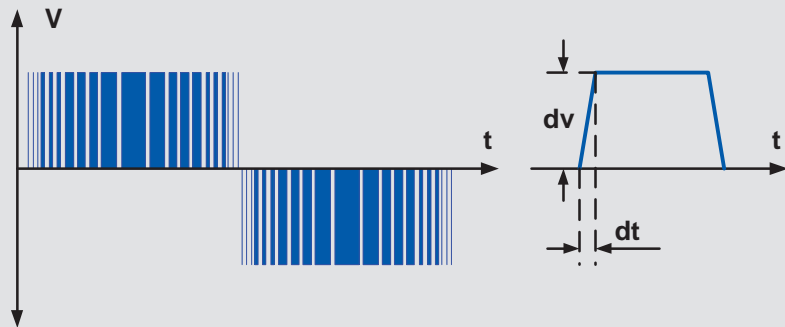

Definition of  $dv/dt$ : PWM-Signal and single pulse at the inverter output

In the case of short motor cables (up to about 20 m), these rise times – owing to the small line impedance – act fully on the insulation of the motor windings. Depending on the structure of the motor coils, wires that carry the full voltage are situated immediately in parallel and next to each other. Since even very short parallel-laid wires have a capacitive action, the permanent potential jumps result in pole reversal losses across the winding insulation. Now, if the enamel insulation is impure even to a very minor extent, this results in hot-spots, and hence, sooner or later, to a destruction of the winding insulation. In any case, this  $dv/dt$  stress leads to premature aging and thus to a reduction in the life of the motor, in particular when an older motor is fed by a motor drive.

## 2.2 Peak- and overvoltage

Voltage overshoots and voltage peaks can come with high  $dv/dt$  values but are also a problem on their own. Due to the structure of the windings, a motor acts like a capacitor in the equivalent circuit diagram – owing to the fast voltage pulses of the switching frequency – and not as an inductance, as is the case in normal 50 Hz applications. With every additional meter of motor cable, more wire inductance is added to this structure. This inductance acts like a choke according to the energy storage principle. If chokes are subject to voltage pulses, voltage peaks occur every time switching on or off takes place. The higher the energy content (inductance) of the choke, the higher these voltage peaks become. In other words, the longer the motor cable, the higher the maximum voltage amplitudes.

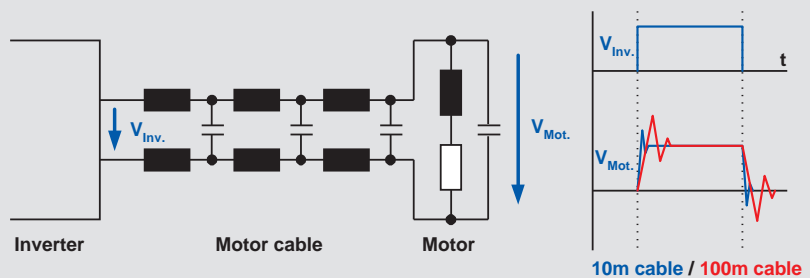

Simplified equivalent circuit diagram of shielded cables (only 2 phases are shown) and theoretical single pulse at 10 m and at 100 m motor cable length

These amplitudes can, in turn, reach values that cause a stress situation in the winding insulation of the connected motor. Owing to the cable impedance, the  $dv/dt$  stress – in the case of longer motor cables – is reduced to less problematical values. On the basis of the line theory, however, peak values of 1600 V or more (depending on the DC link voltage) can occur due to cable reflections, which can have very steep  $dv/dt$  values. According to IEC 60034, peak values of around 1000 V are recommended. In cases the resulting voltage peak and rise time exceed the standard limits an output filter should be used for protecting the motor winding insulation. Despite the reduced  $dv/dt$  owing to the cable impedance, there is no significant stress relief for the motor, since now the increased voltage amplitudes represent the dominant stress factor.

### **2.3 Additional losses in the motor**

Apart from protecting the winding insulation against unacceptable voltage peaks, the steep switching edges create another phenomenon of harmonics of the output signal. By applying Fourier analysis, it can be mathematically proven that the harmonic spectrum of the motor currents becomes wider with the steepness of the pulses which means that the harmonic content increases. The current ripple (PWM and harmonics) results in additional magnetic losses in the motor. The life of the motor is sensitively shortened owing to the permanently increased operating temperature.

### **2.4 Cable shields and parasitic earth currents**

From the standpoint of EMI suppression, shielded motor cables are required to avoid back-coupling of radiated interference to the mains cable in the frequency range from about 1 to 30 MHz. This measure of the EMC can, however, only be considered to be efficient if the ends of the cable shield of the motor cable are put in contact with the ground of the motor and the frequency converter – if possible, at HF low impedance and over as large an area as possible. This ensures that the interference currents can mostly flow back to the source by the shortest route. Frequency converters normally work in grounded networks and do not have any potential separation. The geometric expansion of the frequency converter, motor and this shielded motor cable therefore form parasitic capacitances of the electrically conducting components with respect to the ground potential. If the available DC voltage is chopped in the frequency converter, then during the potential jumps of the voltage, considerable pulse currents flow across the parasitic capacitances to the earth. The level of the interference currents on the cable shield depends on the  $dv/dt$  as well as the value of the parasitic capacitances ( $I = C * dv/dt$ ). With a motor cable length of about 100 m, peak values of the pulse currents of 20 amperes and more are not unusual, regardless of the power rating class of the drive.

The harmonic spectrum of these currents can reach a range of several MHz. The shield of the motor cable, owing to the existing braiding, offers a very large surface area and a sufficient cross-section to carry these currents. As a result, the impedance of the shield across a broad frequency range is of a very low-impedance nature. Losses due to the skin effect are limited to a minimum because of the large surface area. Inadequate ground connections of the cable shield (the so-called “pigtailed”), on the other hand, are highly resistive for the frequency range under consideration and often nullify the desired shielding effect.

If there are parallel-laid control cables or electronic components in the vicinity of the motor cables, pulsed HF currents flow across their geometric expansion and the resultant parasitic capacitances, which in turn could have an impermissible influence on neighbouring equipment through capacitive coupling.

If neighbouring components are located in the immediate vicinity of the motor cable, the conductor loops and the high  $di/dt$  values of the shield currents also result in a magnetic coupling that can also lead to impermissible influencing.

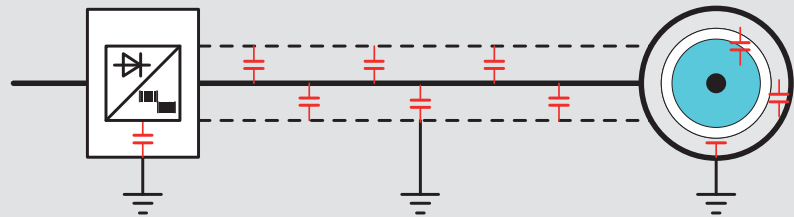

*Parasitic capacitances in a drive system*

The currents flowing across the shield must be supplied by the frequency converter as well. They are not dependent on the rating of the drive but only on the geometric expansion of the structure. With small power ratings, the result of this, especially in case of long motor cables, can be that a frequency converter of the next higher rating has to be used that is able to supply both the currents required by the load and the parasitic currents via the earthing. The operation of several motors connected in parallel on one frequency converter is problematic. The parallel connection of several shielded cables results in a relatively high total capacitance and thus correspondingly high shield currents. The parallel connection of several drives, however, is accompanied by even more issues to be solved. Parasitic currents across the motor and the installation can considerably affect the reliability of the entire system.

**>>>** refer also application examples in chapter 5

### **2.5 HF electromagnetic noise in the motor cable**

The high frequency noise is caused by the switching frequency of the semiconductors. The source occurs due to the pulse voltage overshoot at the motor terminal. With the use of a  $dv/dt$  filter the frequency of the ringing oscillation is only reduced below 150 kHz compared with a sine wave filter eliminating the pulse voltage overshoot completely by feeding the motor with a sine wave phase-to-phase voltage.

The noise coupling between the unshielded motor cable with the line cable or other sensitive cables (sensors, encoder etc.) can be reduced when using sine wave filters in combination with EMC line filters.

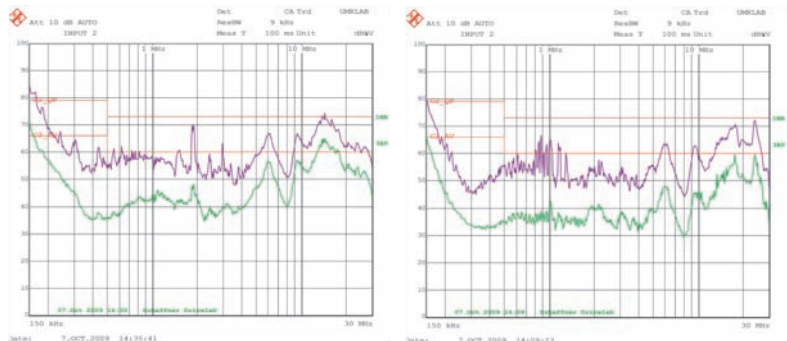

Line conducted noise without (left) and with sine wave filter (right)

## 2.6 Bearing currents

A general distinction has to be made between two different physical occurrences:

- The shaft voltage (or rotor voltage) is an inductive voltage that is induced in the motor shaft owing to the differences in the flux densities of the stator and rotor. Above all, it is influenced by the length of the motor. As long as the lubricant film in the bearing is intact, the voltage builds up until, finally, a compensating current flows towards the earth. In this case, the path of least resistance is through the motor bearings. This bearing current ( $I_1$ ), over a long period of time, usually results in drying out the bearings and thus create a mechanical motor failure, acoustic noise and a possible break-down. It is possible to counter this phenomenon to a certain degree through the use of ceramic bearings.
- The bearing voltage is an asymmetric (common-mode) voltage that occurs because of capacitive coupling between the motor housing, the stator and the rotor (C 1, C 2, C 3) and results in  $dv/dt$  and electrostatic discharge currents ( $I_{dv/dt}$  and  $I_{EDM}$ ) across the bearing (C Bearing, U Bearing). To be more accurate, this bearing voltage results in two different currents: in the first minutes of operation, as long as the lubricant in the bearing is cold, currents in the range of 5 to 200 mA ( $I_{dv/dt}$ ) flow through C Bearing because of the  $dv/dt$ . These rather negligible currents generally do not result in any bearing damage. After a little while, when the lubricant film has heated up, peak currents of 5 to 10 A and more can be measured ( $I_{EDM}$ ). These flashovers leave behind small pits on the surface of the bearing. The running of the bearing becomes increasingly rough because of the damaged surface and the life is thus considerably shortened. Typically, the bearing voltage is between 10 and 30 V. But since it is directly dependent on the mains supply voltage, bearing damage increases over proportionally at higher supply voltages.

In the case of the use of unshielded motor cables, the cable capacitance (C Cable) and hence the current ( $I_{Cable}$ ) is relatively small. The parasitic capacitances on the inside of the motor dominate. Ideally, the parasitic currents flow through the motor housing to the ground ( $I_{C1}$ ).



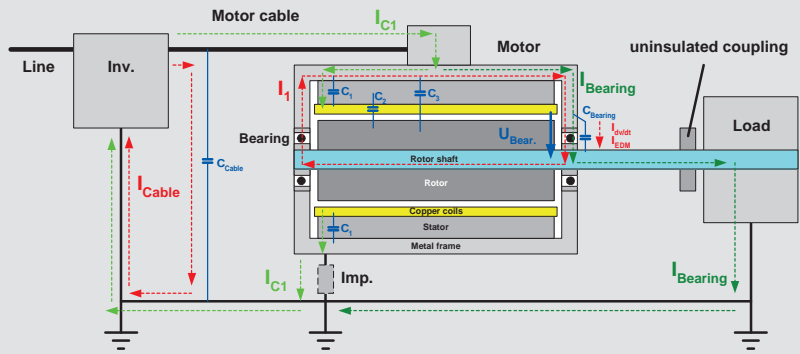

However, if the grounding of the motor is inadequate, an additional impedance (Imp.) is limiting the current ( $I_{C1}$ ). As a result of the additional impedance, the potentials at C 2, C 3 and C Bearing increase sharply. The values of the bearing currents also increase massively and flow fully through the bearings to the earth ( $I_{Bearing}$ ); in that case, the life expectancy of the ball bearings, and hence of the entire motor, is reduced to a few hours.

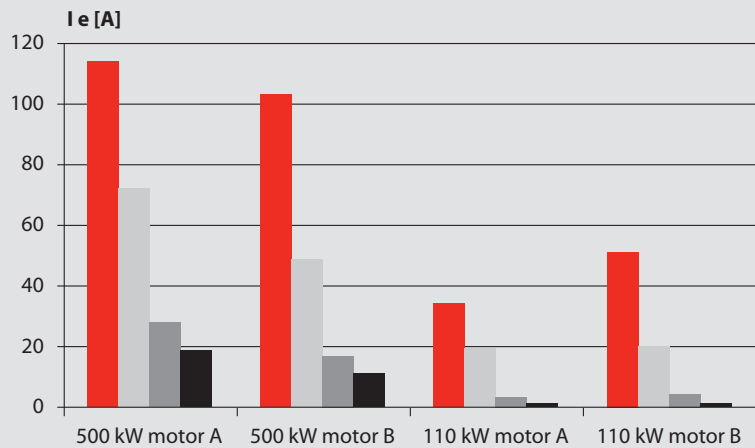

- motor earth current with out filter
- motor earth current with sine wave filter
- motor bearing current with out filter
- motor bearing current with sine wave filter

## 2.7 Acoustic motor noise

Compared to the previously described issues, the whistling noises of the motor – caused by the pulse width modulated (PWM) switching frequency – would appear to be negligible. However, in applications related to heating, ventilation and airconditioning technology (HVAC), the noise is distributed and may be amplified in the entire building through air ducts or heating pipes. For acoustic noise sensitive applications, often the motor drive switching frequency is set to 16 kHz, since this audible frequency noise level is less noticeable by humans. This generates higher IGBT switching losses, higher heating, higher leakage currents and therefore a corresponding derating of the motor drive need to be taken into consideration.

Three main acoustic noise sources are generated by motors:

- Motor core magnetic noise, through magnetostriction
- Motor bearing noise
- Motor ventilation noise

In order to eliminate or reduce unwanted acoustic noise levels, a sine-wave filter can be used. This will filter the pulse shaped voltage from the frequency converter and provide a smooth sinusoidal phase-to-phase voltage at the motor terminals.

### 3. Output filter solutions for motor drives

For reasons of cost, time and space, an attempt is generally first made to overcome the motor drives issues without additional components. However, the subsequent costs that can result from motor or system failures are often entirely out of proportion to the far lower initial costs of preventive output filter measures. If the decision is made in favour of components to increase the reliability, the operational safety and the installation lifetime the following types of passive output filter components have established themselves to solve the major application requirements:

- dv/dt reactors (increase inductivity, signal smoothing)
- dv/dt filters (low inductance, hardly any reduction in the control dynamic)
- Sinusoidal output filters (high L and C for optimizing the output signal, but also not universally applicable)

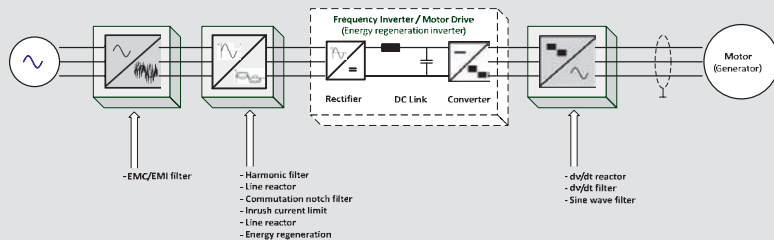

Locations of filters around motor / power drives

#### 3.1 dv/dt reactor

Reactors can be used in various locations in a power drive system: as line reactor, in the DC link between the rectifier and capacitor (DC link choke) and at the drive output to the motor (dv/dt reactor). A reactor at each of these positions has specific effects that are by no means mutually exclusive.

Generally, it would be unnecessary to have a reactor in both the power input and the DC link, but the functions of the input line reactor are quite different from a filter at the drive output, and it is entirely reasonable to include both of these.

A reactor on the line side will do two things: protect the drive electronics from power disturbances and protect the power supply from disturbances created by the drive. In this document the line input side will not be covered in depth, therefore please consult for more information the "Basics in EMC and Power Quality", published in the download section of [www.schaffner.com](http://www.schaffner.com)

With Schaffner dv/dt reactor types RWK305 a cost efficient reduction of high output voltage dv/dt from IGBT motor drives can be achieved. The voltage still being PWM pulse pattern shaped generates a lower output current ripple.

It protects the motor coil insulation from premature aging and destruction and increases significantly the service life of electric motors. dv/dt reactors are limited when used with long motor cables. The maximum admissible motor cable length depends mainly on the switching frequency and the drive output voltage. The value for a given application can be found in the derating curve below.

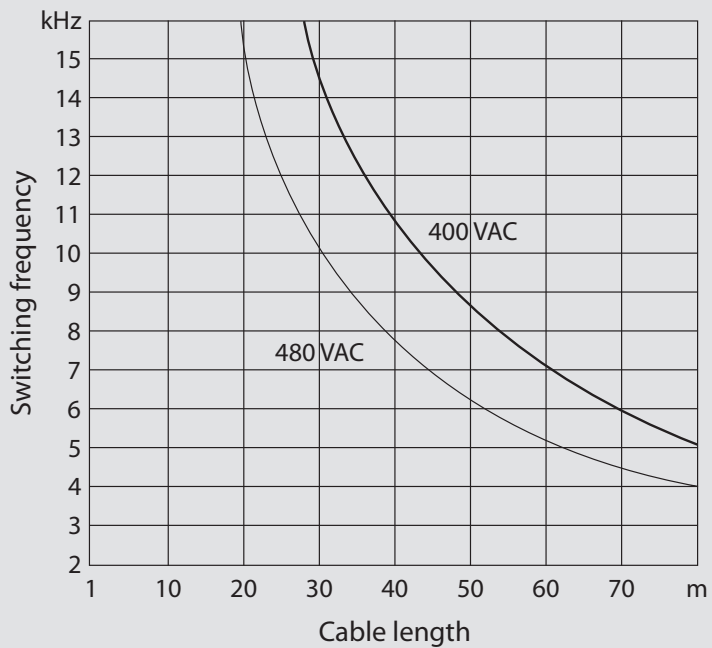

Switching frequency depending cable length curves for RWK305 reactor

### 3.2 dv/dt filter

Motor drives switching frequencies of 16 kHz or more can generate dv/dt values of up to 12 kV/us. Depending on the output voltage of the motor drive, the cable length and type as well as the layout do influence the voltage rise time. High dv/dt levels can damage the motor windings. According to EN 60034 voltage rise times of 500 to 1000 V/us are permissible depending on motor types.

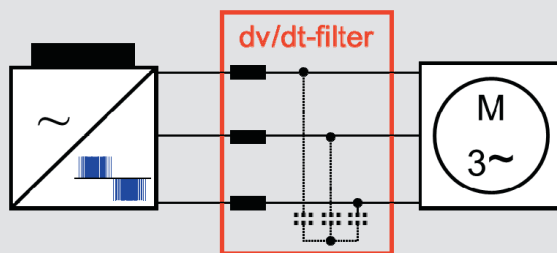

The dv/dt filters are low pass filter built with inductors, capacitors and power resistors. The nominal switching frequency of the motor drive shall be below the typical cut off frequency of the dv/dt filter (typical < 10 kHz). The sine wave filter have higher L and C values, therefore dv/dt filters are lower in cost and smaller in size. With a dv/dt filter the output current ripple is lower but the voltage is still PWM pulse pattern shaped.

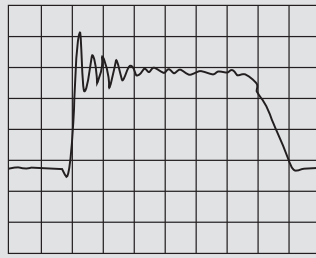

Without dv/dt filter

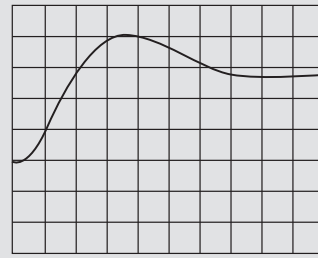

With dv/dt filter

The Filter FN510 from Schaffner reduces the high output voltage  $dv/dt$  from IGBT motor drives and limits the peak voltage to 1000 V. It protects the motor insulation windings from premature aging and destruction and increases significantly the service life of electric motors. In addition less interference propagation towards neighbouring equipment or lines are occurring. The typical cable length used is  $\leq 80$  m at a maximum switching frequency of 16 kHz at 400 VAC.

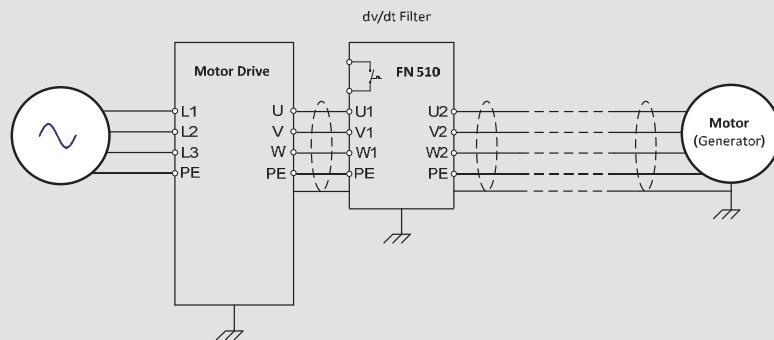

Side effect of the use of a  $dv/dt$  filter: the frequency of the pulse ringing voltage oscillation is reduced below 150 kHz. Mainly for high power motors, the motor bearing stress is slightly reduced, but  $dv/dt$  filters do not eliminate the acoustic switching frequency noise from the motor.

### 3.3 Sine wave filter

Sine wave filters are low pass frequency filters which convert the rectangular PWM output signal of motor drives into a smooth sine wave voltage with low residual ripple. Sine wave filters, also known as LC-filters or named sinusoidal filters, are mainly used in combination with variable speed drives to protect the motor against excessive voltage spikes and overheating. As a result, insulation stress and losses in AC motors are reduced and prolongate the motor life time.

Voltages: *drive output w/o filter*      *sine wave filter output*

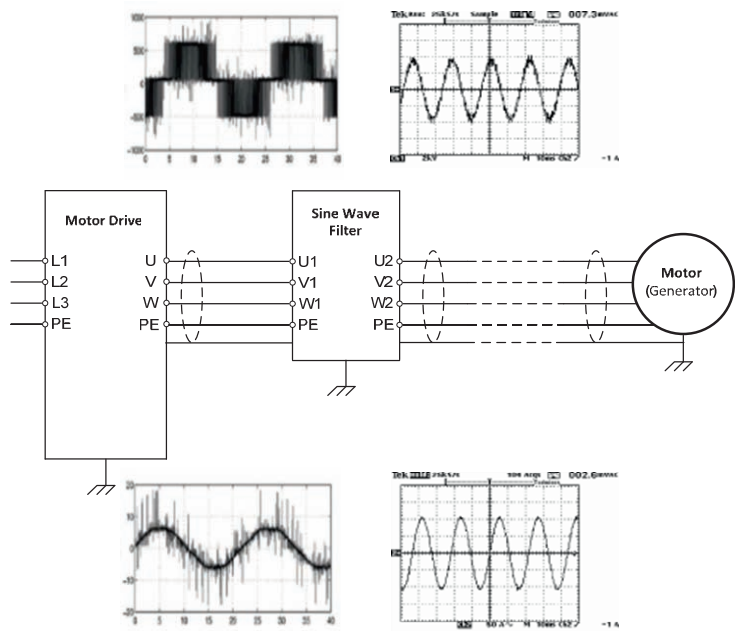

Currents: *drive output w/o filter*      *sine wave filter output*

### 3.3.1 Differential mode sine wave filter

There are basically two types of sine wave filters. For the majority of the applications, the basic versions are the differential mode (also called symmetric) sine wave filter types FN5020, FN5040, FN5040HV and FN5045 from Schaffner.

Differential mode sine wave output filters connected directly to the motor drive output have, above all, the following advantages:

- Protect motor winding insulation against  $dv/dt$  voltage spikes and overvoltage
- Reduction of the additional magnetic losses and eddy current losses in the motor
- Reduction of motor heating
- Reduction of the additional losses of the motor drives
- Reduction of motor bearing currents caused by circulating currents
- Reduction of the acoustic noise of the motor
- Reduction of electromagnetic emissions of motor cables

For following applications differential mode sine wave filters are strongly recommended:

- Applications with motor cable runs above 100 m long
- Applications with 600 VAC/60 Hz or 690 VAC/50 Hz motors, even with short motor cables
- Motor drive applications with multiple motors in parallel
- LV motor drive feeding MV motor through step-up transformer
- Increase in the reliability and operational safety of the overall system



For a large number of applications, differential mode sine wave filters can be considered to be the ideal solution. The major motor drives issues are solved efficiently and in a cost-effective way.

Schaffner's sine wave filter are matching the technical requirements of modern drive systems and are particularly used for long motor cable applications. In addition they calm down acoustic motor noises, lower the HF-leakage currents, reduce bearing currents and eliminate the pulse reflections in the motor cable thus reducing the motor drive losses. Finally they are very useful for special AC motor drive applications requiring a smooth sine wave voltage.

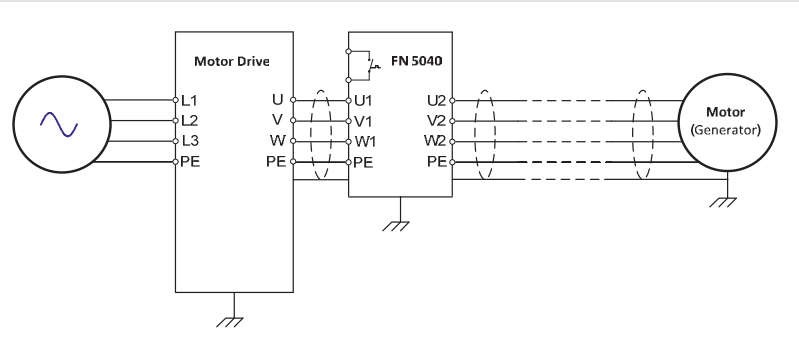

*Motor drive with differential mode sine wave filter*

The residual ripple of the signal can be adjusted by using the values of the L and C. An optimum cost-benefit ratio is often reached at a ripple voltage of 3% to 5%.

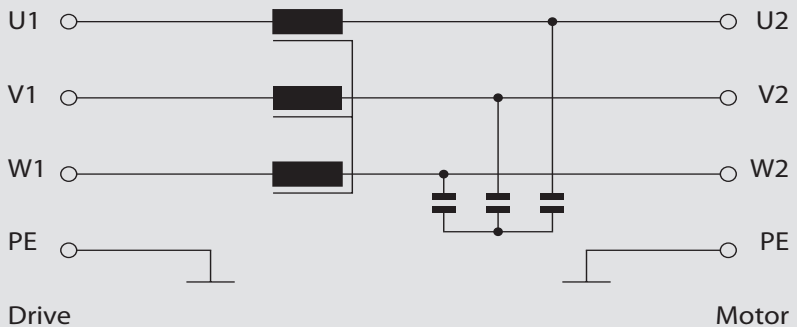

*Differential mode LC sine wave filter*

### 3.3.2 Sinus plus (differential and common mode) sine wave filter

In some cases, additional measures with motor drives applications are necessary. To counter effects or requirements such as

- Bearing damage caused by common mode currents (shaft currents)
- Parasitic earth currents
- Avoid shielded motor cables (e.g. for retrofit installations)
- Motors not having conform motor drives insulation prerequisite (e.g. for retrofit installations)
- Limited maximum possible motor cable length

Sinus plus is a highly developed modular sine wave filter concept from Schaffner that is unique in the market today. Consisting of a traditional differential (symmetric) and an additional common mode (asymmetric) sine wave filter module, it can be customized exactly to any requirement. Through innovative circuits and an additional connection to the DC link, the additional module is capable of sending the common mode interferences directly to the very place they originated.

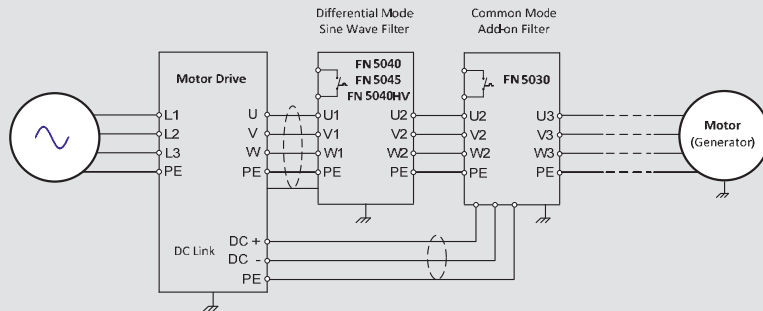

*Drive with differential mode and add-on common mode filter modules*

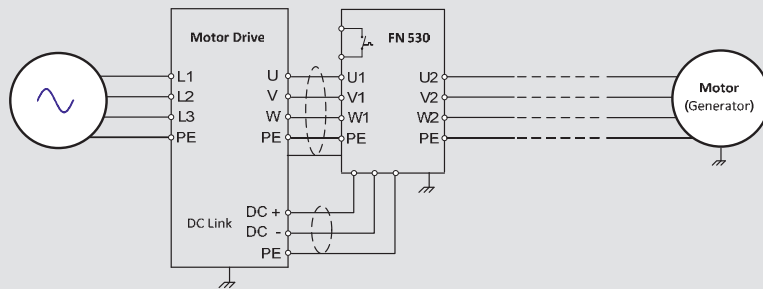

*Drive with differential- and common mode all-in-one sine wave filter*

This procedure is in keeping with the basic principle of interference suppression techniques: take the necessary measures at the source of the noise, not at the drain. Sinus Plus can be considered as a modular system in which the differential filter part (FN5020, FN5040 and FN5045) can be connected autonomously and the common mode part (FN5030) may be added or as an all-in-one type sine wave filter (FN530).

### Shielding

Shielding of certain conductors is necessary to prevent interference energy radiation into the environment.

- Cable must be shielded between the inverter output and filter input (U, V, W), connect the cable present directly to the inverter
- Motor cable between the filter output (U1, V1, W1) and the motor itself does not have to be screened (unless special installation requirements apply)
- The shield must be solidly connected at both ends to the housings (e.g. housing of filter and motor)
- All shield connections must exhibit the largest possible impedance, i.e. solid, large area connections

### Feedback to the dc link

If only one connection to the dc link is brought out of the inverter (“+” or “-”) then the dc link cable connections from the filter (identified by “DC+” and “DC-”) must be connected together to the “+” or “-” inverter connection. A lower switching frequency or a pure block modulation is unsuitable and results in the inverter being switched off with the error message “overcurrent” or “earth connection”.

FN530 combines both solutions in one box. Operated in combination, this solution results in the following additional advantages:

- Complete elimination of bearing damage
- The possibility of using unshielded motor cables without any reductions in immunity
- Practically no more limitations with regard to the maximum cable length
- Almost complete elimination of the pulse currents to earth
- No interference influence of neighbouring cables and equipment
- Elimination of the additional losses in the frequency converter
- Reduction in the suppression efforts on the input side. Since frequency converters are operated in ground-referred networks, every measure taken on the output side also influences the behaviour on the input side (and vice versa). Since hardly any pulsed interference currents flow to the earth when Sinus Plus is used, the asymmetric part of the EMC mains input filter can be reduced, resulting in total cost savings.

*For further technical specification and information please consult the data-sheets of the corresponding products published in the download section of [www.schaffner.com](http://www.schaffner.com)*

## 4. Sine wave filter selection

### 4.1 Current and voltage rating

Schaffner’s standard sine wave filters are designed to be applied with most commonly used standard motor drives and motors available on the global market. For dedicated and special requirements Schaffner does design customized sine wave filters adapted to the specific needs.

In principle the nominal motor current and the duty cycle is defining the size of the output filter. Schaffner filters are rated for 150% overload for 1 minute, ones per hour. Above 150% rated current the saturation of the inductance can be reached and destroy the capacitors.

It is recommended that the rated current of the sine wave filter shall be equal to or greater than the nominal motor current and should correspond and be compatible with the ratings and duty cycle capability of the motor drive.

For motor drives feeding isolation transformers select a sine wave filter with a current rating equal or greater than that of the transformer primary current.

With regard to the voltage, Schaffner offers sine wave filter for 400 VAC, 500 VAC, 600 VAC and 690 VAC applications. Even for short cable installations, at voltages > 500 VAC sine wave filter are recommended, to protect the motor winding insulation against high voltage peaks.

In cases the motor drive selection has been made prior to the sine wave filter selection, the usual way is to size the sine wave filter to the corresponding motor drive. Nevertheless, the proper power selection depends on one side upon the drives related specifications, e.g. rated current, voltage, line frequency, motor drives switching frequency, motor frequency, the ambient conditions (temperature, altitude) and on the other side on the motor and application performance requirements. In addition the motor cable length, cable type, motor type, and some particular application requirements needs to be considered.

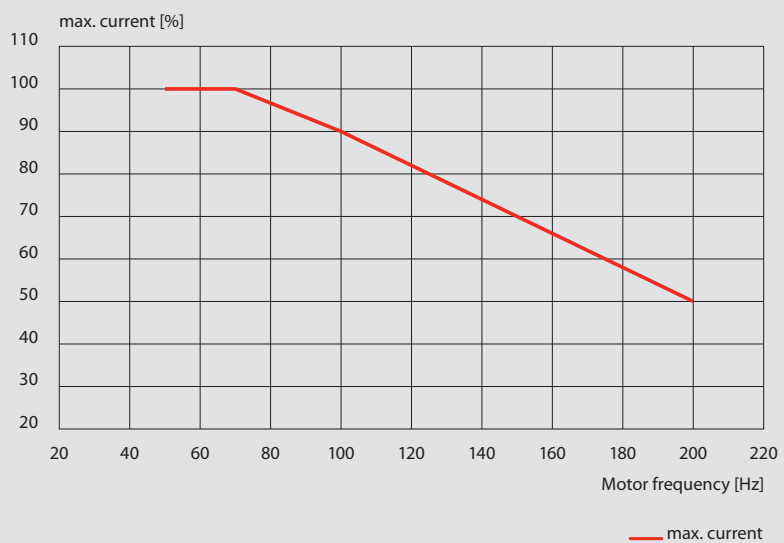

*Derating curve: maximum current vs. motor frequency for FN5040*

#### 4.2 Frequency

The frequency is an important factor when selecting output filter. Depending on the type of filter, three different frequencies are relevant.

- | Supply frequency. The frequency of the AC mains supply network, typically 50 or 60 Hz. The operating frequency of the filter is determined by the behaviour of the capacitors. Depending on the voltage/frequency characteristic of the capacitor, it might be possible to operate a filter at a higher frequency but with a reduced input voltage.
- | Switching frequency. The frequency used to switch the IGBTs in the output stage of a frequency converter. This frequency has a direct relation to the power loss in the converter and to the output components.

Higher switching frequencies have following effects:

- increasing the switching losses of the semiconductors
  - > temperature rise of motor drive -> derating to be considered
- reducing the audible noise level
- increasing the leakage currents
- reducing the harmonic motor current and motor temperature

Generally speaking, lower frequencies result in lower motor drive losses and lower leakage currents.

For an output filter, it is also necessary to consider the relation between the motor drive switching frequency and the resonance frequency of the sine wave filter. The Schaffner sine wave filters are always designed in such a way that the resonance frequency is at least 2.5 times lower than the lowest switching frequency. It is important that the minimum switching frequency adjusted in the motor drive is respected according to the specified minimum switching frequency of the sine wave filter (refer the product datasheet).

**I Motor frequency.** The simulated supply frequency of the frequency converter. This frequency determines the rotational speed of the motor. Most applications operate at 50/60 Hz motor fields, but applications with higher rotational speeds also exist (high-speed spindle drives up to 2000 Hz).

Sine wave filters usually have a better performance compared to dv/dt chokes or dv/dt filters. The resonance frequency of the sine wave filter must be at least 2.5–3 times lower than the motor drive switching frequency.

#### 4.3 Required drives settings

The nominal switching frequency of the motor drive can vary or be adjusted and therefore need to be considered from the beginning for the sine wave filter selection.

The motor drive must be suitable to be operated with sine wave filter and therefore shall be adjusted with a constant switching frequency. The mode of operation must be “scalar” (V/Hz) with a fixed switching frequency. Check the drives manufacturer manual whether special settings are necessary. In any doubt contact the drives manufacturer.

Ensure the drives switching frequency is set to the required minimum switching frequency (refer filter selection table of corresponding product datasheet).

Following are the product specific rating selection guidelines with regard to the maximum permissible cable length in relation with the minimum PWM switching frequency:

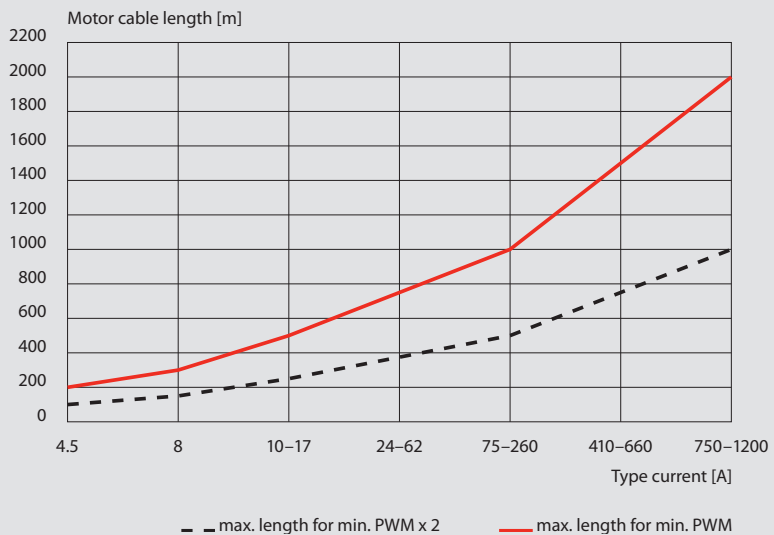

Selection curve for 500 VAC sine wave filter FN5040 and FN5045 series



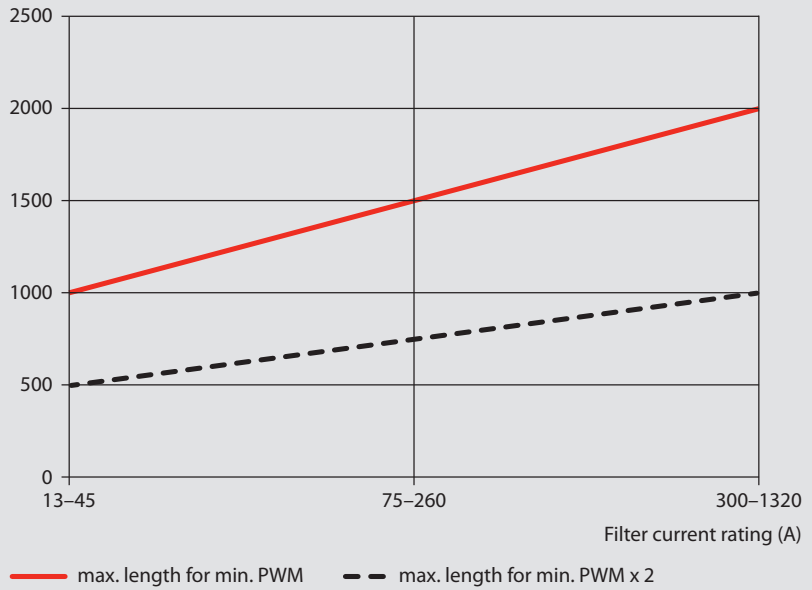

Selection curve for 690 VAC sine wave filter FN5040 HV series

\*In case a step-up transformer is used, then the length is meant to be between the filter and transformer.

Sine wave filters, unlike  $dV/dt$  filters, can be applied for higher switching frequencies (some types up to 16 kHz) than the nominal switching frequency, but lower switching frequencies close to the resonance frequency of the sine wave filter will damage the capacitors. Ensure that the switching frequency of the motor drive is always higher than the minimum allowed switching frequency as shown in following table.

Schaffner's sine wave filters support lower minimum switching frequencies, therefore a derating of the motor drive is not necessary and does reduce the overall system cost. The minimum switching frequency is compatible with typical motor drives on the market. With reduced motor cable length max. switching frequency up to 16 kHz are allowed.

Filter Version Voltage Version & Current Range	Typical motor power	Minimum switching frequency $f_{PWM}$
400 V/4.5 to 48 A	1.1 to 22 kW	4 kHz
400 V/62 to 480 A	30 to 250 kW	3 kHz
400 V/660 to 1200 A	315 to 630 kW	2 kHz
690 V/13 to 300 A	7.5 to 2560 kW	2 kHz
690 V/430 to 1320 A	355 to 1200 kW	1.5 kHz

Following special motor drive considerations need to be taken into account in combination with sine wave filters:

- | Motor drives operating at reduced switching frequency or using block pulsing at particular operation points (e.g. at low motor speed or high load conditions) must not be used or the feature be disabled
- | Sine wave output filter may not be used with servo drives, because they normally are current controlled devices
- | Check the recommended motor drive output frequency levels and adjustments when non-regenerative/regenerative drives with or without brake choppers are used
- | Automatic frequency adaptation modes need to be disabled within the motor drive
- | Protective functions and features of the motor drive, such as overcurrent, short circuit, motor phase loss or imbalance may be impaired in combination with sine wave filter and/or long motor cables

**CAUTION:** If the motor drives settings are not correct the filter may be damaged.

#### 4.4 Voltage drop considerations

The voltage drop across the sine wave filter must be taken into account when dimensioning the motor and the drive.

At constant motor power level the current will increase above the rated current. For constant operation at this level, which means above the field weakening point or at high overload conditions are limiting or reducing the motor torque performance. It is recommended to consider the voltage drop impact when dimensioning the motor and the motor drive.

The voltage drop at full load can not be neglected and therefore the motor will not receive the full voltage at nominal speed.

The additional voltage drop of long motor cables does also influence the selection and dimensioning of the motor and the drive.

Schaffner's sine wave filters have an impedance of 8-10% at nominal voltage, frequency and rated current. They are designed for motor frequency operation up to 70 Hz (up to 200 Hz with derating according graph on page 17).

Voltage drops need to be considered when the motor drives protective functions, such as overcurrent, short circuit, motor phase imbalance, motor phase loss or predictive monitoring features need to be set accordingly. Please refer to the corresponding motor drive manual or application guide.

Due to the charging action of the sine wave filter capacitors through DC currents coming from the motor drive (DC braking, DC injection for motor parameter/characteristics measurements) a short circuit trip within the motor drive could be provoked or the measurement values could be impaired. For those cases some parameters within the motor drive need to be programmed and set accordingly. Contact your motor drives manual or supplier.

## 5. Application examples

Typical applications requiring sine wave filters:

- | Motor drive with long motor cable
- | Motor drive with multiple motors in parallel
- | Retrofit installations with motor drives
- | Step-up transformer applications for LV-drives control of MV-motors

### 5.1 Motor drive with long motor cable

For motor drives controlling a motor over a long distance with a shielded motor cable can lead to the effect of high parasitic capacitive currents flowing across the shield. Those unwanted currents must as well be supplied by the frequency converter or motor drive. The result of this can be that a motor drive of the next higher rating has to be used that is able to supply both the currents required by the load and the parasitic currents via the earthing.

When using a sine wave filter the maximum motor cable length does depend on the motor drive switching frequency.

>>> refer to chapter 4.3 Required drive settings

### 5.2 Motor drive with multiple motors in parallel

The operation of several motors connected in parallel to one frequency converter is problematic. The parallel connection of several shielded cables results in a relatively high total capacitance and thus correspondingly high shield currents. The parallel connection of several drives, however, is accompanied by even more problems. Parasitic currents across the motor and the entire system can considerably affect the reliability of the whole system.

For such configurations it is recommended to use a sine wave filter covering the symmetrical and asymmetrical aspects as described in chapter 3.3.2 Sinus Plus symmetrical and asymmetrical sine wave output filter.

### 5.3 Retrofit installations with motor drives

For existing installation where long motor cables and old motors want to be kept and be modernized with a variable speed motor drive equipment following issues would need to be considered before making a final installation choice.

The cable layout should be checked and all the insulations on the cable and the motor shall be measured against each other phase and to ground/ chassis and PE and still be conform to the newest installation norms.

In any case, even a shielded cable is installed, then it is recommended to use a sine wave filter covering the differential (symmetrical) and common mode (asymmetrical) aspects as described in chapter 3.3.2 Sinus Plus differential and common mode sine wave output filter.

## 5.4 LV motor drive with MV-motor or step-down/step-up transformer application

With a step-up isolation transformer\* a cost effective LV motor drive can control a MV motor. This application requires a sine wave filter to ensure that the step-up transformer is fed by a sine wave voltage. Otherwise the transformer power losses would be high and overheat the transformer. In addition the voltage spikes would overstress the winding isolation and significantly reduce the life time of the transformer. The additional advantage of this system is, that there is no limitation (other than cable voltage drop and losses) of the cable length between the step-up transformer and the MV-motor.

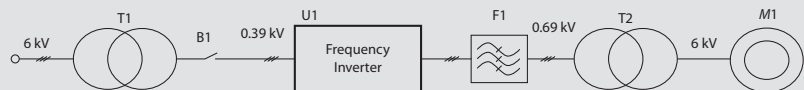

Diagram is showing a step-up motor drive system consisting the step-down transformer T1, the LV-circuit breaker B1, the motor drive U1, the sine wave filter F1, step-up transformer T2 and the MV-motor M1.

The cable length between the sine wave filter F1 and the step-up transformer T2 can be treated in the same way as recommended by Schaffner for the LV-motor cable length. For the cable between the transformer T2 and the MV-motor for EMC considerations unshielded cable can be used, but need to be chosen to fit the application requirements.

The motor drives protective functions and predictive monitoring features need to be considered with regard to the sine wave filter, the step-up transformer and cable length impact.

In particular the earth/ground fault protection of the motor drives does not protect the secondary side of the step-up transformer. For this another protective device needs to be installed.

For the transformer dimensioning the starting torque/current of the MV-motor, the cable length and the voltage drop over the sine wave filter need to be considered.

\* Note: an autotransformer is not allowed.

## 6. Mounting and installation guidelines

### 6.1 Important safety considerations

**Note:** Ensure that all protective earth and ground connections are made at the lowest possible impedance. Remove paint or other isolation materials to achieve good electrical contact. To keep common mode/high frequency effects low a proper large surface connection is required.

**Note:** For safety reasons, open style or IP00 LC sine wave filters must be installed in cabinets or rooms, to prevent access of non-qualified persons to the filters.

**Warning:** Do not operate the filter outside of specifications.

**Note:** LC sine wave filters must be mounted in a clean, dry location which protects the product from any liquids, corrosive vapours, dust, abrasive debris and aggressive gases.

## 6.2 General application notes

### NOTICE

Filter suitability for a given application must ultimately be determined by the user (the party that is putting the filter into operation) on a case by case basis. Schaffner will not assume liability for any consequential downtimes or damages resulting from use of filters outside their specifications.

### NOTICE

Output filters must be mounted in a clean, dry location (enclosures, cabinets, closed rooms). Contaminants such as oils, liquids, corrosive vapours, abrasive debris, dust and aggressive gases must be kept away of the filter and enclosure.

### Standard products

Standard catalogue filters must be used for the published applications and operated within the published technical specifications.

### Custom products

Custom filters must be used for the bespoke application and operated within the provided and mutually agreed technical specifications.

### NOTICE

Output filters are design-in products by definition. Their functionality and suitability must be determined with a proper design-in process, involving electrical, mechanical and thermal verification within the final equipment.



Filter installation, start-up, operation and maintenance (if any) have to be carried out by a trained, certified and authorized electrician or technician, who is familiar with the safety procedures in electrical systems, if needed in accordance with NEC and all local electrical codes and regulations and in particular of three-phase power systems.



High voltage potentials are involved in the operation of this product. Always remove power before touching energized and electrical conductive parts of the filter, and let ample time elapse for the capacitors to discharge to safe levels (< 42 V). Residual voltages are to be measured both line to line and line to earth.



Always connect the filter to protective earth (PE) first, and then continue with the wiring of phase terminals. When decommissioning the filter, remove the PE connection at the end. The sine wave filter must not be operating without connected motor.





Follow the general installation notes closely. Ensure that cooling slots (if any) are free from obstructions that could inhibit efficient air circulation. Operate the filter within its electrical, mechanical, thermal and ambient specifications at all times.



Special attention should be paid to cable dimensioning, fuses, grounding, shutdown, disconnection, and overcurrent protection.



Output filters are lossy electrical components. Filter surfaces and terminals may get hot under full load operating conditions and can exceed surface temperature  $> 80\text{ }^{\circ}\text{C}$ .



Always practice the safety procedures defined by your company and by applicable national electric codes when handling, installing, operating or maintaining electrical equipment.

In case of uncertainty and questions please contact your local Schaffner partner for assistance.

### 6.3 General installation notes

- ! Please read and follow the safety and application notes above.
- ! Carefully inspect the shipping container and the product prior to the installation. In case of visual damage, don't install the filter and file a claim with the freight carrier involved.
- ! Filters may be heavy. Follow the instructions for lifting heavy equipment defined by your company.
- ! Mount the filter to a conductive surface free of paint/lacquer. Use an appropriately sized threaded bolt for every mounting hole/slot provided by the filter flange. The strength class of the bolt must be determined by the installer, depending upon filter weight and the material of the mounting surface.
- ! Connect the filter to the protective earth (PE) terminal(s). Remove all line side power, then connect the phase terminal(s) and capacitor bank (if separate) to the designated terminals of the filter. The output filter label indicates the connection sides (inverter or motor side).
- ! For the electrical connection of the filter terminals, apply the torques recommended on the filter label and/or in the published filter datasheets.
- ! Cable or busbar cross sections have to be chosen in accordance with national and international electric codes and applicable product standards governing the equipment that will incorporate the filter.
- ! Some filters provide additional terminals, e.g. for overtemperature monitoring. These features have to be properly used before energizing the filter. If uncertain, please consult your local Schaffner representative.

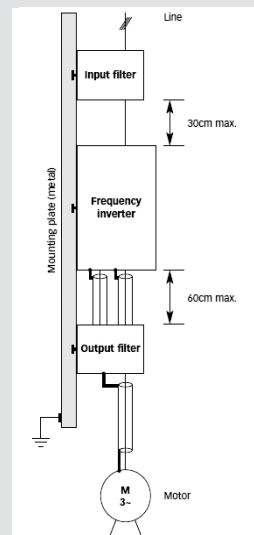

### 6.4 Mechanical mounting

Lift the filter with appropriate crane using lifting eye bolts (if available) – smaller types may be lifted manually by two persons (no lifting eye bolt applicable).



For units  $\geq 75$  A the separate capacitor banks can be mounted aside the inductance with a minimum air distance of 150 mm. Due to the heat dissipation of the inductance it is not recommended to mount the capacitor bank above or on top of the inductance.

*Permitted mounting positions:*

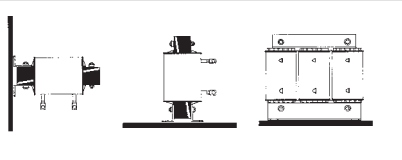

*FN5045 up to 115 A:*

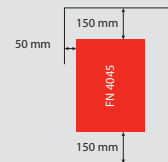

*Prohibited mounting positions:*

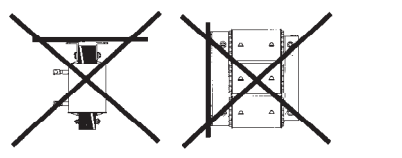

The pictures above show permitted and prohibited mounting positions. The mounting on a vertical plate (top left picture) is limited to IP00 products with a maximum weight of 25 kg or for IP20 products of FN5045 series (far right picture) up to 115 A. Use all available mounting holes and select the correct screws and washers in order to ensure a reliable mounting and to do justice to the weight of these products. Apply torques appropriate for the strength class of the screws and washers you are using. Specifications can be obtained from the supplier of the screws and washers.

### 6.5 Wiring and cabling

The filter rating has to be compatible with the drives to which it is connected. All drives manufacturer installation and safety instructions must be fulfilled. The installation and wiring must be in accordance and be conform with the local standards and applicable codes (e.g. NEC).

The typical block schematic below is shown for a motor load but the load can be multiple motors or a transformer instead. Drives and load cable selection/ placement should be in accordance with all local electrical standards and regulations.

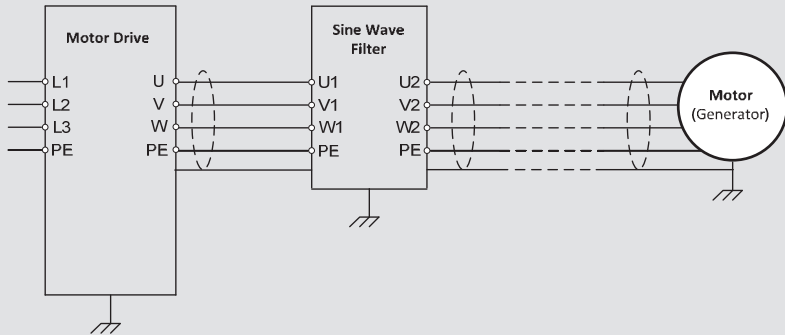

In many applications a shielded cable may not be required when a sine wave filter is applied with a motor drive. Anyhow, due to other existing interference influences of common mode disturbances Schaffner does recommend to use shielded motor cables to avoid back-coupling of radiated interferences to the mains cable at the frequency range from 1–30 MHz.

Because of interference reasons, ensure that the motor cable is installed and arranged separate or with enough distance to other cables or wires. In any case avoid parallel cable layout. In case this is not possible, e. g. encoder- or tachometer cable, then a metal separation shield or tube is recommended.

If possible, the sine wave filter and the motor drive should be mounted on the same conductive mounting plate. At least the motor drive and the sine wave filter shall be connected with a flat copper ribbon. Because of EMI reasons and voltage spikes at the filter input terminals the cable connection between the motor drive and sine wave filter needs to be as short as possible (max. 2–3 m). For electromagnetic emission reasons the shield shall be connected EMC conform on all ends on a solid large connection area with the smallest possible impedance.

This EMC measure can only be considered to be efficient, if the ends of the cable shield are put in proper HF low-impedance contact with the chassis of the motor, the filter and the frequency converter.

In case sine wave filters are installed in cabinets, the shield of the motor cable needs to be connected at the cabinet entry point.

To minimize the coupling capacity and inductivity reserve cable length need to be avoided.

Connect spare wires in the cable on both sides to ground for adding a supplementary shielding effect.

Filters with separate capacitor bank must be connected as follows:

Caution:

U1, V1, W1 cable connection towards drive

U2, V2, W2 cable connection toward motor

Filter may be damaged when cables are swapped!

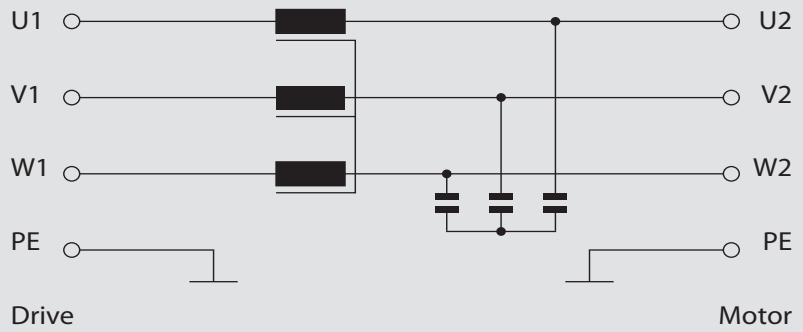

In order to get the maximum benefit out of your output filter application and installation, please also consult "Basics in EMC and Power Quality", published in the download section of [www.schaffner.com](http://www.schaffner.com).

These additional guidelines provide helpful hints for HF-grounding, shielding, proper cable routing etc.

## Headquarters, global innovation and development center

### Schaffner Group

Nordstrasse 11  
4542 Luterbach  
Schweiz  
T +41 32 681 66 26  
F +41 32 681 66 30  
info@schaffner.com  
www.schaffner.com

To find your local partner within Schaffner's global network, please go to [www.schaffner.com](http://www.schaffner.com)

© 2012 Schaffner Group  
Specifications are subject to change within notice. The latest version of the data sheets can be obtained from the website. All trademarks recognized.

Schaffner is an ISO-registered company. Its products are designed and manufactured under the strict quality and environmental requirements of the ISO 9001 and ISO 14001 standards.

This document has been carefully checked. However, Schaffner does not assume any liability for errors or inaccuracies.

## Sales and application centers

### China

**Schaffner EMC Ltd. Shanghai**  
T20-3, No 565 Chuangye Road  
Pudong New Area  
Shanghai 201201  
T +86 21 3813 9500  
F +86 21 3813 9501 / 02  
cschina@schaffner.com  
www.schaffner.com

### Finland

**Schaffner Oy**  
Sauvonrinne 19 H  
08500 Lohja  
T +358 19 35 72 71  
F +358 19 32 66 10  
finlandsales@schaffner.com

### France

**Schaffner EMC S.A.S.**  
112, Quai de Bezons  
95103 Argenteuil  
T +33 1 34 34 30 60  
F +33 1 39 47 02 28  
francesales@schaffner.com

### Germany

**Schaffner Deutschland GmbH**  
Schoemperlenstrasse 12B  
76185 Karlsruhe  
T +49 721 56910  
F +49 721 569110  
germanysales@schaffner.com

### Italy

**Schaffner EMC S.r.l.**  
Via Galileo Galilei, 47  
20092 Cinisello Balsamo (MI)  
T +39 02 66 04 30 45/47  
F +39 02 61 23 943  
italysales@schaffner.com

### Japan

**Schaffner EMC K.K.**  
Mitsui-Seimei Sangenjaya Bldg. 7F  
1-32-12, Kamiyuma, Setagaya-ku  
Tokyo 154-0011  
T +81 3 5712 3650  
F +81 3 5712 3651  
japansales@schaffner.com  
www.schaffner.jp

### Singapore

**Schaffner EMC Pte Ltd.**  
Blk 3015A Ubi Road 1  
05-09 Kampong Ubi Industrial Estate  
T +65 6377 3283  
F +65 6377 3281  
singaporesales@schaffner.com

### Spain

**Schaffner EMC España**  
Calle Caléndula 93  
Miniparc III, Edificio E  
El Soto de la Moraleja  
Alcobendas  
28109 Madrid  
T +34 618 176 133  
spainsales@schaffner.com

### Sweden

**Schaffner EMC AB**  
Turebergstorg 1, 6  
19147 Sollentuna  
T +46 8 5792 1121 / 22  
F +46 8 92 96 90  
swedensales@schaffner.com

### Switzerland

**Schaffner EMV AG**  
Nordstrasse 11  
4542 Luterbach  
T +41 32 681 66 26  
F +41 32 681 66 41  
sales@schaffner.ch

### Taiwan

**Schaffner EMV Ltd.**  
6th Floor, No 413  
Rui Guang Road  
Neihu District  
Taipei City 114  
T +886 2 87525050  
F +886 2 87518086  
taiwansales@schaffner.com

### Thailand

**Schaffner EMC Co. Ltd.**  
Northern Region Industrial Estate  
67 Moo 4 Tambon Ban Klang  
Amphur Muang P.O. Box 14  
Lamphun 51000  
T +66 53 58 11 04  
F +66 53 58 10 19  
thailandsales@schaffner.com

### UK

**Schaffner Ltd.**  
5 Ashville Way  
Molly Millars Lane  
Wokingham  
Berkshire RG41 2PL  
T +44 118 9770070  
F +44 118 9792969  
uksales@schaffner.com  
www.schaffner.uk.com

### USA

**Schaffner EMC Inc.**  
52 Mayfield Avenue  
Edison, New Jersey 08837  
T +1 732 225 9533  
F +1 732 225 4789  
usasales@schaffner.com  
www.schaffner.com/us