

ACS800

User's Manual Sine Filters



Sine Filters ACS800

User's Manual

3AFE68389178 REV G
EN
EFFECTIVE: 15.05.2008

Safety instructions

Overview

This chapter states the general safety instructions that must be followed when installing and operating drives with sine filters.

The material in this chapter must be studied before attempting any work on the filters.

In addition to the safety instructions given below, read the complete safety instructions of the specific drive (presented in the *Hardware Manual* accompanying the drive) you are working on.

General safety instructions



WARNING! All electrical installation and maintenance work on the drive should be carried out by qualified electricians.

The drive and adjoining equipment must be properly earthed.

Do not attempt any work on a powered drive. After switching off the supply voltage, always allow the intermediate circuit capacitors 5 minutes to discharge before working on the frequency converter, the motor or the motor cable. It is good practice to check (with a voltage indicating instrument) that the drive is in fact discharged before beginning work.

The motor cable terminals of the drive are at a dangerously high voltage when mains power is applied, regardless of motor operation.

There can be dangerous voltages inside the drive from external control circuits even when the drive mains power is shut off. Exercise appropriate care when working on the unit. Neglecting these instructions can cause physical injury or death.

Sine filter safety instructions

The capacitors of the sine filter are discharged via the drive. Wait 5 minutes after switching off the supply voltage before starting work on the filter. The voltage between each output terminal of the drive (U2, V2, W2) and earth must be measured with a multimeter (impedance at least 1 megaohm) to ensure that the drive is discharged before beginning work.

If work is to be done on the sine filter capacitors, the voltage over the capacitors must be measured to ensure they are discharged.

Table of contents

Safety instructions

Overview	5
General safety instructions	5
Sine filter safety instructions	5

Table of contents

About this manual

What this chapter contains	11
Intended audience	11
What this manual contains	11
Related manuals	11

Sine filters with ACS800 drives

What this chapter contains	13
General	13
Voltage drop	13
Motor cable length	14
Peak voltage	14
Bearing currents	14
Parameter settings before use	14
95.04 EX/SIN REQUEST	14
Output frequency	14
Ambient conditions	14
Effect on the protective functions of the drive	14
ACS800-01 and sine filters	15
Installation, enclosure and cooling	15
Motor cabling	15
Rating table for ACS800-01 drives with a sine filter	15
ACS800-02 and sine filters	17
Installation, enclosure and cooling	17
Motor cabling	18
Rating table for ACS800-02 drives with a sine filter	19
ACS800-04 and sine filters	20
Installation, enclosure and cooling (Frames R2 ... R6)	20
Installation, enclosure and cooling (Frames R7 and R8)	20
Motor cabling	21
Rating table for ACS800-04 drives with a sine filter	21
ACS800-07 and sine filters	24
Enclosure and cooling	24
Motor cabling	24
Rating table for ACS800-07 sine filter drives	24
ACS800-11 and sine filters	26

Installation, enclosure and cooling	26
Motor cabling	26
Rating table for ACS800-11 sine filter drives	26
ACS800-17 and sine filters	27
Enclosure and cooling	27
Motor cabling	27
Rating table for ACS800-17 sine filter drives	27
ACS800-31 and sine filters	29
Installation, enclosure and cooling	29
Motor cabling	29
Rating table for ACS800-31 sine filter drives	29
ACS800-37 and sine filters	30
Enclosure and cooling	30
Motor cabling	30
Rating table for ACS800-37 sine filter drives	30

Appendix – Step-up applications

What this chapter contains	33
Principle of a step-up drive system	33
Cable type	34
Cable between drive and transformer primary	34
Cable between transformer secondary and motor	34
Effect on the protective functions of the drive	34
Earth (Ground) fault protection (Parameter 30.17)	34
External fault function (Parameter 30.03)	34
Transformer dimensioning	35
Required data	35
Secondary side	36
Primary side	36
Example	37
Motor	37
Cable	37
Secondary side	37
Primary side	37
Transformer specification sheet	38
Parameter settings before use	39
95.04 EX/SIN REQUEST	39
26.03 IR COMPENSATION	39
26.04 IR STEP-UP FREQ	39
Example	41

Illustrations

What this chapter contains	43
NSIN0006-5...NSIN0140-5, NSIN0011-7...NSIN0120-7	44
Dimensions	44
IP00	44
IP23	45
Photographs	46
IP00 (example)	46

IP23 (example)	46
IP23, cover removed (example)	47
NSIN0210-6, NSIN0315-6, NSIN0485-6 for ACS800-02/04	48
Circuit diagram	48
Dimensional drawing – choke module	49
Installation example	50
NSIN0900-6, NSIN1380-6 for ACS800-02/04	52
Circuit diagram	52
Cooling fan wiring	53
Dimensional drawing – choke module (NSIN0900-6)	54
Dimensional drawing – choke module (NSIN1380-6)	55
Installation example (NSIN0900-6)	56
Installation example (NSIN1380-6)	58
ACS800-07 with NSIN0210-6 or NSIN0315-6	59
ACS800-07 with NSIN0315-6 and EMC filter +E202	61
ACS800-07 with NSIN0485-6	63
ACS800-07 with NSIN0485-6 and EMC filter +E202	65
ACS800-07 with NSIN0900-6 or NSIN1380-6	67
ACS800-07 with NSIN0900-6 and EMC filter +E202	69

About this manual

What this chapter contains

This chapter describes the intended audience and contents of the manual.

Intended audience

The manual is intended for the people who are responsible for installing, commissioning and using sine filters with ACS800 drives. The reader is expected to have a basic knowledge of electrical fundamentals, electrical wiring practices, the drive, and the use of the drive control panel.

What this manual contains

Safety instructions gives safety instructions. See also the complete safety instructions in the *Hardware Manual* of the drive.

Sine filters with ACS800 drives gives general information on the sine filters available for the ACS800 series of drives.

Illustrations includes drawings, photos and circuit diagrams of the sine filters.

Appendix – Step-up applications contains information on step-up applications that employ sine filters.

Related manuals

This manual is to be used in conjunction with the *Hardware Manual* and the *Firmware Manual* delivered with the drive.

Sine filters with ACS800 drives

What this chapter contains

This chapter gives information on using sine filters with ACS800 single drives.

General

Sine filters are low-pass filters that suppress the high frequency components of the drive output. The sine filters available for the ACS800 consist of single- or three-phase reactors and delta- or star-connected capacitors.

The following diagram shows a drive system with a sine filter.

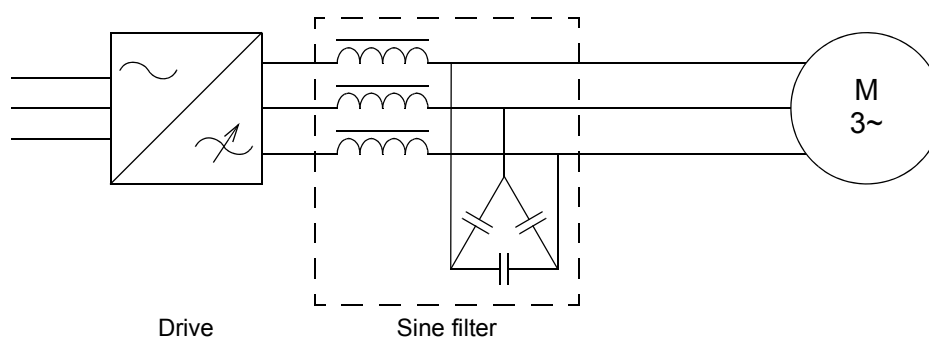

The sine filters are used in conjunction with the ACS800 Standard Application Program. The Scalar motor control mode (instead of DTC mode) is used with a sine filter.

Voltage drop

At a frequency of 50 Hz and nominal drive output current, the sine filter drive decreases the output voltage as follows:

Nominal supply voltage (V AC)	Approximate voltage drop of the drive and the filter (%)			
	ACS800-01	ACS800-04 (Frames R2...R6)	ACS800-04 (Frames R7, R8)	ACS800-02 ACS800-07
400	10	10	15	15
500	10	10	13	13
690	10	10	10	10

The voltage drop must be taken into account when dimensioning the motor and the drive since decreasing the motor voltage will increase the current if the power is kept at a constant level. At 60 Hz the voltage drop is approximately 20% higher.

The voltage drop of the sine filter decreases the maximum available torque at the motor. Therefore, operation above the field weakening point (FWP) and high overloads are not recommended.

Motor cable length

The cable between the sine filter and the motor is not limited in length. However, long motor cables cause an additional voltage drop which must be taken into account in the dimensioning of the motor and the drive.

Peak voltage

The peak phase-to-phase voltage with the sine filter is approximately $1.5 \times U_N$; the peak phase-to-ground voltage is approximately $2 \times U_N$.

Bearing currents

The sine filter will reduce circulating-type and shaft grounding-type bearing currents.

Parameter settings before use

The following drive parameter settings should be made before starting up a drive equipped with a sine filter.

95.04 EX/SIN REQUEST

The parameter must be set to SIN or EX&SIN. For more information, see the *Firmware Manual* of the drive.

Output frequency

The sine filter is designed for operation within the frequency range of 0.5 ... 120 Hz. However, with non-regenerative drives without a brake chopper, it is recommended that the drive output frequency be less than $1.1 \times \text{FWP}$ (field weakening point) because of possible self-excitation of the motor.

If a brake chopper is used and the maximum frequency exceeds $1.1 \times \text{FWP}$, parameter **27.06 BC CTRL MODE** must be set to COMMON DC.

Ambient conditions

The ambient condition requirements for the ACS800 also apply to the sine filter(s). See the *Hardware Manual* of the drive.

Effect on the protective functions of the drive

The sine filter and/or long motor cables may cause impairments in the protective functions of the drive such as the overcurrent, short circuit, and motor phase loss protections. See the *Firmware Manual* for more information on these protections.

ACS800-01 and sine filters

Installation, enclosure and cooling

Sine filters for ACS800-01 are available in IP00 and IP23. IP00 filters must be installed in an adequate enclosure or cabinet to ensure safety. The free space around the filter must be at least one third (1/3) of dimension A shown in the dimension drawing on page 44. IP23 filters can be installed side by side. The filters are cooled by natural convection; it must be made sure that there is enough cooling air available and that the hot air can freely escape the filter enclosure or cubicle.

Motor cabling

The cable length between the filter and the motor is not restricted. All other cabling requirements for the ACS800 also apply to the filters. See the *Hardware Manual* of the drive.

Rating table for ACS800-01 drives with a sine filter

Drive type ACS800-01-...	Frame	Filter type	$I_{cont,max}$	$P_{cont,max}$	*Heat dis- sipation	**Air flow	*Noise level	Degree of protection	Height	Width	Depth	Weight
			A	kW	W	m ³ /h	dBA	IPxx	mm	mm	mm	kg
Three-phase supply voltage 380 V, 400 V or 415 V												
0005-3	R2	NSIN0006-5	8.5	3	180	35	67	IP00/IP23	160/234	155/230	120/170	6/9
0011-3	R3	NSIN0016-5	19	7.5	350	69	68	IP00/IP23	280/460	240/470	190/270	15/26
0016-3	R3	NSIN0020-5	25	11	450	69	68	IP00/IP23	280/460	240/470	200/270	19/30
0020-3	R3	NSIN0025-5	33	15	560	69	68	IP00/IP23	280/460	240/470	210/270	21/32
0025-3	R4	NSIN0030-5	44	22	630	103	69	IP00/IP23	280/460	240/470	220/270	26/37
0030-3	R4	NSIN0040-5	54	26	730	103	69	IP00/IP23	315/460	300/470	228/270	34/45
0040-3	R5	NSIN0050-5	72	35	950	250	73	IP00/IP23	315/510	300/580	240/325	37/53
0050-3	R5	NSIN0060-5	86	42	1100	250	73	IP00/IP23	320/510	300/580	270/325	53/69
0060-3	R5	NSIN0070-5	102	52	1500	250	73	IP00/IP23	415/510	360/580	210/325	66/82
0075-3	R5	NSIN0100-5	125	63	1800	250	75	IP00/IP23	415/620	360/700	225/425	69/99
0070-3	R6	NSIN0100-5	141	71	1800	405	75	IP00/IP23	415/620	360/700	225/425	69/99
0100-3	R6	NSIN0120-5	164	84	2200	405	75	IP00/IP23	415/620	360/700	240/425	75/105
0120-3	R6	NSIN0140-5	199	102	2700	405	75	IP00/IP23	450/620	400/700	500/525	120/165
0135-3	R6	NSIN 0315-6	225	110	3900	1105	79	IP00	2060	400	600	230
0205-3	R6	NSIN 0315-6	260	130	5500	1105	79	IP00	2060	400	600	230
Three-phase supply voltage 380 V, 400 V, 415 V, 440 V, 460 V, 480 V or 500 V												
0006-5	R2	NSIN0006-5	8.1	4.4	200	35	67	IP00/IP23	160/234	155/230	120/170	6/9
0016-5	R3	NSIN0016-5	19	11	440	69	68	IP00/IP23	280/460	240/470	190/270	15/26
0020-5	R3	NSIN0020-5	25	15	550	69	68	IP00/IP23	280/460	240/470	200/270	19/30
0025-5	R3	NSIN0025-5	33	20	600	69	68	IP00/IP23	280/460	240/470	210/270	21/32
0030-5	R4	NSIN0030-5	42	26	700	103	69	IP00/IP23	280/460	240/470	220/270	26/37
0040-5	R4	NSIN0040-5	47	29	900	103	69	IP00/IP23	315/460	300/470	228/270	34/45
0050-5	R5	NSIN0050-5	65	40	1100	250	73	IP00/IP23	315/510	300/580	240/325	37/53
0060-5	R5	NSIN0060-5	79	48	1300	250	73	IP00/IP23	320/510	300/580	270/325	53/69
0070-5	R5	NSIN0070-5	94	60	1800	250	73	IP00/IP23	415/510	360/580	210/325	66/82
0105-5	R5	NSIN0100-5	125	78	2500	250	75	IP00/IP23	415/620	360/700	225/425	69/99
0100-5	R6	NSIN0100-5	124	78	2300	405	75	IP00/IP23	415/620	360/700	225/425	69/99
0120-5	R6	NSIN0120-5	155	99	2500	405	75	IP00/IP23	415/620	360/700	240/425	75/105
0140-5	R6	NSIN0140-5	177	114	3500	405	75	IP00/IP23	450/620	400/700	500/525	120/165
0165-5	R6	NSIN0315-6	225	137	4600	1105	79	IP00	2060	400	600	230
0255-5	R6	NSIN0315-6	260	160	6100	1105	79	IP00	2060	400	600	230
Notes: *Combined value for drive and filter. **Applies to drive only.												

Drive type ACS800-01-...	Frame	Filter type	$I_{cont,max}$	$P_{cont,max}$	*Heat dis- sipation	**Air flow	*Noise level	Degree of protection	Height	Width	Depth	Weight
			A	kW	W	m ³ /h	dBA	IPxx	mm	mm	mm	kg
Three-phase supply voltage 525 V, 550 V, 575 V, 600 V, 660 V, or 690 V												
0011-7	R4	NSIN0011-7	13	10.6	400	103	67	IP00/IP23	280/460	240/470	190/270	20/31
0016-7	R4	NSIN0020-7	17	14	460	103	67	IP00/IP23	280/460	240/470	220/270	26/37
0020-7	R4	NSIN0020-7	22	18	560	103	68	IP00/IP23	280/460	240/470	220/270	26/37
0025-7	R4	NSIN0025-7	25	21	650	103	68	IP00/IP23	320/510	300/580	222/325	35/51
0030-7	R4	NSIN0040-7	31	26	740	103	69	IP00/IP23	320/510	300/580	235/325	40/56
0040-7	R4	NSIN0040-7	34	29	820	103	70	IP00/IP23	320/510	300/580	235/325	40/56
0050-7	R5	NSIN0060-7	48	40	1000	250	73	IP00/IP23	330/510	300/580	275/325	57/73
0060-7	R5	NSIN0060-7	52	46	1200	250	73	IP00/IP23	330/510	300/580	275/325	57/73
0070-7	R6	NSIN0070-7	79	69	1500	405	75	IP00/IP23	415/510	360/580	240/325	75/91
0100-7	R6	NSIN0120-7	93	82	1900	405	75	IP00/IP23	500/510	420/580	290/325	126/142
0120-7	R6	NSIN0120-7	104	92	2300	405	75	IP00/IP23	500/510	420/580	290/325	126/142
0145-7	R6	NSIN0210-6	134	113	4700	1105	79	IP00	2060	400	600	250
0175-7	R6	NSIN0210-6	148	125	4700	1105	79	IP00	2060	400	600	250

Notes:
*Combined value for drive and filter.
**Applies to drive only.

ACS800-02 and sine filters

Installation, enclosure and cooling

Sine filters for ACS800-02 are available as IP00 kits that include the choke unit, capacitors and cooling fan. The filters must be installed in an adequate enclosure or cabinet to ensure safety.

The following table lists the contents of the filter kits.

Filter type	Part designation	Qty	Name	Type	Technical data
NSIN0210-6	L40	1	Choke module	NSUL0210-6	150 kg
	C41_43.1	3	AC capacitor	B25834-S0226-K*14	22 μ F
	Y41	1	Cooling fan	W2E200-HH38-06	230 V AC, 50/60 Hz, 67/79 W
NSIN0315-6	L40	1	Choke module	NSUL0315-6	150 kg
	C41_43.1	3	AC capacitor	B25834-D7336-K004	33 μ F
	Y41	1	Cooling fan	W2E200-HH38-06	230 V AC, 50/60 Hz, 67/79 W
NSIN0485-6	L40	1	Choke module	NSUL0485-6	160 kg
	C41_43.1	3	AC capacitor	B25834-D7606-K*14-1	60 μ F
	Y41	1	Cooling fan	W2E200-HH38-06	230 V AC, 50/60 Hz, 67/79 W
NSIN0900-6	L40	1	Choke module	NSUL0900-6	370 kg
	C41_43.1	3	AC capacitor	B25834-D7826-K**4-1	82 μ F
	Y41	1	Cooling fan	D4E225-CC01-39	230 V AC, 50/60 Hz, 2.8 A
		1	Wire set		For fan Y41
NSIN1380-6	L40	1	Choke module	NSUL1380-6	490 kg
	C41_43.1, C41_43.2	6	AC capacitor	B25834-D7606-K*14-1	60 μ F
	Y41	1	Cooling fan	D4E225-CC01-39	230 V AC, 50/60 Hz, 2.8 A
		1	Wire set		For fan Y41

The choke module must be adequately supported, and fixed horizontally (all types) and vertically (NSIN0210-6, NSIN0315-6, NSIN0485-6).

The capacitors of the filter need not be in the airflow. However, they should not be installed in the hot region above the choke module. The dimensions of the capacitors are as follows:

Filter type	Quantity of capacitors	Diameter (mm)	Height of can (mm)	Height including terminals (mm)
NSIN0210-6 NSIN0315-6	3	99	176	223
NSIN0485-6	3	122	176	223
NSIN0900-6	3	122	248	325
NSIN1380-6	6	122	176	223

The overpressure disconnecter can extend the capacitor by 8 mm. Therefore sufficient space must be left above the terminals when mounting the capacitors.

The capacitors are connected in delta. In NSIN1380-6, two capacitors are connected in parallel. The minimum cross-sectional area of capacitor wiring is as follows:

Filter type	Wire size (mm ²)
NSIN0210-6, NSIN0315-6, NSIN0485-6	35
NSIN0900-6, NSIN1380-6	50

See the chapter *Illustrations* for cabinet assembly examples.

The filters are cooled by a fan; the airflow must be directed through the choke unit, and recirculation prevented e.g. with an air baffle. It must be made sure that there is enough cooling air available and that the hot air can freely escape the filter enclosure or cubicle.

The cooling fan must be provided with a 230 V AC supply.

Motor cabling

The maximum cable length between the drive and the filter is 5 metres. If the required length exceeds 5 metres, du/dt filters must be used at the drive output. The cable length between the filter and the motor is not restricted. All other cabling requirements for the ACS800 also apply to the filters. See the *Hardware Manual* of the drive.

Rating table for ACS800-02 drives with a sine filter

Drive type ACS800-02-...	Frame	Filter type	$I_{cont.max}$	$P_{cont.max}$	*Heat dis- sipation	Air flow			*Noise level	Degree of protection	Height	Width	Depth	Weight
						Drive	Filter	Total						
			A	kW	W	m ³ /h	m ³ /h	m ³ /h	dBA	IPxx	mm	mm	mm	kg
Three-phase supply voltage 380 V, 400 V or 415 V														
0140-3	R7	NSIN0315-6	206	100	4100	540	700	1240	79	IP00	**2060	**400	**600	***230
0170-3	R7	NSIN0315-6	248	120	4900	540	700	1240	79	IP00	**2060	**400	**600	***230
0210-3	R7	NSIN0315-6	266	130	5600	540	700	1240	79	IP00	**2060	**400	**600	***230
0260-3	R8	NSIN0485-6	445	215	8800	1220	700	1920	80	IP00	**2060	**400	**600	***250
0320-3	R8	NSIN0900-6	521	250	9700	1220	2000	3220	80	IP00	**2120	**1000	**640	***690
0400-3	R8	NSIN0900-6	602	295	11100	1220	2000	3220	80	IP00	**2120	**1000	**640	***690
0440-3	R8	NSIN0900-6	693	340	12100	1220	2000	3220	80	IP00	**2120	**1000	**640	***690
0490-3	R8	NSIN0900-6	720	350	12600	1220	2000	3220	80	IP00	**2120	**1000	**640	***690
Three-phase supply voltage 380 V, 400 V, 415 V, 440 V, 460 V, 480 V or 500 V														
0170-5	R7	NSIN0315-6	196	125	4300	540	700	1240	79	IP00	**2060	**400	**600	***230
0210-5	R7	NSIN0315-6	245	150	5400	540	700	1240	79	IP00	**2060	**400	**600	***230
0260-5	R7	NSIN0315-6	258	160	6200	540	700	1240	79	IP00	**2060	**400	**600	***230
0320-5	R8	NSIN0485-6	440	275	9600	1220	700	1920	80	IP00	**2060	**400	**600	***250
0400-5	R8	NSIN0900-6	515	320	11100	1220	2000	3220	80	IP00	**2120	**1000	**640	***690
0440-5	R8	NSIN0900-6	550	345	11100	1220	2000	3220	80	IP00	**2120	**1000	**640	***690
0490-5	R8	NSIN0900-6	602	375	11900	1220	2000	3220	80	IP00	**2120	**1000	**640	***690
0550-5	R8	NSIN0900-6	684	430	13400	1220	2000	3220	80	IP00	**2120	**1000	**640	***690
0610-5	R8	NSIN0900-6	700	440	14100	1220	2000	3220	80	IP00	**2120	**1000	**640	***690
Three-phase supply voltage 525 V, 550 V, 575 V, 600 V, 660 V, or 690 V														
0140-7	R7	NSIN0210-6	130	115	4000	540	700	1240	78	IP00	**2060	**400	**600	***250
0170-7	R7	NSIN0210-6	142	125	4600	540	700	1240	79	IP00	**2060	**400	**600	***250
0210-7	R7	NSIN0210-6	169	150	6000	540	700	1240	79	IP00	**2060	**400	**600	***250
0320-7	R8	NSIN0485-6	315	280	9000	1220	700	1920	80	IP00	**2060	**400	**600	***250
0400-7	R8	NSIN0485-6	336	300	9700	1220	700	1920	80	IP00	**2060	**400	**600	***250
0440-7	R8	NSIN0485-6	367	330	10700	1220	700	1920	80	IP00	**2060	**400	**600	***250
0550-7	R8	NSIN0485-6	444	395	12300	1220	700	1920	80	IP00	**2060	**400	**600	***250
Notes:														
*Combined value for drive and filter.														
**Estimated for a cabinet that can house the filter.														
***Estimated combined weight of cabinet and filter.														

ACS800-04 and sine filters

Installation, enclosure and cooling (Frames R2 ... R6)

Sine filters for ACS800-04 (Frames R2 ... R6) are available in IP00 and IP23. IP00 filters must be installed in an adequate enclosure or cabinet to ensure safety. The free space around the filter must be at least one third (1/3) of dimension A shown in the dimension drawing on page 44. IP23 filters can be installed side by side. The filters are cooled by natural convection; it must be made sure that there is enough cooling air available and that the hot air can freely escape the filter enclosure or cubicle.

Installation, enclosure and cooling (Frames R7 and R8)

Sine filters for ACS800-04 (Frames R7 and R8) are available as IP00 kits that include the choke unit, capacitors and cooling fan. The filters must be installed in an adequate enclosure or cabinet to ensure safety.

The following table lists the contents of the filter kits.

Filter type	Part designation	Qty	Name	Type	Technical data
NSIN0210-6	L40	1	Choke module	NSUL0210-6	150 kg
	C41_43.1	3	AC capacitor	B25834-S0226-K*14	22 µF
	Y41	1	Cooling fan	W2E200-HH38-06	230 V AC, 50/60 Hz, 67/79 W
NSIN0315-6	L40	1	Choke module	NSUL0315-6	150 kg
	C41_43.1	3	AC capacitor	B25834-D7336-K004	33 µF
	Y41	1	Cooling fan	W2E200-HH38-06	230 V AC, 50/60 Hz, 67/79 W
NSIN0485-6	L40	1	Choke module	NSUL0485-6	160 kg
	C41_43.1	3	AC capacitor	B25834-D7606-K*14-1	60 µF
	Y41	1	Cooling fan	W2E200-HH38-06	230 V AC, 50/60 Hz, 67/79 W
NSIN0900-6	L40	1	Choke module	NSUL0900-6	370 kg
	C41_43.1	3	AC capacitor	B25834-D7826-K**4-1	82 µF
	Y41	1	Cooling fan	D4E225-CC01-39	230 V AC, 50/60 Hz, 2.8 A
		1	Wire set		For fan Y41
NSIN1380-6	L40	1	Choke module	NSUL1380-6	490 kg
	C41_43.1, C41_43.2	6	AC capacitor	B25834-D7606-K*14-1	60 µF
	Y41	1	Cooling fan	D4E225-CC01-39	230 V AC, 50/60 Hz, 2.8 A
		1	Wire set		For fan Y41

The choke module must be adequately supported, and fixed horizontally (all types) and vertically (NSIN0210-6, NSIN0315-6, NSIN0485-6).

The capacitors of the filter need not be in the airflow. However, they should not be installed in the hot region above the choke module. The dimensions of the capacitors are as follows:

Filter type	Quantity of capacitors	Diameter (mm)	Height of can (mm)	Height including terminals (mm)
NSIN0210-6 NSIN0315-6	3	99	176	223
NSIN0485-6	3	122	176	223
NSIN0900-6	3	122	248	325
NSIN1380-6	6	122	176	223

The overpressure disconnecter can extend the capacitor by 8 mm. Therefore sufficient space must be left above the terminals when mounting the capacitors.

The capacitors are connected in delta. In NSIN1380-6, two capacitors are connected in parallel. The minimum cross-sectional area of capacitor wiring is as follows:

Filter type	Wire size (mm ²)
NSIN0210-6, NSIN0315-6, NSIN0485-6	35
NSIN0900-6, NSIN1380-6	50

See the chapter [Illustrations](#) for cabinet assembly examples.

The filters are cooled by a fan; the airflow must be directed through the choke unit, and recirculation prevented e.g. with an air baffle. It must be made sure that there is enough cooling air available and that the hot air can freely escape the filter enclosure or cubicle.

The cooling fan must be provided with a 230 V AC supply.

Motor cabling

For frames R2 to R6, the length of the cable between the drive and the filter is not restricted. For frames R7 and R8, the maximum length is 5 metres; if the required length exceeds 5 metres, du/dt filters must be used at the drive output.

The cable length between the filter and the motor is not restricted. All other cabling requirements for the ACS800 also apply to the filters. See the *Hardware Manual* of the drive.

Rating table for ACS800-04 drives with a sine filter

Drive type ACS800-04-...	Frame	Filter type	$I_{cont,max}$ A	$P_{cont,max}$ kW	*Heat dis- sipation W	Air flow			*Noise level dBA	Degree of protection IPxx	Height mm	Width mm	Depth mm	Weight kg
						Drive m ³ /h	Filter m ³ /h	Total m ³ /h						
Three-phase supply voltage 380 V, 400 V or 415 V														
0005-3	R2	NSIN0006-5	8.5	3	180	35	–	35	67	IP00/IP23	160/234	155/230	120/170	6/9
0011-3	R3	NSIN0016-5	19	7.5	350	69	–	69	68	IP00/IP23	280/460	240/470	190/270	15/26
0016-3	R3	NSIN0020-5	25	11	450	69	–	69	68	IP00/IP23	280/460	240/470	200/270	19/30
0020-3	R3	NSIN0025-5	33	15	560	69	–	69	68	IP00/IP23	280/460	240/470	210/270	21/32
0023-3	R3	NSIN0030-5	39	18.5	630	69	–	69	69	IP00/IP23	280/460	240/470	220/270	26/37
0025-3	R4	NSIN0030-5	44	22	630	103	–	103	69	IP00/IP23	280/460	240/470	220/270	26/37
0030-3	R4	NSIN0040-5	54	26	730	103	–	103	69	IP00/IP23	315/460	300/470	228/270	34/45
0035-3	R4	NSIN0040-5	58	28	730	103	–	103	69	IP00/IP23	315/460	300/470	228/270	34/45
0040-3	R5	NSIN0050-5	72	35	950	250	–	250	73	IP00/IP23	315/510	300/580	240/325	37/53
0050-3	R5	NSIN0060-5	86	42	1100	250	–	250	73	IP00/IP23	320/510	300/580	270/325	53/69
0060-3	R5	NSIN0070-5	102	52	1500	250	–	250	73	IP00/IP23	415/510	360/580	210/325	66/82
0075-3	R5	NSIN0100-5	125	63	1800	250	–	250	75	IP00/IP23	415/620	360/700	225/425	69/99
0070-3	R6	NSIN0100-5	141	71	1800	405	–	405	75	IP00/IP23	415/620	360/700	225/425	69/99
0100-3	R6	NSIN0120-5	164	84	2200	405	–	405	75	IP00/IP23	415/620	360/700	240/425	75/105
0120-3	R6	NSIN0140-5	199	102	2700	405	–	405	75	IP00/IP23	450/620	400/700	500/525	120/165
0135-3	R6	NSIN0315-6	220	110	3900	405	700	1105	79	IP00	2060	400	600	230
0205-3	R6	NSIN0315-6	260	130	5500	405	700	1105	79	IP00	2060	400	600	230
0140-3	R7	NSIN0315-6	206	100	4100	540	700	1240	79	IP00	**2060	**400	**600	***230
0170-3	R7	NSIN0315-6	248	120	4900	540	700	1240	79	IP00	**2060	**400	**600	***230

Notes:
 *Combined value for drive and filter.
 **Estimated for a cabinet that can house the filter.
 ***Estimated combined weight of cabinet and filter.

Drive type ACS800-04-...	Frame	Filter type	$I_{cont,max}$	$P_{cont,max}$	*Heat dis- sipation	Air flow			*Noise level	Degree of protection	Height	Width	Depth	Weight
						Drive	Filter	Total						
						A	kW	W						
0210-3	R7	NSIN0315-6	266	130	5600	540	700	1240	79	IP00	**2060	**400	**600	***230
0260-3	R8	NSIN0485-6	445	215	8800	1220	700	1920	80	IP00	**2060	**400	**600	***250
0320-3	R8	NSIN0900-6	521	250	9700	1220	2000	3220	80	IP00	**2120	**1000	**640	***690
0400-3	R8	NSIN0900-6	602	295	11100	1220	2000	3220	80	IP00	**2120	**1000	**640	***690
0440-3	R8	NSIN0900-6	693	340	12100	1220	2000	3220	80	IP00	**2120	**1000	**640	***690
0490-3	R8	NSIN0900-6	720	350	12600	1220	2000	3220	80	IP00	**2120	**1000	**640	***690
Three-phase supply voltage 380 V, 400 V, 415 V, 440 V, 460 V, 480 V or 500 V														
0006-5	R2	NSIN0006-5	8.1	4.4	200	35	–	35	67	IP00/IP23	160/234	155/230	120/170	6/9
0016-5	R3	NSIN0016-5	19	11	440	69	–	69	68	IP00/IP23	280/460	240/470	190/270	15/26
0020-5	R3	NSIN0020-5	25	15	550	69	–	69	68	IP00/IP23	280/460	240/470	200/270	19/30
0025-5	R3	NSIN0025-5	33	20	600	69	–	69	68	IP00/IP23	280/460	240/470	210/270	21/32
0028-5	R3	NSIN0028-5	37	23	600	69	–	69	68	IP00/IP23	280/460	240/470	210/270	21/32
0030-5	R4	NSIN0030-5	42	26	700	103	–	103	69	IP00/IP23	280/460	240/470	220/270	26/37
0040-5	R4	NSIN0040-5	47	29	900	103	–	103	69	IP00/IP23	315/460	300/470	228/270	34/45
0045-5	R4	NSIN0045-5	56	34	900	103	–	103	69	IP00/IP23	315/460	300/470	228/270	34/45
0050-5	R5	NSIN0050-5	65	40	1100	250	–	250	73	IP00/IP23	315/510	300/580	240/325	37/53
0060-5	R5	NSIN0060-5	79	48	1300	250	–	250	73	IP00/IP23	320/510	300/580	270/325	53/69
0070-5	R5	NSIN0070-5	94	60	1800	250	–	250	73	IP00/IP23	415/510	360/580	210/325	66/82
0105-5	R5	NSIN0100-5	125	78	2500	250	–	250	75	IP00/IP23	415/620	360/700	225/425	69/99
0100-5	R6	NSIN0100-5	124	78	2300	405	–	405	75	IP00/IP23	415/620	360/700	225/425	69/99
0120-5	R6	NSIN0120-5	155	99	2500	405	–	405	75	IP00/IP23	415/620	360/700	240/425	75/105
0140-5	R6	NSIN0140-5	177	114	3500	405	–	405	75	IP00/IP23	450/620	400/700	500/525	120/165
0165-5	R6	NSIN0315-6	196	125	4300	405	700	1105	79	IP00	2060	400	600	230
0255-5	R6	NSIN0315-6	260	160	6100	405	700	1105	79	IP00	2060	400	600	230
0170-5	R7	NSIN0315-6	196	125	4300	540	700	1240	79	IP00	**2060	**400	**600	***230
0210-5	R7	NSIN0315-6	245	150	5400	540	700	1240	79	IP00	**2060	**400	**600	***230
0260-5	R7	NSIN0315-6	258	160	6200	540	700	1240	79	IP00	**2060	**400	**600	***230
0320-5	R8	NSIN0485-6	440	275	9600	1220	700	1920	80	IP00	**2060	**400	**600	***250
0400-5	R8	NSIN0900-6	515	320	11100	1220	2000	3220	80	IP00	**2120	**1000	**640	***690
0440-5	R8	NSIN0900-6	550	345	11100	1220	2000	3220	80	IP00	**2120	**1000	**640	***690
0490-5	R8	NSIN0900-6	602	375	11900	1220	2000	3220	80	IP00	**2120	**1000	**640	***690
0550-5	R8	NSIN0900-6	684	430	13400	1220	2000	3220	80	IP00	**2120	**1000	**640	***690
0610-5	R8	NSIN0900-6	700	440	14100	1220	2000	3220	80	IP00	**2120	**1000	**640	***690
Three-phase supply voltage 525 V, 550 V, 575 V, 600 V, 660 V, or 690 V														
0011-7	R4	NSIN0011-7	13	10.6	400	103	–	103	67	IP00/IP23	280/460	240/470	190/270	20/31
0016-7	R4	NSIN0020-7	17	14	460	103	–	103	67	IP00/IP23	280/460	240/470	220/270	26/37
0020-7	R4	NSIN0020-7	22	18	560	103	–	103	68	IP00/IP23	280/460	240/470	220/270	26/37
0025-7	R4	NSIN0025-7	25	21	650	103	–	103	68	IP00/IP23	320/510	300/580	222/325	35/51
0030-7	R4	NSIN0040-7	31	26	740	103	–	103	69	IP00/IP23	320/510	300/580	235/325	40/56
0040-7	R4	NSIN0040-7	34	29	820	103	–	103	70	IP00/IP23	320/510	300/580	235/325	40/56
0050-7	R5	NSIN0060-7	48	40	1000	250	–	250	73	IP00/IP23	330/510	300/580	275/325	57/73
0060-7	R5	NSIN0060-7	52	46	1200	250	–	250	73	IP00/IP23	330/510	300/580	275/325	57/73
0070-7	R6	NSIN0070-7	79	69	1500	405	–	405	75	IP00/IP23	415/510	360/580	240/325	75/91
0100-7	R6	NSIN0120-7	93	82	1900	405	–	405	75	IP00/IP23	500/510	420/580	290/325	126/142
0120-7	R6	NSIN0120-7	104	92	2300	405	–	405	75	IP00/IP23	500/510	420/580	290/325	126/142
0145-7	R6	NSIN0210-6	134	113	3800	405	700	1105	79	IP00	2060	400	600	250
0175-7	R6	NSIN0210-6	148	125	4700	405	700	1105	79	IP00	2060	400	600	250
0140-7	R7	NSIN0210-6	130	115	4000	540	700	1240	78	IP00	**2060	**400	**600	***250
0170-7	R7	NSIN0210-6	142	125	4800	540	700	1240	79	IP00	**2060	**400	**600	***250
0210-7	R7	NSIN0210-6	169	150	6000	540	700	1240	79	IP00	**2060	**400	**600	***250
0320-7	R8	NSIN0485-6	315	280	9000	1220	700	1920	80	IP00	**2060	**400	**600	***250
0400-7	R8	NSIN0485-6	336	300	9700	1220	700	1920	80	IP00	**2060	**400	**600	***250

Notes:
*Combined value for drive and filter.
**Estimated for a cabinet that can house the filter.
***Estimated combined weight of cabinet and filter.

Drive type ACS800-04-...	Frame	Filter type	$I_{cont,max}$	$P_{cont,max}$	*Heat dis- sipation	Air flow			*Noise level	Degree of protection	Height	Width	Depth	Weight
						Drive	Filter	Total						
			A	kW	W	m ³ /h	m ³ /h	m ³ /h			mm	mm	mm	kg
0440-7	R8	NSIN0485-6	367	330	10700	1220	700	1920	80	IP00	**2060	**400	**600	***250
0550-7	R8	NSIN0485-6	444	395	12300	1220	700	1920	80	IP00	**2060	**400	**600	***250

Notes:
 *Combined value for drive and filter.
 **Estimated for a cabinet that can house the filter.
 ***Estimated combined weight of cabinet and filter.

ACS800-07 and sine filters

Enclosure and cooling

ACS800-07 sine filter drives have the filter fitted in a separate cubicle, protected to IP21, IP22, IP42, IP54 or IP54R.

The filters have a dedicated cooling fan that rotates whenever the drive is powered. As standard, fan and filter overtemperature switches are wired to stop the drive by breaking the DIIL (start interlock) circuit on the RMIO control board.

Motor cabling

The motor cabling is done from the sine filter cubicle of the drive cabinet. The connection points are visible in the drawings in the chapter *Illustrations*.

The cable length between the filter and the motor is not restricted. All other cabling requirements for the ACS800 also apply to the filters. See the *Hardware Manual* of the drive.

Rating table for ACS800-07 sine filter drives

Drive type ACS800-07-...	Frame	Filter type	$I_{cont,max}$	$P_{cont,max}$	Heat dis- sipation	Air flow	Noise level	*Height	*Width	*Depth	Weight
			A	kW	kW	m ³ /h	dBA	mm	mm	mm	kg
Three-phase supply voltage 380 V, 400 V or 415 V											
0140-3	R7	NSIN0315-6	206	100	4	1240	79	2130	1230	646	650
0170-3	R7	NSIN0315-6	248	120	5	1240	79	2130	1230	646	650
0210-3	R7	NSIN0315-6	266	130	6	1240	79	2130	1230	646	650
0260-3	R8	NSIN0485-6	445	215	9	1920	80	2130	1230	646	800
0320-3	R8	NSIN0900-6	521	250	10	3220	80	2130	1830	646	1200
0400-3	R8	NSIN0900-6	602	295	11	3220	80	2130	1830	646	1200
0440-3	R8	NSIN0900-6	693	340	12	3220	80	2130	1830	646	1200
0490-3	R8	NSIN0900-6	720	350	13	3220	80	2130	1830	646	1200
0610-3	1×D4 + 2×R8i	NSIN1380-6	879	430	17	5120	81	2130	2330	646	1700
0770-3	2×D4 + 2×R8i	NSIN1380-6	1111	555	23	5840	81	2130	2630	646	2000
0870-3	2×D4 + 2×R8i	NSIN1380-6	1255	630	25	5840	81	2130	2630	646	2000
1030-3	2×D4 + 2×R8i	2×NSIN0900-6	1452	725	31	7840	82	2130	3830	646	2600
1230-3	2×D4 + 3×R8i	2×NSIN1380-6	1770	885	36	9040	82	2130	4030	646	2600
1540-3	3×D4 + 3×R8i	2×NSIN1380-6	2156	1080	46	9760	82	2130	4230	646	3100
1850-3	3×D4 + 4×R8i	3×NSIN1380-6	2663	1330	56	12960	83	2130	5630	646	4200
Three-phase supply voltage 380 V, 400 V, 415 V, 440 V, 460 V, 480 V or 500 V											
0170-5	R7	NSIN0315-6	196	125	4	1240	79	2130	1230	646	650
0210-5	R7	NSIN0315-6	245	150	5	1240	79	2130	1230	646	650
0260-5	R7	NSIN0315-6	258	160	6	1240	79	2130	1230	646	650
0320-5	R8	NSIN0485-6	440	275	10	1920	80	2130	1230	646	800
0400-5	R8	NSIN0900-6	515	320	11	3220	80	2130	1830	646	1200
0440-5	R8	NSIN0900-6	550	345	11	3220	80	2130	1830	646	1200
0490-5	R8	NSIN0900-6	602	375	12	3220	80	2130	1830	646	1200
0550-5	R8	NSIN0900-6	684	430	13	3220	80	2130	1830	646	1200
0610-5	R8	NSIN0900-6	700	440	14	3220	80	2130	1830	646	1200
0760-5	1×D4 + 2×R8i	NSIN1380-6	883	565	20	5120	81	2130	2330	646	1700
0910-5	2×D4 + 2×R8i	NSIN1380-6	1050	675	24	5840	81	2130	2630	646	2000
1090-5	2×D4 + 2×R8i	NSIN1380-6	1258	805	28	5840	81	2130	2630	646	2000
1210-5	2×D4 + 2×R8i	2×NSIN0900-6	1372	880	33	7840	82	2130	3830	646	2600
1540-5	2×D4 + 3×R8i	2×NSIN1380-6	1775	1135	41	9040	82	2130	4030	646	2600
Note: *Applies to drives protected to IP21 with bottom cable entry/exit.											

Drive type ACS800-07-....	Frame	Filter type	$I_{\text{cont.max}}$	$P_{\text{cont.max}}$	Heat dis- sipation	Air flow	Noise level	*Height	*Width	*Depth	Weight
			A	kW	kW	m ³ /h	dBA	mm	mm	mm	kg
1820-5	3xD4 + 3xR8i	2xNSIN1380-6	2037	1305	48	9760	82	2130	4230	646	3100
2310-5	3xD4 + 4xR8i	3xNSIN1380-6	2670	1710	63	12960	83	2130	5630	646	4200
Three-phase supply voltage 525 V, 550 V, 575 V, 600 V, 660 V, or 690 V											
0140-7	R7	NSIN0210-6	130	115	4	1240	78	2130	1230	646	650
0170-7	R7	NSIN0210-6	142	125	5	1240	79	2130	1230	646	650
0210-7	R7	NSIN0210-6	169	150	6	1240	79	2130	1230	646	650
0320-7	R8	NSIN0485-6	315	280	9	1920	80	2130	1230	646	800
0400-7	R8	NSIN0485-6	336	300	10	1920	80	2130	1230	646	800
0440-7	R8	NSIN0485-6	367	330	11	1920	80	2130	1230	646	800
0550-7	R8	NSIN0485-6	444	395	12	1920	80	2130	1230	646	800
0750-7	1xD4 + 2xR8i	NSIN0900-6	628	575	20	5120	81	2130	2330	646	1600
0870-7	1xD4 + 2xR8i	NSIN0900-6	729	665	24	5120	81	2130	2330	646	1600
1060-7	1xD4 + 2xR8i	NSIN1380-6	885	810	27	5120	81	2130	2330	646	1700
1160-7	2xD4 + 2xR8i	NSIN1380-6	953	870	30	5840	81	2130	2630	646	2000
1500-7	2xD4 + 3xR8i	2xNSIN0900-6	1258	1150	39	9040	82	2130	4030	646	2800
1740-7	2xD4 + 3xR8i	2xNSIN0900-6	1414	1290	45	9040	82	2130	4030	646	2800
2120-7	2xD4 + 4xR8i	2xNSIN1380-6	1774	1620	56	10240	82	2130	4430	646	3200
2320-7	3xD4 + 4xR8i	2xNSIN1380-6	1866	1705	60	10960	82	2130	4630	646	3400
2900-7	3xD4 + 5xR8i	2xNSIN1380-6	2321	2070	72	14160	83	2130	5830	646	4300
3190-7	3xD4 + 6xR8i	3xNSIN1380-6	2665	2435	82	15360	83	2130	6030	646	4500
3490-7	4xD4 + 6xR8i	3xNSIN1380-6	2770	2530	89	16080	83	2130	6430	646	4800
Note: *Applies to drives protected to IP21 with bottom cable entry/exit.											

ACS800-11 and sine filters

Installation, enclosure and cooling

Sine filters for ACS800-11 are available in IP00 and IP23. IP00 filters must be installed in an adequate enclosure or cabinet to ensure safety. The free space around the filter must be at least one third (1/3) of dimension A shown in the dimension drawing on page 44. IP23 filters can be installed side by side. The filters are cooled by natural convection; it must be made sure that there is enough cooling air available and that the hot air can freely escape the filter enclosure or cubicle.

Motor cabling

The cable length between the filter and the motor is not restricted. All other cabling requirements for the ACS800 also apply to the filters. See the *Hardware Manual* of the drive.

Rating table for ACS800-11 sine filter drives

Drive type ACS800-11-...	Frame	Filter type	$I_{cont,max}$	$P_{cont,max}$	Heat dis- sipation	Air flow	Noise level	*Height	*Width	*Depth	Weight
			A	kW	kW	m ³ /h	dBA	mm	mm	mm	kg
Three-phase supply voltage 380 V, 400 V or 415 V											
0016-3	R5	NSIN0025-5	34	15	670	350	73	280/460	240/470	210/270	21/32
0020-3	R5	NSIN0030-5	38	19	750	350	73	280/460	240/470	220/270	26/37
0025-3	R5	NSIN0030-5	47	22	860	350	73	280/460	240/470	220/270	26/37
0030-3	R5	NSIN0040-5	59	30	1120	350	73	315/460	300/470	228/270	34/45
0040-3	R5	NSIN0050-5	72	37	1350	350	73	315/510	300/580	240/325	37/53
0050-3	R5	NSIN0060-5	86	45	1590	350	73	320/510	300/580	270/325	53/69
0060-3	R6	NSIN0100-5	120	55	2060	450	76	415/620	360/700	225/425	69/99
0070-3	R6	NSIN0100-5	150	75	2700	450	76	415/620	360/700	225/425	69/99
0100-3	R6	NSIN0120-5	165	90	3000	450	76	415/620	360/700	240/425	75/105
Three-phase supply voltage 380 V, 400 V, 415 V, 440 V, 460 V, 480 V or 500 V											
0020-5	R5	NSIN0020-5	31	19	760	350	73	280/460	240/470	200/270	19/30
0025-5	R5	NSIN0025-5	36	22	900	350	73	280/460	240/470	210/270	21/32
0030-5	R5	NSIN0030-5	47	30	1100	350	73	280/460	240/470	220/270	26/37
0040-5	R5	NSIN0040-5	58	37	1300	350	73	315/460	300/470	228/270	34/45
0050-5	R5	NSIN0050-5	70	45	1600	350	73	315/510	300/580	240/325	37/53
0060-5	R5	NSIN0060-5	82	55	1900	350	73	320/510	300/580	270/325	53/69
0070-5	R6	NSIN0100-5	120	75	2700	405	76	415/620	360/700	225/425	69/99
0100-5	R6	NSIN0100-5	139	90	3100	405	76	415/620	360/700	225/425	69/99
0120-5	R6	NSIN0120-5	156	110	3600	405	76	415/620	360/700	240/425	75/105
Three-phase supply voltage 525 V, 550 V, 575 V, 600 V, 660 V, or 690 V											
0060-7	R6	NSIN0060-7	52	55	1900	405	76	330/510	300/580	275/325	57/73
0070-7	R6	NSIN0070-7	79	75	2600	405	76	415/510	360/580	240/325	75/91
0100-7	R6	NSIN0120-7	93	90	3100	405	76	500/510	420/580	290/325	126/142
Note: *Applies to drives protected to IP21 with bottom cable entry/exit.											

ACS800-17 and sine filters

Enclosure and cooling

ACS800-17 sine filter drives have the filter fitted in a separate cubicle, protected to IP21, IP22, IP42, IP54 or IP54R.

The filters have a dedicated cooling fan that rotates whenever the drive is powered. As standard, fan and filter overtemperature switches are wired to stop the drive by breaking the DIIL (start interlock) circuit on the RMIO control board.

Motor cabling

The motor cabling is done from the sine filter cubicle of the drive cabinet. The connection points are visible in the drawings in the chapter [Illustrations](#).

The cable length between the filter and the motor is not restricted. All other cabling requirements for the ACS800 also apply to the filters. See the *Hardware Manual* of the drive.

Rating table for ACS800-17 sine filter drives

Drive type ACS800-17-	Frame	Filter type	$I_{cont,max}$	$P_{cont,max}$	Heat dis- sipation	Air flow	Noise level	*Height IP21/22/ 42	*Height IP54	*Height IP54R	*Width	*Depth	*Depth top exit	Weight
			A	kW	kW	m ³ /h	dBA	mm	mm	mm	mm	mm	mm	kg
Three-phase supply voltage 380 V, 400 V or 415 V														
0140-3	R7i	NSIN0315-6	202	110	7,0	2000	80	2130	2315	2051	1030	646	646	650
0170-3	R7i	NSIN0315-6	250	132	8,1	2000	80	2130	2315	2051	1030	646	646	650
0210-3	R8i	NSIN0485-6	292	160	9,3	3860	81	2130	2315	2051	1630	646	646 **	1200
0260-3	R8i	NSIN0485-6	370	200	12	3860	81	2130	2315	2051	1630	646	646 **	1200
0320-3	R8i	NSIN0900-6	469	250	15	5160	81	2130	2315	2051	2230	646	646 **	1650
0390-3	R8i	NSIN0900-6	565	315	19	5160	81	2130	2315	2051	2230	646	646 **	1650
0490-3	R8i	NSIN0900-6	704	400	26	5160	81	2130	2315	2051	2230	646	646 **	1650
0640-3	2x R8i	NSIN1380-6	919	500	29	8400	82	2130	2315	2051	3430	646	776	2750
0770-3	2x R8i	NSIN1380-6	1111	630	37	8400	82	2130	2315	2051	3430	646	776	2750
0960-3	2x R8i	2xNSIN0900-6	1379	800	50	10400	82	2130	2315	2051	4730	646	776	3400
1070-3	3x R8i	2xNSIN1380-6	1535	900	53	14240	83	2130	2315	2051	5530	646	776	4550
1370-3	3x R8i	2xNSIN1380-6	1978	1200	73	14240	83	2130	2315	2051	5530	646	776	4550
1810-3	4x R8i	3xNSIN1380-6	2610	1600	96	18800	83	2130	2315	2051	7130	646	776	5850
Three-phase supply voltage 380 V, 400 V, 415 V, 440 V, 460 V, 480 V or 500 V														
0170-5	R7i	NSIN0315-6	200	132	7,2	2000	80	2130	2315	2051	1030	646	646	650
0210-5	R7i	NSIN0315-6	245	160	8,9	2000	80	2130	2315	2051	1030	646	646	650
0260-5	R8i	NSIN0485-6	302	200	11	3860	81	2130	2315	2051	1630	646	646 **	1200
0320-5	R8i	NSIN0485-6	365	250	13	3860	81	2130	2315	2051	1630	646	646 **	1200
0400-5	R8i	NSIN0900-6	455	315	16	5160	81	2130	2315	2051	2230	646	646 **	1650
0460-5	R8i	NSIN0900-6	525	355	18	5160	81	2130	2315	2051	2230	646	646 **	1650
0510-5	R8i	NSIN0900-6	595	400	21	5160	81	2130	2315	2051	2230	646	646 **	1650
0580-5	R8i	NSIN0900-6	670	500	26	5160	82	2130	2315	2051	2230	646	646	1650
0780-5	2x R8i	NSIN1380-6	892	630	30	8400	82	2130	2315	2051	3430	646	776	2750
0870-5	2x R8i	NSIN1380-6	1005	710	37	8400	82	2130	2315	2051	3430	646	776	2750
1140-5	2x R8i	2xNSIN0900-6	1313	900	50	10400	83	2130	2315	2051	4730	646	776	3400
1330-5	3x R8i	2xNSIN1380-6	1528	1120	53	14240	83	2130	2315	2051	5530	646	776	4550
1640-5	3x R8i	2xNSIN1380-6	1884	1400	73	14240	83	2130	2315	2051	5530	646	776	4550
2160-5	4x R8i	3xNSIN1380-6	2486	1800	96	18800	83	2130	2315	2051	7130	646	776	5850
Note:														
*Applies to drives protected to IP21 with bottom cable entry/exit.														
** 776 mm if 1st. environment and common motor terminal not used														

Drive type ACS800-17-	Frame	Filter type	$I_{cont.max}$	$P_{cont.max}$	Heat dis- sipation	Air flow	Noise level	*Height IP21/22/ 42	*Height IP54	*Height IP54R	*Width	*Depth	*Depth top exit	Weight
			A	kW										
Three-phase supply voltage 525 V, 550 V, 575 V, 600 V, 660 V, or 690 V														
0160-7	R7i	NSIN0210-6	132	110	8,2	2000	79	2130	2315	2051	1030	646	646	650
0200-7	R7i	NSIN0210-6	150	132	9,5	2000	79	2130	2315	2051	1030	646	646	650
0260-7	R8i	NSIN0315-6	201	200	13	3860	80	2130	2315	2051	1630	646	646 **	1200
0320-7	R8i	NSIN0315-6	279	250	17	3860	80	2130	2315	2051	1630	646	646 **	1200
0400-7	R8i	NSIN0485-6	335	315	20	3860	81	2130	2315	2051	1630	646	646 **	1200
0440-7	R8i	NSIN0485-6	382	355	20	3860	81	2130	2315	2051	1630	646	646 **	1200
0540-7	R8i	NSIN0485-6	447	450	24	3860	81	2130	2315	2051	1630	646	646 **	1200
0790-7	2x R8i	NSIN0900-6	659	630	39	8400	81	2130	2315	2051	3430	646	776	1900
0870-7	2x R8i	NSIN0900-6	729	710	39	8400	81	2130	2315	2051	3430	646	776	1900
1050-7	2x R8i	NSIN1380-6	876	900	46	8400	82	2130	2315	2051	3430	646	776	2750
1330-7	3x R8i	NSIN1380-6	1112	1120	59	12240	82	2130	2315	2051	4230	646	776	3800
1510-7	3x R8i	2xNSIN0900-6	1256	1250	68	14240	82	2130	2315	2051	5530	646	776	4450
1980-7	4x R8i	2xNSIN1380-6	1657	1700	90	16800	83	2130	2315	2051	6130	646	776	5100
2780-7	5x R8i	3xNSIN1380-6	2321	2300	117	23920	83	2130	2315	2051	8430	646	776	7050
2940-7	6x R8i	3xNSIN1380-6	2460	2500	133	25200	83	2130	2315	2051	8630	646	776	7200
Note: *Applies to drives protected to IP21 with bottom cable entry/exit. ** 776 mm If 1st. environment and common motor terminal not used														

ACS800-31 and sine filters

Installation, enclosure and cooling

Sine filters for ACS800-01 are available in IP00 and IP23. IP00 filters must be installed in an adequate enclosure or cabinet to ensure safety. The free space around the filter must be at least one third (1/3) of dimension A shown in the dimension drawing on page 44. IP23 filters can be installed side by side. The filters are cooled by natural convection; it must be made sure that there is enough cooling air available and that the hot air can freely escape the filter enclosure or cubicle.

Motor cabling

The cable length between the filter and the motor is not restricted. All other cabling requirements for the ACS800 also apply to the filters. See the *Hardware Manual* of the drive.

Rating table for ACS800-31 sine filter drives

Drive type ACS800-31-...	Frame	Filter type	$I_{\text{cont,max}}$	$P_{\text{cont,max}}$	Heat dis- sipation	Air flow	Noise level	*Height	*Width	*Depth	Weight
			A	kW	kW	m ³ /h	dBA	mm	mm	mm	kg
Three-phase supply voltage 380 V, 400 V or 415 V											
0016-3	R5	NSIN0025-5	34	15	670	350	73	280/460	240/470	210/270	21/32
0020-3	R5	NSIN0030-5	38	19	750	350	73	280/460	240/470	220/270	26/37
0025-3	R5	NSIN0030-5	47	22	860	350	73	280/460	240/470	220/270	26/37
0030-3	R5	NSIN0040-5	59	30	1120	350	73	315/460	300/470	228/270	34/45
0040-3	R5	NSIN0050-5	72	37	1350	350	73	315/510	300/580	240/325	37/53
0050-3	R5	NSIN0060-5	86	45	1590	350	73	320/510	300/580	270/325	53/69
0060-3	R6	NSIN0100-5	120	55	2060	405	76	415/620	360/700	225/425	69/99
0070-3	R6	NSIN0100-5	150	75	2700	405	76	415/620	360/700	225/425	69/99
0100-3	R6	NSIN0120-5	165	90	3000	405	76	415/620	360/700	240/425	75/105
Three-phase supply voltage 380 V, 400 V, 415 V, 440 V, 460 V, 480 V or 500 V											
0020-5	R5	NSIN0020-5	31	19	760	350	73	280/460	240/470	200/270	19/30
0025-5	R5	NSIN0025-5	36	22	900	350	73	280/460	240/470	210/270	21/32
0030-5	R5	NSIN0030-5	47	30	1100	350	73	280/460	240/470	220/270	26/37
0040-5	R5	NSIN0040-5	58	37	1300	350	73	315/460	300/470	228/270	34/45
0050-5	R5	NSIN0050-5	70	45	1600	350	73	315/510	300/580	240/325	37/53
0060-5	R5	NSIN0060-5	82	55	1900	350	73	320/510	300/580	270/325	53/69
0070-5	R6	NSIN0100-5	120	75	2700	405	76	415/620	360/700	225/425	69/99
0100-5	R6	NSIN0100-5	139	90	3100	405	76	415/620	360/700	225/425	69/99
0120-5	R6	NSIN0120-5	156	110	3600	405	76	415/620	360/700	240/425	75/105
Three-phase supply voltage 525 V, 550 V, 575 V, 600 V, 660 V, or 690 V											
0060-7	R6	NSIN0060-7	52	55	1900	405	76	330/510	300/580	275/325	57/73
0070-7	R6	NSIN0070-7	79	75	2600	405	76	415/510	360/580	240/325	75/91
0100-7	R6	NSIN0120-7	93	90	3100	405	76	500/510	420/580	290/325	126/142
Note: *Applies to drives protected to IP21 with bottom cable entry/exit.											

ACS800-37 and sine filters

Enclosure and cooling

ACS800-37 sine filter drives have the filter fitted in a separate cubicle, protected to IP21, IP22, IP42, IP54 or IP54R.

The filters have a dedicated cooling fan that rotates whenever the drive is powered. As standard, fan and filter overtemperature switches are wired to stop the drive by breaking the DIIL (start interlock) circuit on the RMIO control board.

Motor cabling

The motor cabling is done from the sine filter cubicle of the drive cabinet. The connection points are visible in the drawings in the chapter [Illustrations](#).

The cable length between the filter and the motor is not restricted. All other cabling requirements for the ACS800 also apply to the filters. See the *Hardware Manual* of the drive.

Rating table for ACS800-37 sine filter drives

Drive type ACS800-17-	Frame	Filter type	$I_{cont,max}$	$P_{cont,max}$	Heat dis- sipation	Air flow	Noise level	*Height IP21/22/ 42	*Height IP54	*Height IP54R	*Width	*Depth	*Depth top exit	Weight
			A	kW	kW	m ³ /h	dBA	mm	mm	mm	mm	mm	mm	kg
Three-phase supply voltage 380 V, 400 V or 415 V														
0140-3	R7i	NSIN0315-6	202	110	7,0	2000	80	2130	2315	2051	1030	646	646	650
0170-3	R7i	NSIN0315-6	250	132	8,1	2000	80	2130	2315	2051	1030	646	646	650
0210-3	R8i	NSIN0485-6	292	160	9,3	3860	81	2130	2315	2051	1630	646	646 **	1200
0260-3	R8i	NSIN0485-6	370	200	12	3860	81	2130	2315	2051	1630	646	646 **	1200
0320-3	R8i	NSIN0900-6	469	250	15	5160	81	2130	2315	2051	2230	646	646 **	1650
0390-3	R8i	NSIN0900-6	565	315	19	5160	81	2130	2315	2051	2230	646	646 **	1650
0510-3	R8i	NSIN0900-6	730	400	26	5160	81	2130	2315	2051	2230	646	646 **	1650
0640-3	2x R8i	NSIN1380-6	919	500	29	8400	82	2130	2315	2051	3430	646	776	2750
0770-3	2x R8i	NSIN1380-6	1111	630	37	8400	82	2130	2315	2051	3430	646	776	2750
0960-3	2x R8i	2xNSIN0900-6	1379	800	50	10400	82	2130	2315	2051	4730	646	776	3400
1070-3	3x R8i	2xNSIN1380-6	1535	900	53	14240	83	2130	2315	2051	5530	646	776	4550
1370-3	3x R8i	2xNSIN1380-6	2056	1200	73	14240	83	2130	2315	2051	5530	646	776	4550
Three-phase supply voltage 525 V, 550 V, 575 V, 600 V, 660 V, or 690 V														
0170-7	R7i	NSIN0210-6	139	132	8,2	2000	79	2130	2315	2051	1030	646	646	650
0210-7	R7i	NSIN0210-6	162	160	9,5	2000	79	2130	2315	2051	1030	646	646	650
0260-7	R8i	NSIN0315-6	201	200	13	3860	80	2130	2315	2051	1630	646	646 **	1200
0320-7	R8i	NSIN0315-6	279	250	17	3860	80	2130	2315	2051	1630	646	646 **	1200
0400-7	R8i	NSIN0485-6	335	315	20	3860	81	2130	2315	2051	1630	646	646 **	1200
0440-7	R8i	NSIN0485-6	382	355	20	3860	81	2130	2315	2051	1630	646	646 **	1200
0540-7	R8i	NSIN0485-6	447	450	24	3860	81	2130	2315	2051	1630	646	646 **	1200
0790-7	2x R8i	NSIN0900-6	659	630	39	8400	81	2130	2315	2051	3430	646	776	1900
0870-7	2x R8i	NSIN0900-6	729	710	39	8400	81	2130	2315	2051	3430	646	776	1900
1160-7	2x R8i	NSIN1380-6	953	900	46	8400	82	2130	2315	2051	3430	646	776	2750
1330-7	3x R8i	NSIN1380-6	1112	1120	59	12240	82	2130	2315	2051	4230	646	776	3800
1510-7	3x R8i	2xNSIN0900-6	1256	1250	68	14240	82	2130	2315	2051	5530	646	776	4450
2320-7	4x R8i	2xNSIN1380-6	1866	1800	90	16800	83	2130	2315	2051	6130	646	776	5100
2780-7	5x R8i	3xNSIN1380-6	2321	2300	117	23920	83	2130	2315	2051	8430	646	776	7050
3170-7	6x R8i	3xNSIN1380-6	2665	2700	133	25200	83	2130	2315	2051	8630	646	776	7200
Note:														
*Applies to drives protected to IP21 with bottom cable entry/exit.														
** 776 mm If 1st. environment and common motor terminal not used														

Drive type ACS800-17-	Frame	Filter type	$I_{cont,max}$	$P_{cont,max}$	Heat dis- sipation	Air flow	Noise level	*Height IP21/22/ 42	*Height IP54	*Height IP54R	*Width	*Depth	*Depth top exit	Weight
			A	kW	kW	m ³ /h	dBA	mm	mm	mm	mm	mm	mm	kg
1810-3	4x R8i	3xNSIN1380-6	2610	1600	96	18800	83	2130	2315	2051	7130	646	776	5850
Three-phase supply voltage 380 V, 400 V, 415 V, 440 V, 460 V, 480 V or 500 V														
0170-5	R7i	NSIN0315-6	200	132	7,2	2000	80	2130	2315	2051	1030	646	646	650
0210-5	R7i	NSIN0315-6	245	160	8,9	2000	80	2130	2315	2051	1030	646	646	650
0260-5	R8i	NSIN0485-6	302	200	11	3860	81	2130	2315	2051	1630	646	646 **	1200
0320-5	R8i	NSIN0485-6	365	250	13	3860	81	2130	2315	2051	1630	646	646 **	1200
0400-5	R8i	NSIN0900-6	455	315	16	5160	81	2130	2315	2051	2230	646	646 **	1650
0460-5	R8i	NSIN0900-6	525	355	18	5160	81	2130	2315	2051	2230	646	646 **	1650
0510-5	R8i	NSIN0900-6	595	400	21	5160	81	2130	2315	2051	2230	646	646 **	1650
0610-5	R8i	NSIN0900-6	700	500	26	5160	82	2130	2315	2051	2230	646	646 **	1650
0780-5	2x R8i	NSIN1380-6	892	630	30	8400	82	2130	2315	2051	3430	646	776	2750
0870-5	2x R8i	NSIN1380-6	1005	710	37	8400	82	2130	2315	2051	3430	646	776	2750
1160-5	2x R8i	2xNSIN0900-6	1338	900	50	10400	83	2130	2315	2051	4730	646	776	3400
1330-5	3x R8i	2xNSIN1380-6	1528	1120	53	14240	83	2130	2315	2051	5530	646	776	4550
1820-5	3x R8i	2xNSIN1380-6	2037	1400	73	14240	83	2130	2315	2051	5530	646	776	4550
2200-5	4x R8i	3xNSIN1380-6	2529	1800	96	18800	83	2130	2315	2051	7130	646	776	5850
Three-phase supply voltage 525 V, 550 V, 575 V, 600 V, 660 V, or 690 V														
0170-7	R7i	NSIN0210-6	139	132	8,2	2000	79	2130	2315	2051	1030	646	646	650
0210-7	R7i	NSIN0210-6	162	160	9,5	2000	79	2130	2315	2051	1030	646	646	650
0260-7	R8i	NSIN0315-6	201	200	13	3860	80	2130	2315	2051	1630	646	646 **	1200
0320-7	R8i	NSIN0315-6	279	250	17	3860	80	2130	2315	2051	1630	646	646 **	1200
0400-7	R8i	NSIN0485-6	335	315	20	3860	81	2130	2315	2051	1630	646	646 **	1200
Three-phase supply voltage 525 V, 550 V, 575 V, 600 V, 660 V, or 690 V														
0170-7	R7i	NSIN0210-6	139	132	8,2	2000	79	2130	2315	2051	1030	646	646	650
0210-7	R7i	NSIN0210-6	162	160	9,5	2000	79	2130	2315	2051	1030	646	646	650
0260-7	R8i	NSIN0315-6	201	200	13	3860	80	2130	2315	2051	1630	646	646 **	1200
0320-7	R8i	NSIN0315-6	279	250	17	3860	80	2130	2315	2051	1630	646	646 **	1200
0400-7	R8i	NSIN0485-6	335	315	20	3860	81	2130	2315	2051	1630	646	646 **	1200
0440-7	R8i	NSIN0485-6	382	355	20	3860	81	2130	2315	2051	1630	646	646 **	1200
0540-7	R8i	NSIN0485-6	447	450	24	3860	81	2130	2315	2051	1630	646	646 **	1200
0790-7	2x R8i	NSIN0900-6	659	630	39	8400	81	2130	2315	2051	3430	646	776	1900
0870-7	2x R8i	NSIN0900-6	729	710	39	8400	81	2130	2315	2051	3430	646	776	1900
1160-7	2x R8i	NSIN1380-6	953	900	46	8400	82	2130	2315	2051	3430	646	776	2750
1330-7	3x R8i	NSIN1380-6	1112	1120	59	12240	82	2130	2315	2051	4230	646	776	3800
1510-7	3x R8i	2xNSIN0900-6	1256	1250	68	14240	82	2130	2315	2051	5530	646	776	4450
2320-7	4x R8i	2xNSIN1380-6	1866	1800	90	16800	83	2130	2315	2051	6130	646	776	5100
2780-7	5x R8i	3xNSIN1380-6	2321	2300	117	23920	83	2130	2315	2051	8430	646	776	7050
3170-7	6x R8i	3xNSIN1380-6	2665	2700	133	25200	83	2130	2315	2051	8630	646	776	7200

Note:

*Applies to drives protected to IP21 with bottom cable entry/exit.

** 776 mm If 1st. environment and common motor terminal not used

Appendix – Step-up applications

What this chapter contains

This chapter contains additional information on step-up applications.

All parameter numbers refer to the ACS800 Standard Application Program (version ASXR7210 or later).

Principle of a step-up drive system

The main idea of a step-up application is that it enables the use of a medium-voltage motor with a low-voltage drive.

The following diagram shows a step-up drive system consisting of the drive, a sine filter, a transformer, cables and the motor.

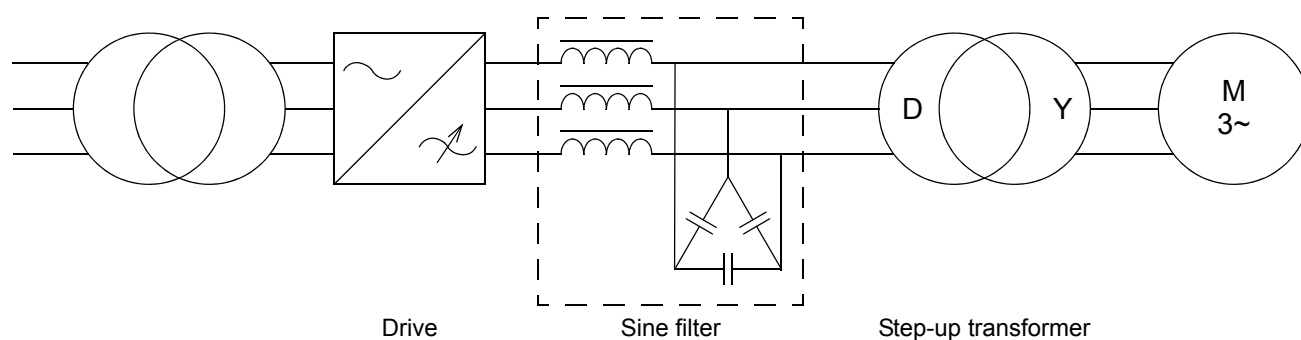

Cable type

Cable between drive and transformer primary

The cabling between the drive and the step-up transformer is the normal motor cable type. Recommendations are given in the *Hardware Manual* of the drive.

Cable between transformer secondary and motor

The cable is to be chosen according to the application. Unshielded cable can be used.

Effect on the protective functions of the drive

The sine filter, step-up transformer and/or long motor cables may cause impairments in the protective functions of the drive such as the overcurrent, short circuit, and motor phase loss protections. See the *Firmware Manual* for more information on these protections.

Earth (Ground) fault protection (Parameter 30.17)

Note that this function does not protect the secondary side of the step-up transformer. Any external device installed for this purpose by the customer can be connected to a digital input of the drive. See [External fault function \(Parameter 30.03\)](#) below.

External fault function (Parameter 30.03)

Signals from protective devices installed by the customer can be connected to RMIO (Motor Control and I/O board) digital inputs DI1 ... DI6 using this parameter.

Transformer dimensioning

Transformer selection is based on the demands of the application. DC components together with the demands for starting torque form the need for voltage boost. A special transformer must be used when the required starting torque is over 50% of nominal torque, or if the motor cable length is over 300 metres (984 ft).

The transformer kVA rating must be at least equal to the apparent power (S) of the motor.

An autotransformer is not allowed.

The following is a quick calculation for transformer dimensioning. The capacitive reactance of the cable on the secondary side is not taken into account. Furthermore, the voltage drop over the sine filter is estimated.

Required data

Motor: $U_n, I_n, \cos \varphi_n, f_n$

Cable R_c, L_c, length

If cable characteristics are not known, typical values can be used:

$$R_c = 0,27 \frac{\Omega}{\text{km}}$$

$$L_c = 0,33 \frac{\text{mH}}{\text{km}}$$

Motor data:

Nominal impedance $Z_m = \frac{U_n}{I_n \sqrt{3}}$

Resistive component $R_m = Z_m \cos(\varphi_n)$

Reactive component $X_m = Z_m \sqrt{1 - \cos^2(\varphi_n)}$

Cable reactance at frequency f is calculated as follows: $X_c = 2\pi f L_c$

Secondary side

The following diagram represents the secondary side of a step-up system.

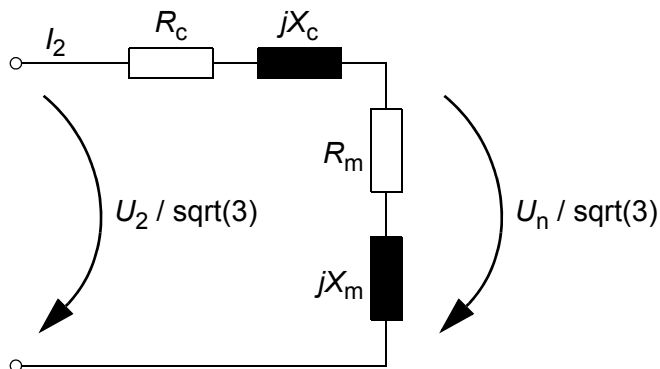

The impedance of the secondary side equals

$$Z_1 = \sqrt{(R_c + R_m)^2 + (X_c + X_m)^2}$$

The system is dimensioned using the nominal current of the motor:

$$I_2 = I_n$$

Thus, the minimum voltage for the transformer secondary equals

$$U_2 = \sqrt{3} \cdot I_2 \cdot Z_1$$

Primary side

It can be assumed that the primary voltage of the transformer is about 10% lower than the supply voltage of the drive because of the voltage drop in the sine filter and the drive. The primary voltage U_1 equals

- $0.85 \times 400 \text{ V} = \mathbf{340 \text{ V}}$ (for 400 V drives)
- $0.87 \times 500 \text{ V} = \mathbf{435 \text{ V}}$ (for 500 V drives)
- $0.9 \times 690 \text{ V} = \mathbf{620 \text{ V}}$ (for 690 V drives).

Example

The nominal voltage of the drive in this calculation is 690 V.

Motor

$$U_n = 3300 \text{ V}$$

$$I_n = 106 \text{ A}$$

$$f_n = 50 \text{ Hz}$$

$$\cos(\varphi_n) = 0,82$$

$$Z_m = \frac{3300}{106 \cdot \sqrt{3}} \Omega \approx 17,97 \Omega$$

$$\Rightarrow R_m = 17,97 \cdot 0,82 \Omega \approx 14,74 \Omega$$

$$X_m = 17,97 \cdot \sqrt{1 - 0,82^2} \Omega \approx 10,29 \Omega$$

Cable

Length = 5 km

$$R_c = 0,27 \frac{\Omega}{\text{km}} \Rightarrow R_c = 5 \cdot 0,27 \Omega \approx 1,35 \Omega$$

$$L_c = 0,33 \frac{\text{mH}}{\text{km}} \Rightarrow L_c = 2 \cdot \pi \cdot 50 \cdot 0,33 \cdot 10^{-3} \approx 0,52 \Omega$$

Secondary side

$$Z_1 = \sqrt{(1,35 + 14,74)^2 + (0,52 + 10,29)^2} \Omega \approx 19,38 \Omega$$

Current for the secondary side:

$$I_2 = I_n = 106 \text{ A}$$

Thus, the minimum voltage for the secondary side equals

$$U_2 = \sqrt{3} \cdot 106 \text{ A} \cdot 19,38 \Omega \approx 3558 \text{ V}$$

The secondary voltage of the transformer is thus chosen as follows

$$U_{N2} = 3560 \text{ V}$$

Primary side

The primary voltage of the transformer is

$$U_{N1} = 0,9 \cdot 690 \text{ V} \approx 620 \text{ V}$$

Transformer specification sheet

The table below lists items to be submitted to the manufacturer of the transformer.

Parameter	Specification
1. Quantity and type of transformers	
2. Rated power, primary S_n (kVA)	
3. Rated power, secondary S_2 (kVA)	
4. Rated voltage, primary U_1 (V)	
5. Tapping range (%)	
6. Rated voltage, secondary U_2 (V)	
7. Rated current, primary I_1 (A)	
8. Rated current, secondary I_2 (A)	
9. Motor load S_m (kVA)	
10. Max. current, primary (1 min / 10 min) (A)	
11. Primary system SC level S_c (MVA)	
12. Impedance voltage U_{k1-2} (%)	
13. Ambient temperature t_{amb} (°C)	
14. No-load losses P_0 (kW)	
15. Load losses P_k at S_n (kW)	
16. Direct current losses P_{dc} at S_n (kW)	
17. Additional losses P_{add} at S_n and at nominal frequency (kW)	
18. Load losses at drive kVA including harmonics P_{kc} (kW)	
19. Vector group of transformer	
20. DC component (mV)	150
21. Current harmonics (% / Hz)	1.1 / 250 0.5 / 350 2.1 / 950 0.9 / 1150
22. Voltage boost (% / Hz)	
23. Total weight	
24. Input frequency range (Hz)	
25. Accessories	
26. Tests	
27. Deviations from specification	

Parameter settings before use

The following drive parameter settings should be made before starting up a step-up drive system.

95.04 EX/SIN REQUEST

Set the parameter to SIN or EX&SIN. For more information, see the *Firmware Manual* of the drive.

26.03 IR COMPENSATION

26.04 IR STEP-UP FREQ

Voltage boosting is used in step-up applications to achieve a higher starting torque. The demand for a high starting torque affects the transformer design because boosting the voltage at low frequencies increases transformer flux. The voltage boost compensates resistive losses in the cables, step-up transformer, and motor. Since voltage cannot be fed to the transformer at 0 Hz, special IR compensation is used in step-up applications. Full IR compensation starts around slip frequency. The voltage boost is set using parameters 26.03 IR COMPENSATION and 26.04 IR STEP-UP FREQ.

The voltage boost is set using parameters 26.03 IR COMPENSATION and 26.04 IR STEP-UP FREQ.

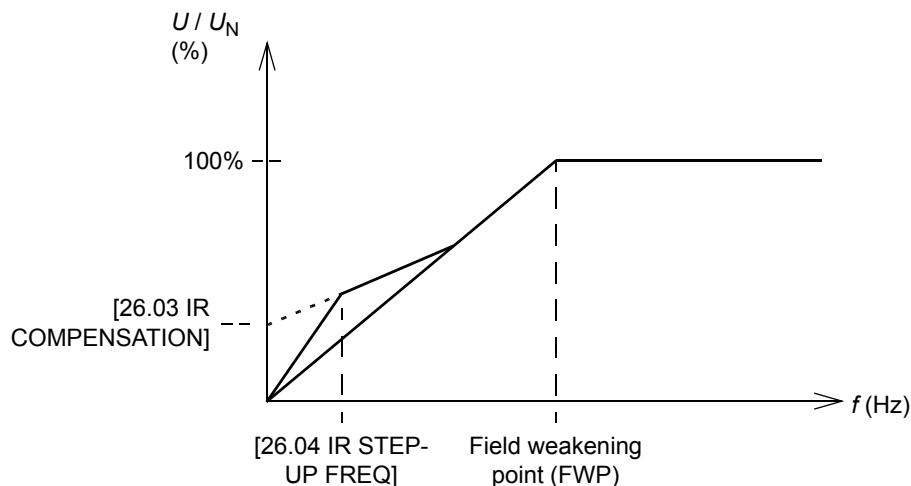

Without IR compensation, the motor can only give a very low starting torque at its nominal current. A typical relation between the starting torque and current is shown below.

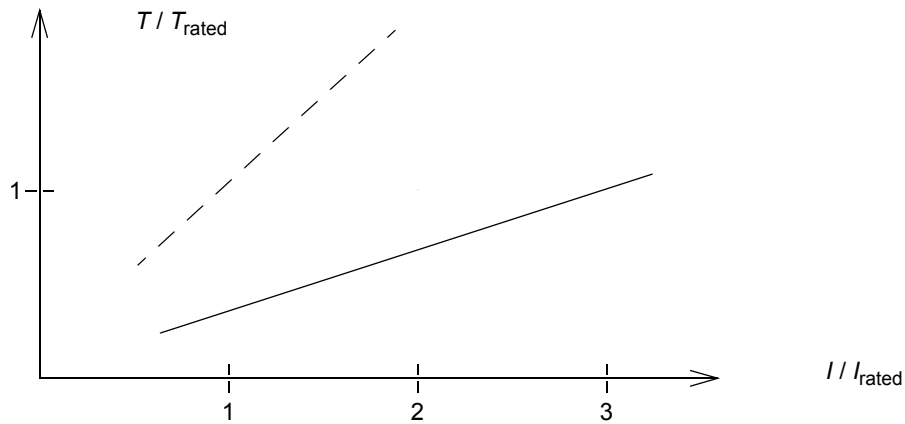

The current depends on the demand for starting torque. The magnetizing current of the motor equals

$$I_{\text{magn}} = \sqrt{1 - \cos^2(\varphi_n)} \cdot I_n$$

The torque-producing current equals

$$I_{\text{torq}} = \frac{T_{\text{ref}}}{100} \cdot \cos(\varphi_n) \cdot I_n$$

Resistive losses consist of transformer, cable and motor stator resistance. Thus, the voltage drop at the required current equals

$$U_{\text{drop,phase}} = I_2 \cdot (R_k + R_c + R_s)$$

where

$$I_2 = \sqrt{I_{\text{magn}}^2 + I_{\text{torq}}^2}$$

The voltage drop of the drive output equals

$$U_{\text{drop,primary}} = \frac{U_1}{U_2} \cdot \sqrt{3} \cdot U_{\text{drop,phase}}$$

At frequency f , the normally required voltage equals

$$U_{U/F} = \frac{f}{f_n} \cdot U_{\text{input}}$$

Thus, the required boost equals

$$BOOST = \frac{U_{\text{drop,primary}} + U_{U/F}}{U_{U/F}} \cdot 100\%$$

The transformer is dimensioned according to the specified voltage boost.

Example

In this example, the voltage boost (BOOST) is calculated for a 50% torque. The motor data etc. are as above.

$$I_{\text{USED}} = \sqrt{(\sqrt{1 - 0,82^2} \cdot 106)^2 + \left(\frac{50}{100} \cdot 0,82 \cdot 106\right)^2} \text{ A} = 74,63 \text{ A}$$

The voltage drop on the secondary side equals (assumed motor stator resistance 0.3 ohm, assumed transformer resistance 0.19 ohm)

$$U_{\text{drop,phase}} = 74,63 \cdot (0,19 + 1,35 + 0,3) \text{ V} = 137.3 \text{ V}$$

On the primary side, the voltage drop equals

$$U_{\text{drop,primary}} = \frac{620}{3560} \cdot \sqrt{3} \cdot 137.3 \text{ V} = 41.4 \text{ V}$$

For 2 Hz, the normal U/F curve gives the following result:

$$U_{U/F} = \frac{2}{50} \cdot 690 \text{ V} = 27.6 \text{ V}$$

Thus, the required voltage boost for 50% equals

$$BOOST = \frac{41,4 + 27,6}{27,6} \cdot 100\% = 250\%$$

The transformer should, according to the above calculations, withstand 250% voltage at 2 Hz frequency. The calculated boost value is to be forwarded to the manufacturer of the transformer.

In practice, the voltage boost is achieved through IR compensation. In the example, the parameter 26.03 IR COMPENSATION should be set to 6% ($0.06 \times 690 \text{ V} = 41.4 \text{ V}$). IR compensation should start at approximately slip frequency in order to avoid transformer saturation. This can be achieved using parameter 26.04 IR STEP-UP FREQ.

To summarise the above,

- the voltage boost value is a specification for the manufacturer of the transformer. It defines how much the transformer is able to withstand overvoltage. The boost is scaled according to the U/F curve
- voltage boost is implemented using IR compensation, which is scaled according to the output voltage of the drive (690, 500 or 400 V).

Set parameter 26.03 IR COMPENSATION to the correct value (see the calculation above). Note that BOOST and IR compensation have different scalings. If the value is not known, use values starting from 0.5% (of nominal motor voltage).

Set parameter 26.04 IR STEP-UP FREQ to approximately

$$\frac{n_s - n_n}{n_s} \cdot f_n$$

where

$$n_s = \frac{60 \cdot f_n \cdot 2}{\text{pole number}} \quad n_n = \text{nominal motor speed in rpm}$$

Note: Instead of using the motor rating plate data, set parameter 99.05 MOTOR NOM VOLTAGE according to the nominal supply voltage of the drive (e.g. 690 V). Set parameter 99.06 MOTOR NOM CURRENT to

$$\frac{U_2}{U_1} \cdot I_n$$

where U1 and U2 are the primary and secondary voltages of the step-up transformer respectively.

Illustrations

What this chapter contains

This chapter contains dimensional drawings, circuit diagrams and installation examples of sine filters.

The dimensional drawings show the dimensions of the cabinets, drive and filter cubicles, and cable connection points and lead-throughs.

NSIN0006-5...NSIN0140-5, NSIN0011-7...NSIN0120-7

Dimensions

IP00

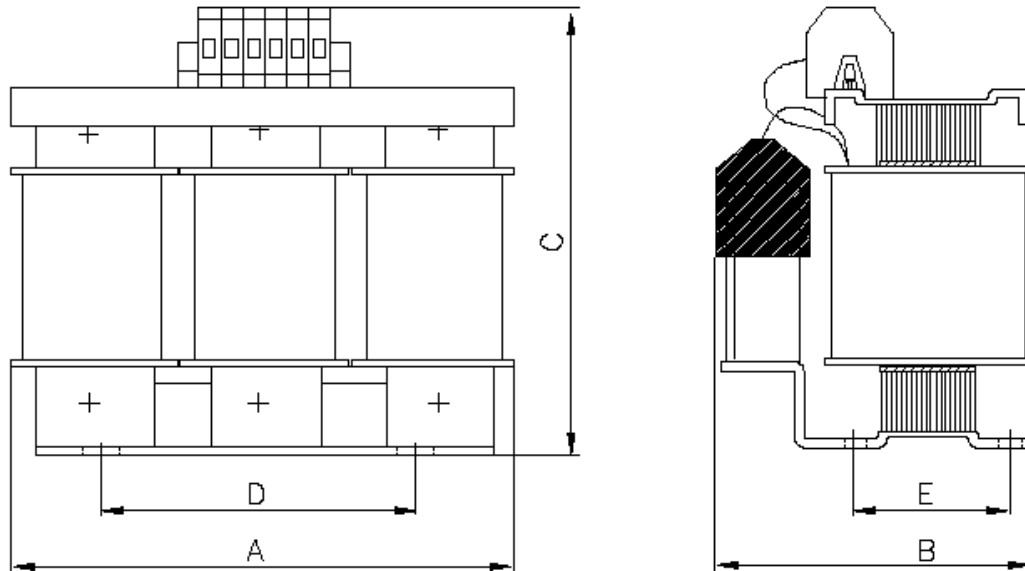

Filter type	Dimensions (mm)					Fixing	Weight (kg)
	A	B	C	D	E		
NSIN0006-5	155	120	160	130	71	M5	5.5
NSIN0016-5	240	190	280	190	105	M6	14.5
NSIN0020-5	240	200	280	190	105	M6	19
NSIN0025-5	240	210	280	190	115	M6	21
NSIN0030-5	240	220	280	190	125	M6	25.5
NSIN0040-5	300	228	315	240	133	M8	33.5
NSIN0050-5	300	240	315	240	145	M8	37
NSIN0060-5	300	270	320	240	172	M8	53
NSIN0070-5	360	210	415	264	125	M8	66
NSIN0100-5	360	225	415	264	140	M10	69
NSIN0120-5	360	240	415	264	154	M10	75
NSIN0140-5	400	500	450	320	450	M10	120
NSIN0011-7	240	200	280	190	105	M10	20
NSIN0020-7	240	220	280	190	125	M10	25.5
NSIN0025-7	300	235	320	240	133	M10	39
NSIN0040-7	300	247	320	240	145	M10	41.5
NSIN0060-7	300	275	330	240	171	M10	57
NSIN0070-7	360	240	415	264	138	M10	74.5
NSIN0120-7	420	290	500	316	173	M10	125.5

IP23

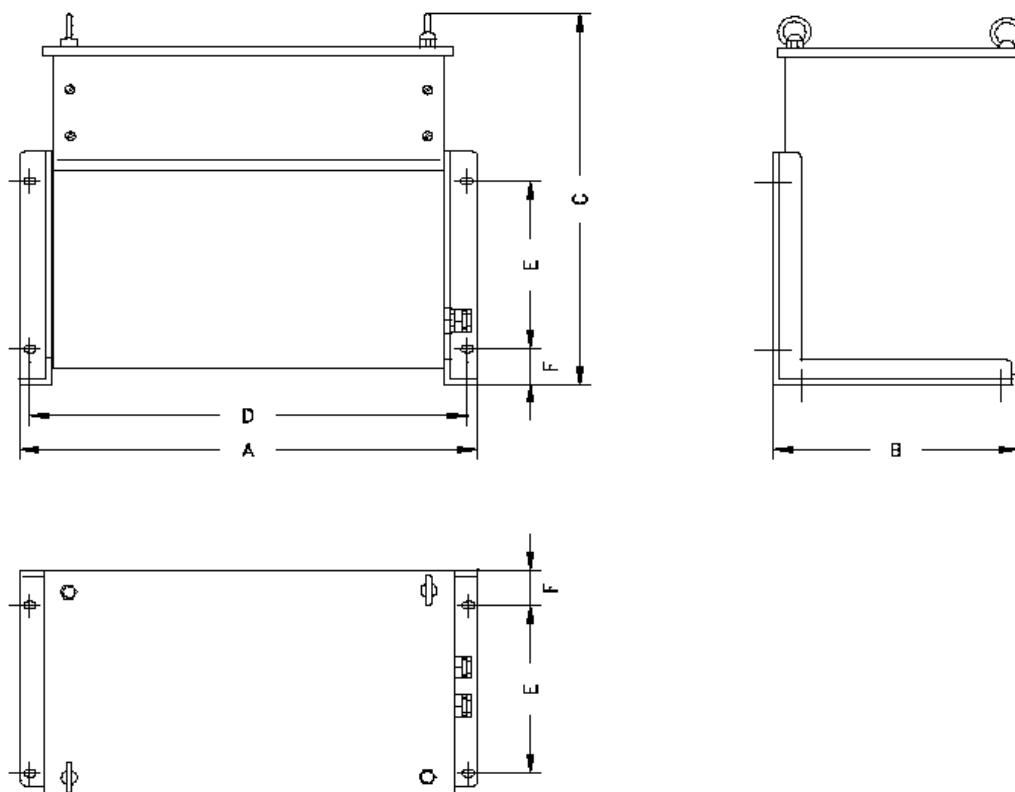

Filter type	Dimensions (mm)						Weight (kg)
	A	B	C	D	E	F	
NSIN0006-5	230	250	210	167	200	24	9.2
NSIN0016-5	470	270	460	446	200	40	25.5
NSIN0020-5	470	270	460	446	200	40	30
NSIN0025-5	470	270	460	446	200	40	32
NSIN0030-5	470	270	460	446	200	40	36.5
NSIN0040-5	470	270	460	446	200	40	44.5
NSIN0050-5	580	325	510	550	255	40	53
NSIN0060-5	580	325	510	550	255	40	69
NSIN0070-5	580	325	510	550	255	40	82
NSIN0100-5	580	325	510	550	255	40	85
NSIN0120-5	700	425	620	660	325	40	105
NSIN0140-5	700	525	620	660	425	40	165
NSIN0011-7	470	270	460	446	200	40	31
NSIN0020-7	470	270	460	446	200	40	36.5
NSIN0025-7	580	325	510	550	255	40	55
NSIN0040-7	580	325	510	550	255	40	57.5
NSIN0060-7	580	325	510	550	255	40	73
NSIN0070-7	580	325	510	550	255	40	90.5
NSIN0120-7	580	325	510	550	255	40	141.5

Photographs

IP00 (example)

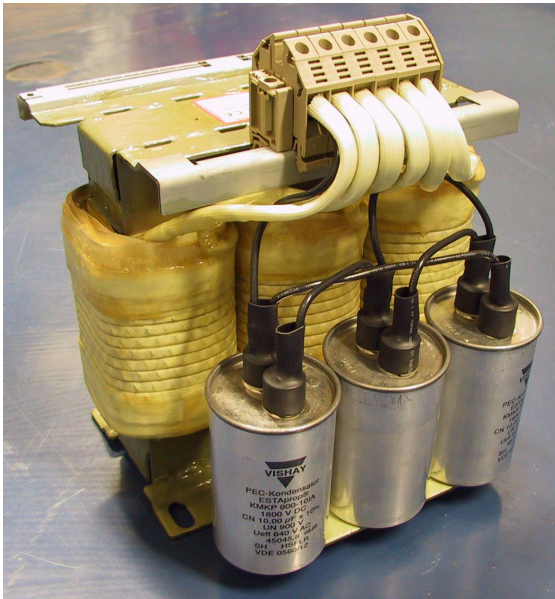

IP23 (example)



IP23, cover removed (example)

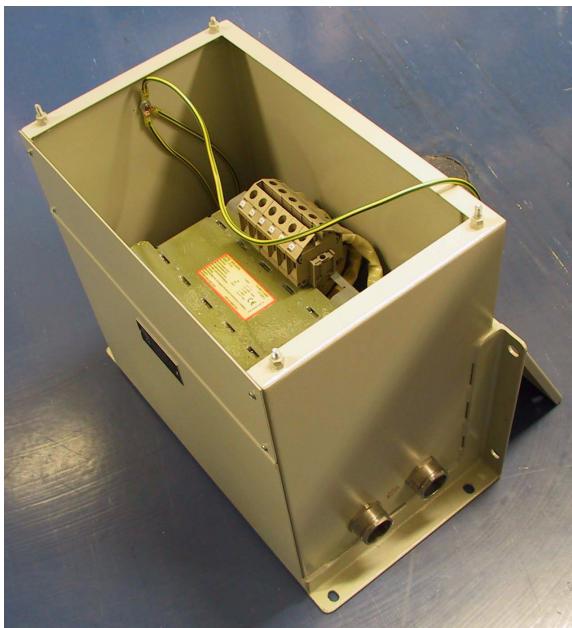

NSIN0210-6, NSIN0315-6, NSIN0485-6 for ACS800-02/04

Circuit diagram

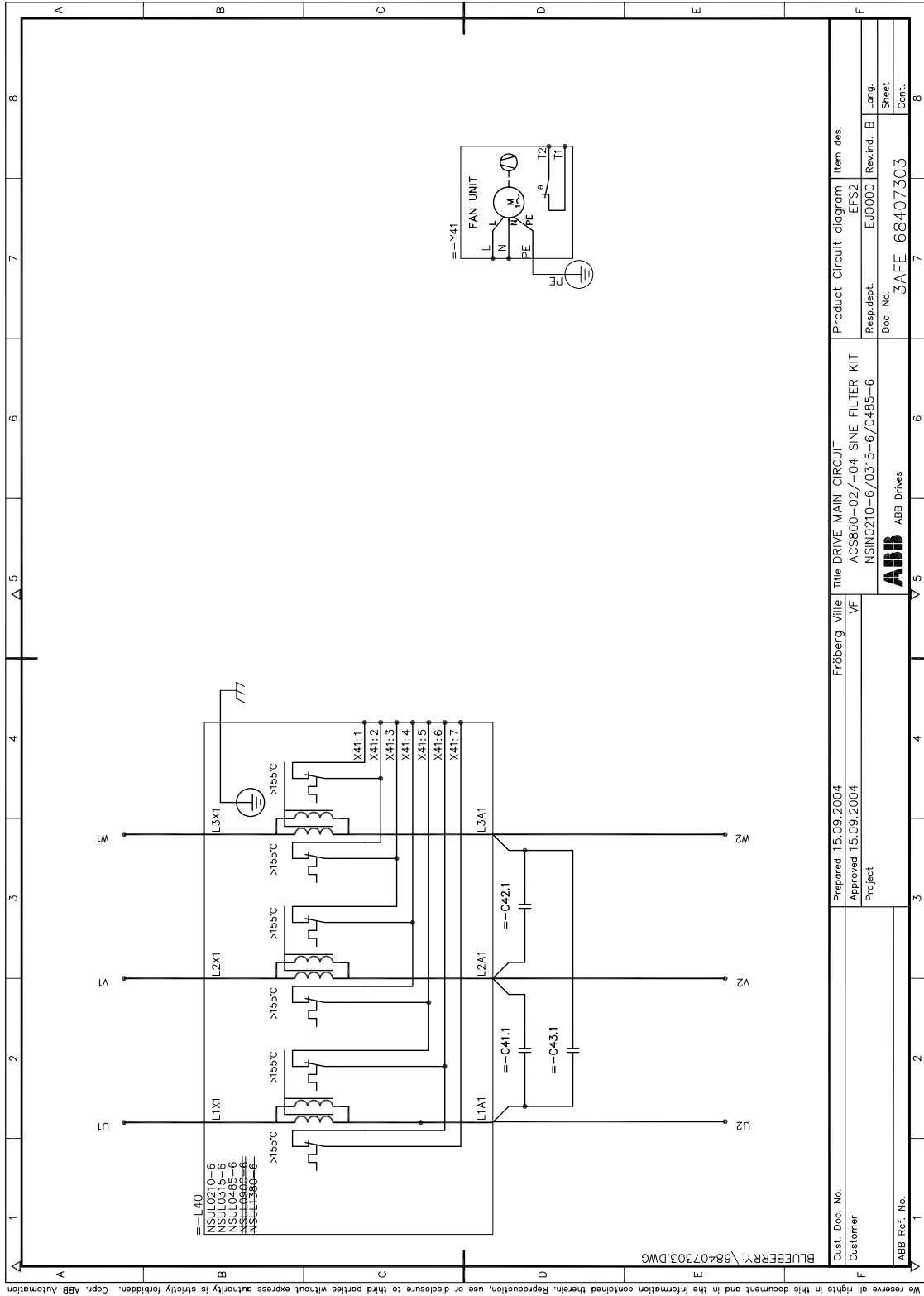

Dimensional drawing – choke module

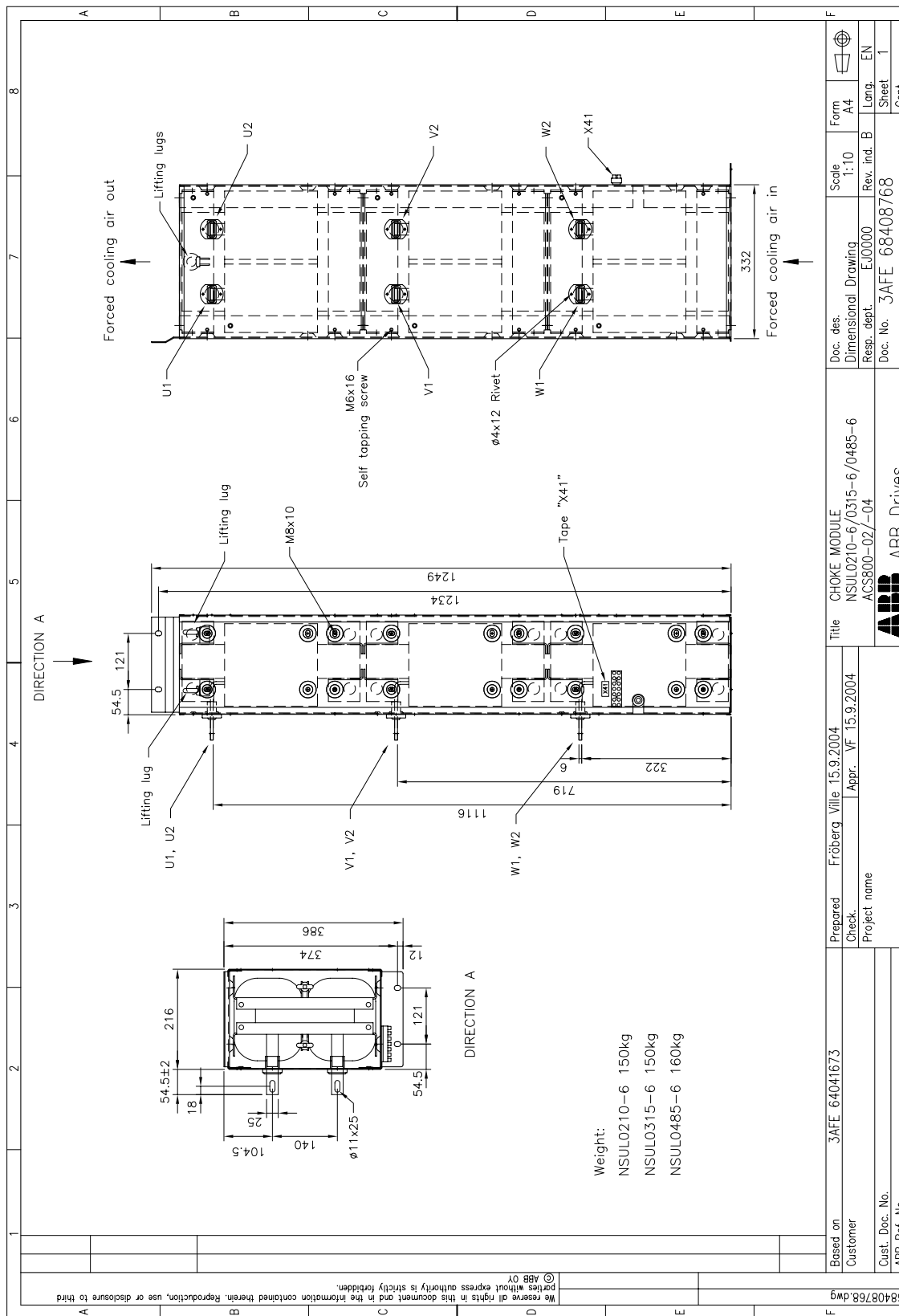

Installation example

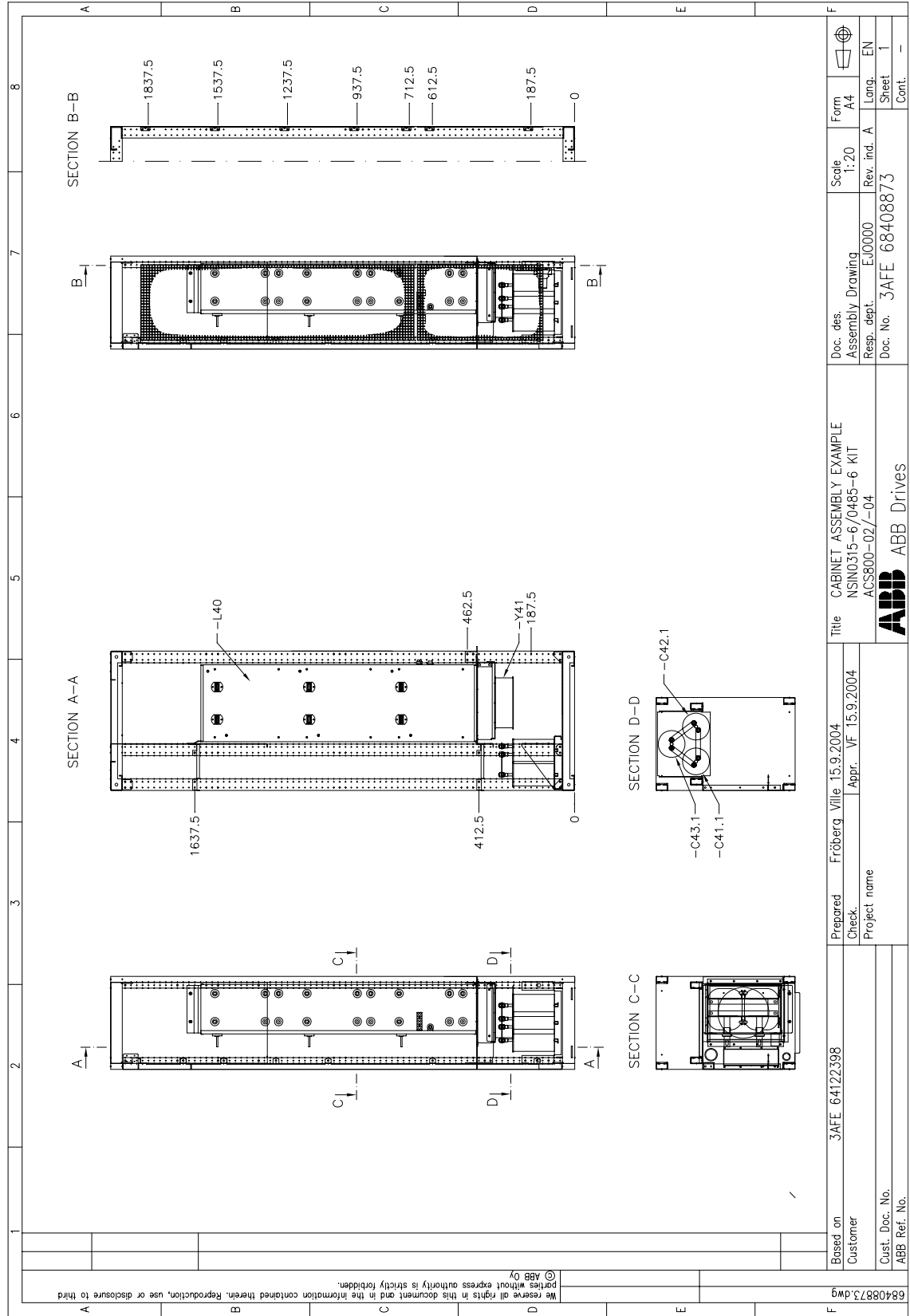

68408873.dwg
 © ABB Oy
 We reserve all rights in this document and in the information contained therein. Reproduction, use or disclosure to third parties without express authority is strictly forbidden.

Based on	3AFE 64122398	Prepared	Fröberg Vile 15.9.2004	Title	CABINET ASSEMBLY EXAMPLE	Doc. des.	Assembly Drawing	Scale	1:20	Form	A4
Customer		Check.	Appr. VF 15.9.2004		NSIN0315-6/0485-6 KIT	Resp. dept.	EJ0000	Rev. ind.	A	Long.	EN
Cust. Doc. No.		Project name			ACS800-02/-04	Doc. No.	3AFE 68408873			Sheet	1
ABB Ref. No.					ABB ABB Drives					Cont.	-

(continued)

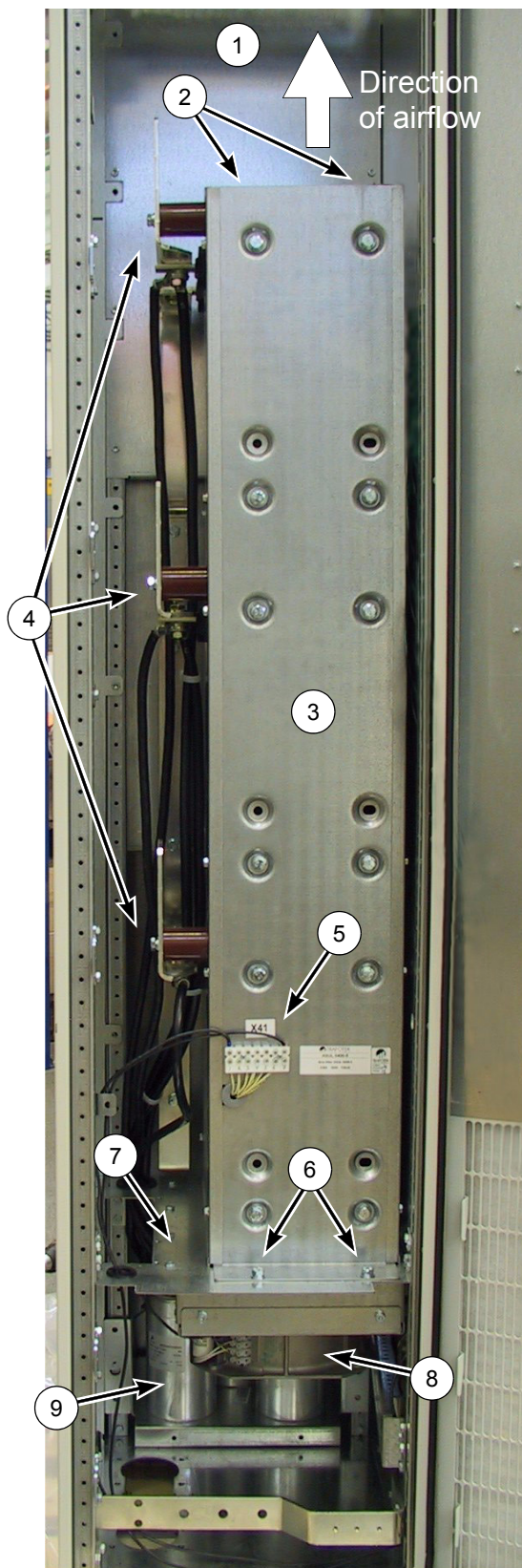

No.	Description
1	Vertical support plate
2	Upper fixing points (obscured)
3	Choke module
4	Terminals
5	Temperature supervision wiring
6	Lower fixing points
7	Horizontal support plate/air baffle
8	Cooling fan
9	Capacitors

NSIN0900-6, NSIN1380-6 for ACS800-02/04

Circuit diagram

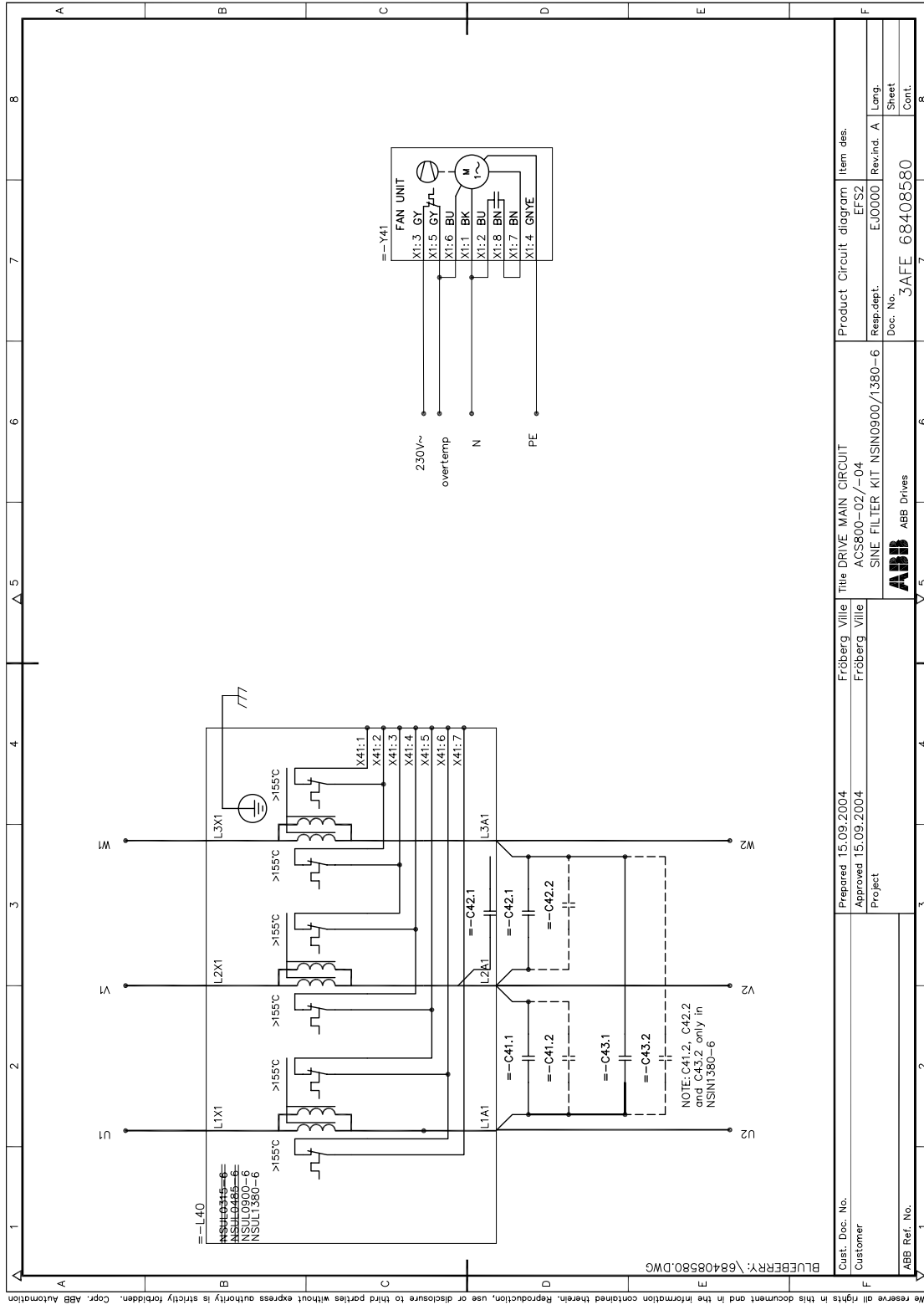

We reserve all rights in this document and in the information contained therein. Reproduction, use or disclosure to third parties without express authority is strictly forbidden. Copr. ABB Automation

1	Customer	Prepared 15.09.2004 Approved 15.09.2004 Project	Fröberg Ville Fröberg Ville	Title DRIVE MAIN CIRCUIT ACS800-02/-04 SINE FILTER KIT NSIN0900/1380-6	Product Circuit diagram EFSZ	Item des. EJ0000
2	ABB Ref. No.				Resp.dept. EJ0000	Rev.ind. A
3					Doc. No. 3AFE 68408580	Sheet Cont.
4						8
5						7
6						6
7						5
8						4
9						3
10						2
11						1

Cooling fan wiring

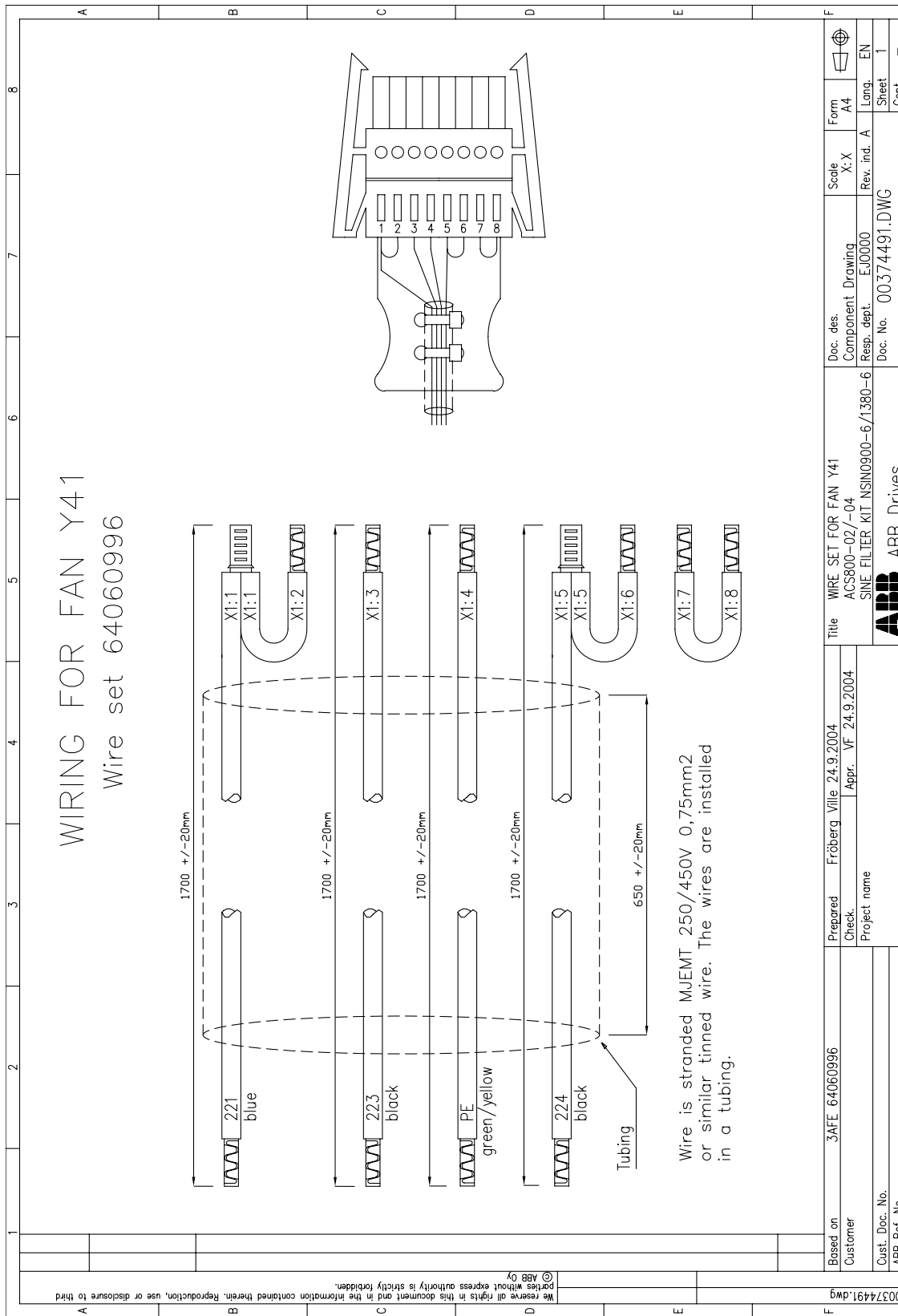

Wire is stranded MJEMT 250/450V 0,75mm² or similar tinned wire. The wires are installed in a tubing.

Dimensional drawing – choke module (NSIN0900-6)

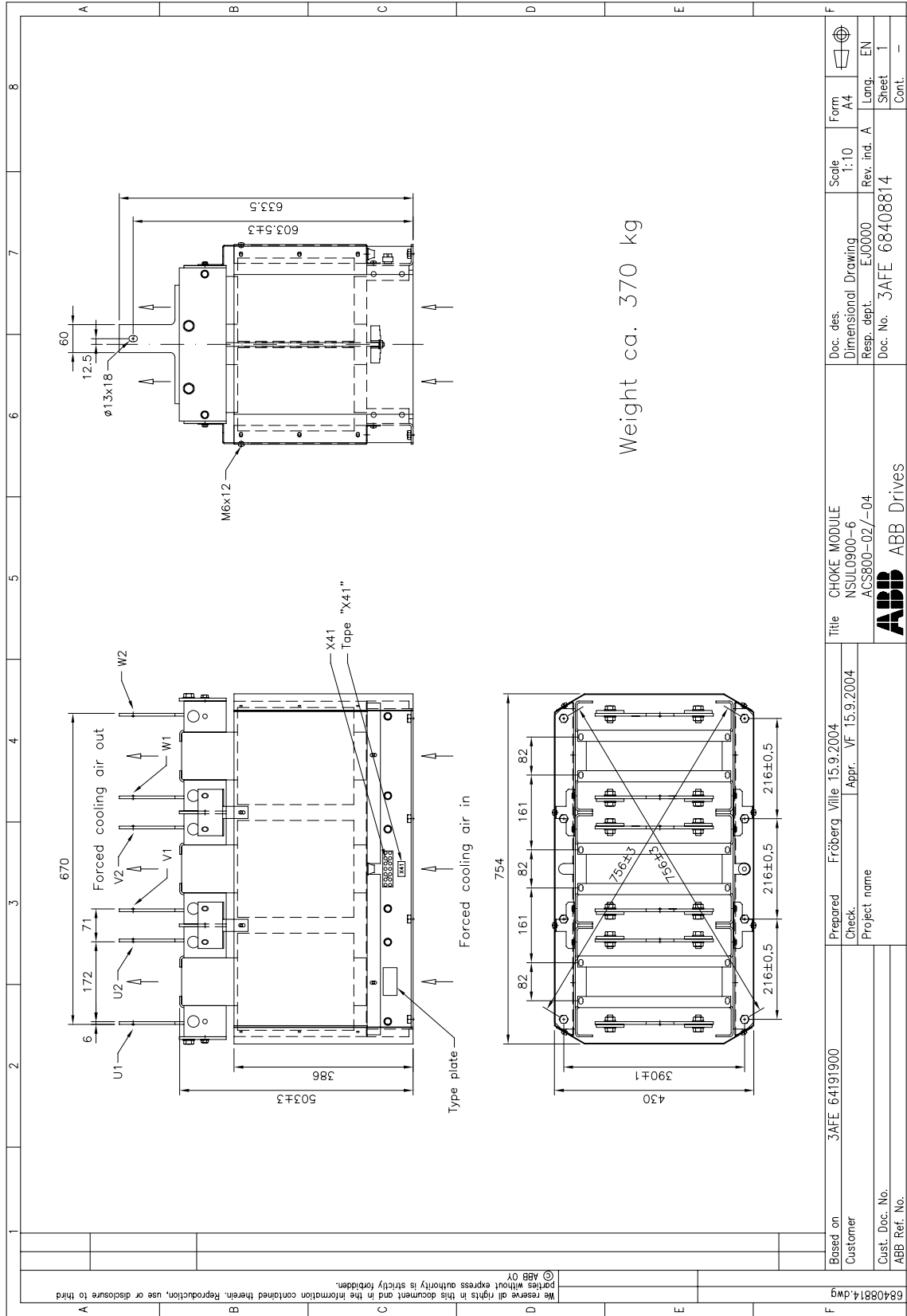

Dimensional drawing – choke module (NSIN1380-6)

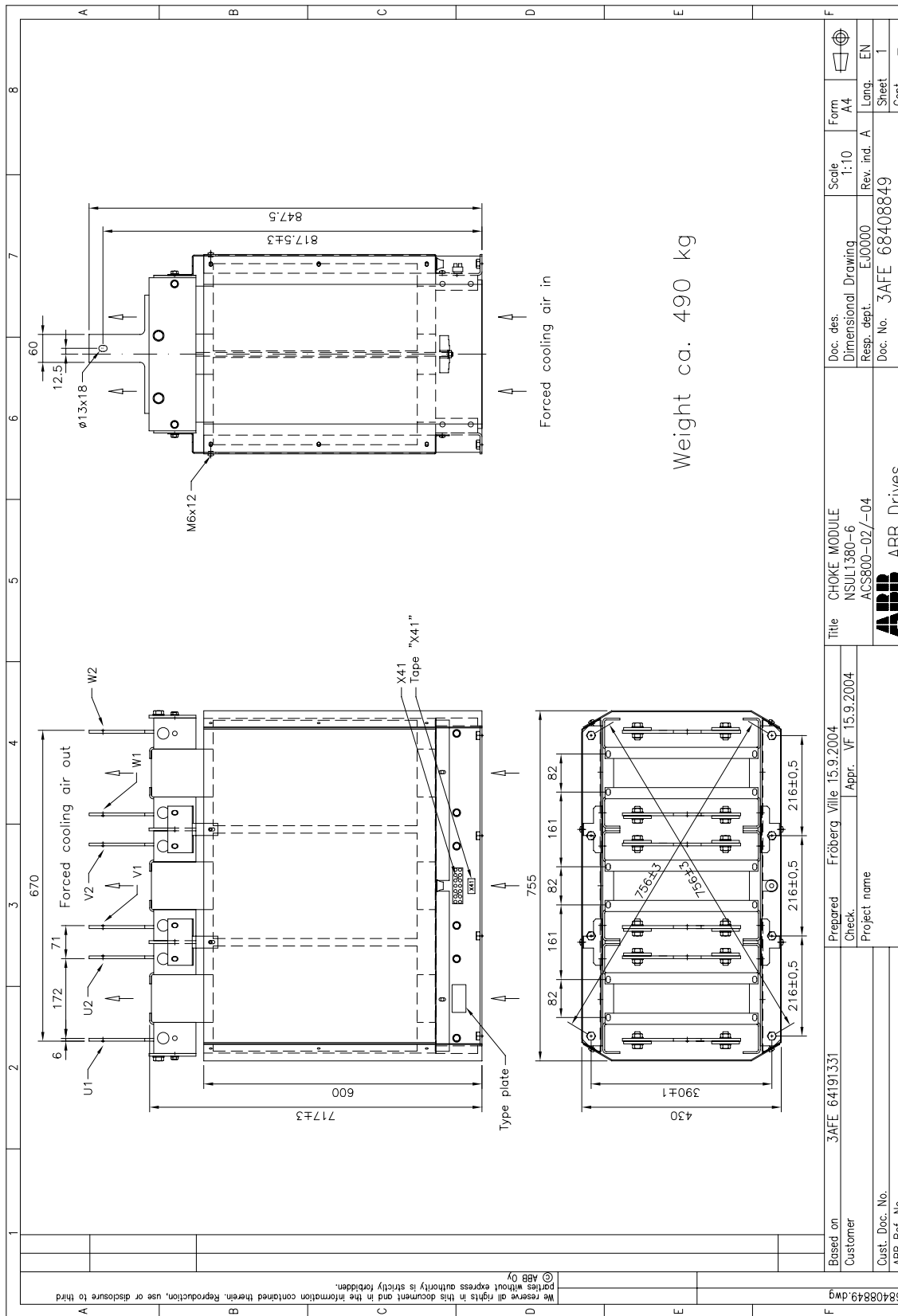

Weight ca. 490 kg

68408849.dwg	© ABB Oy We reserve all rights in this document and in the information contained therein. Reproduction, use or disclosure to third parties without express authority in the information is strictly forbidden.		Based on Customer	3AFE 64191331	Prepared Check.	Fröberg Ville 15.9.2004 Appr. VF 15.9.2004	Title CHOKE MODULE NSUL1380-6 ACS800-02/-04	Doc. des. Dimensional Drawing	Scale 1:10	Form A4	Sheet 1	Cont.
			Cust. Doc. No. ABB Ref. No.		Project name		Doc. No. 3AFE 68408849	Resp. dept. E00000	Rev. ind. A	Lang. EN	Sheet 1	Cont.
							ABB ABB Drives					

Installation example (NSIN0900-6)

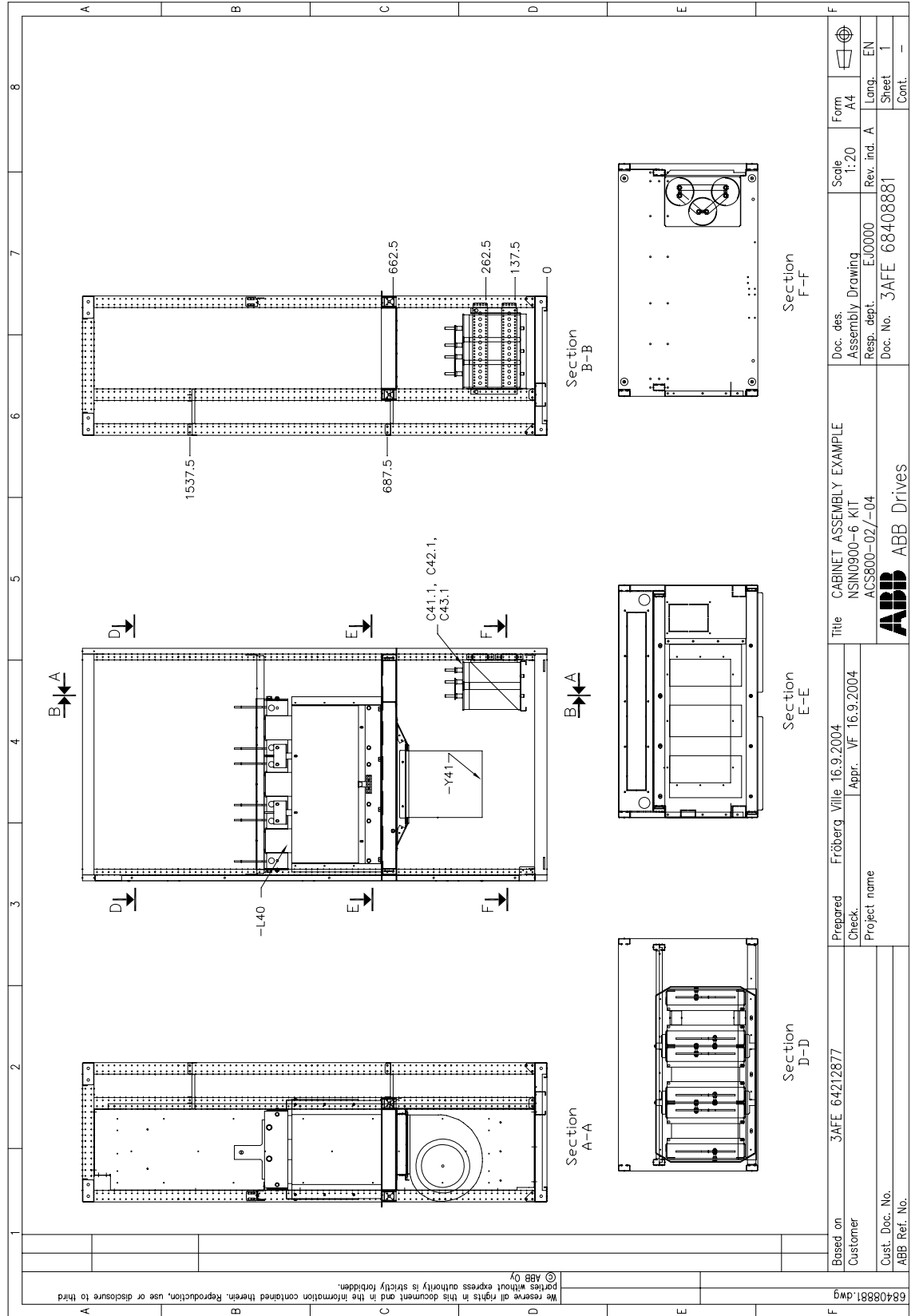

68408881.dwg
 © ABB Oy
 We reserve all rights in this document and in the information contained therein. Reproduction, use or disclosure to third parties without express authority is strictly forbidden.

Based on	3AFE 64212877	Prepared	Fröberg Ville 16.9.2004	Title	CABINET ASSEMBLY EXAMPLE	Doc. des.	Assembly Drawing	Form	A4	Scale	1:20
Customer		Check.	Appr. VF 16.9.2004		NSIN0900-6 KIT	Resp. dept.	EJ0000	Rev. ind.	A	Long.	EN
Cust. Doc. No.		Project name			ACS800-02/-04	Doc. No.	3AFE 68408881	Sheet	1	Cont.	-
ABB Ref. No.											

(continued)

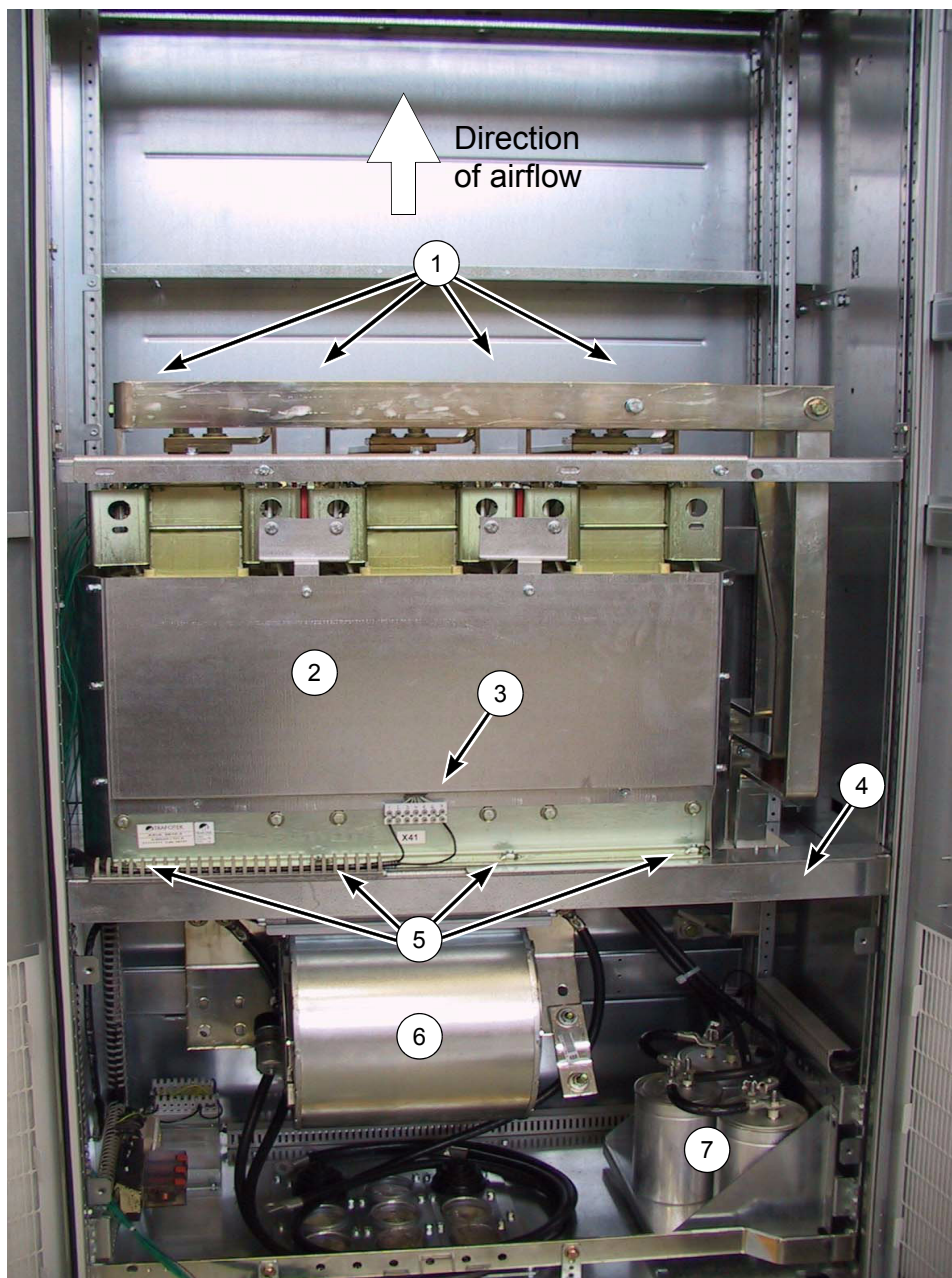

No.	Description
1	Terminals
2	Choke module
3	Temperature supervision wiring
4	Horizontal support plate/air baffle

No.	Description
5	Fixing points
6	Cooling fan
7	Capacitors

Installation example (NSIN1380-6)

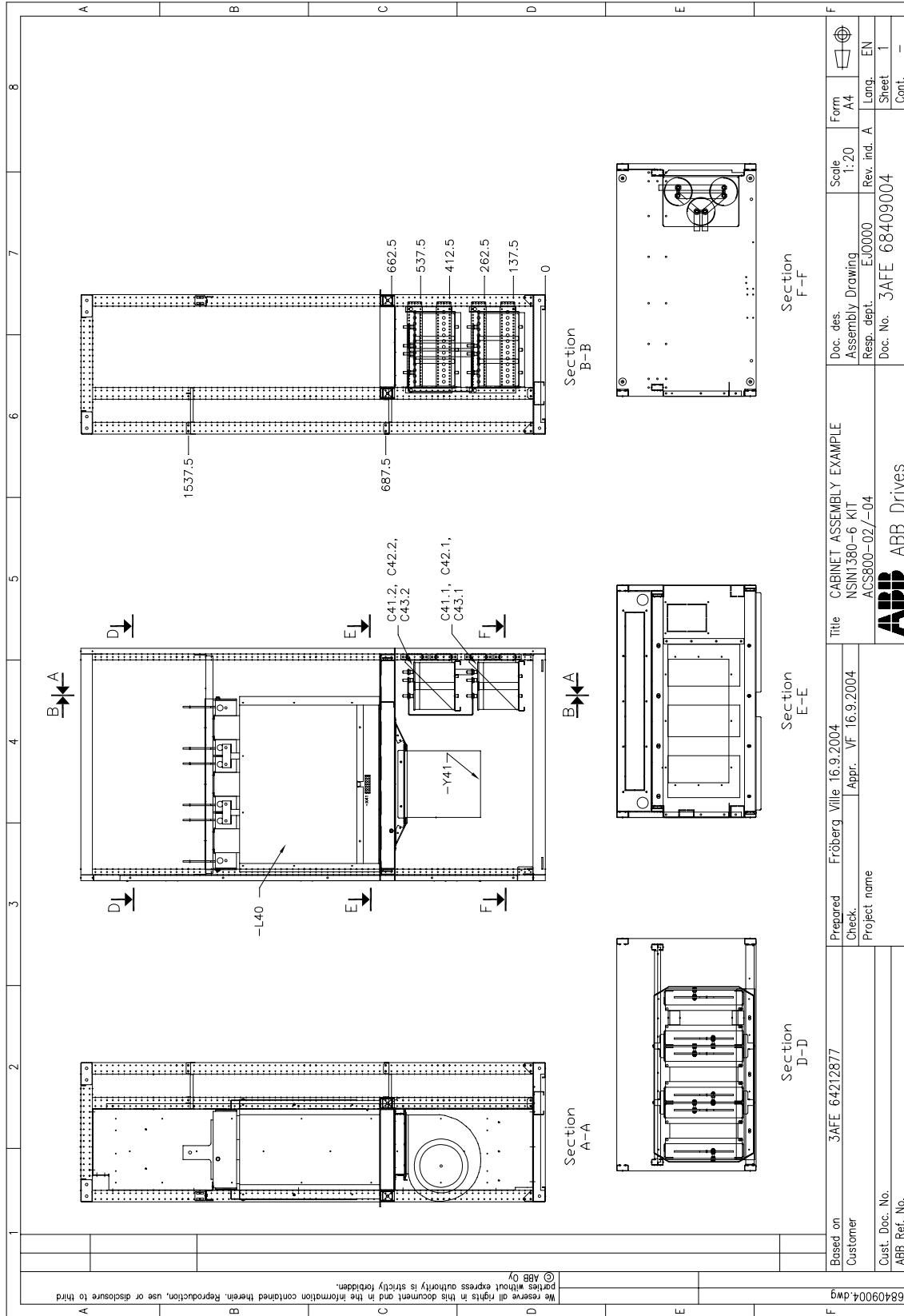

68409004.dwg
 © ABB by
 We reserve all rights in this document and in the information contained therein. Reproduction, use or disclosure to third parties without express authority is strictly forbidden.

Based on	SAFE 64212877	Prepared	Fröberg Ville 16.9.2004	Title	CABINET ASSEMBLY EXAMPLE	Doc. des.	Assembly Drawing	Scale	1:20	Form	A4
Customer		Check.	Appr. VF 16.9.2004		NSIN1380-6 KIT	Resp. dept.	EJ0000	Rev. ind.	A	Lana.	EN
Cust. Doc. No.		Project name			ACS800-02/-04	Doc. No.	SAFE 68409004			Sheet	1
ABB Ref. No.					ABB ABB Drives					Cont.	-

ACS800-07 with NSIN0210-6 or NSIN0315-6

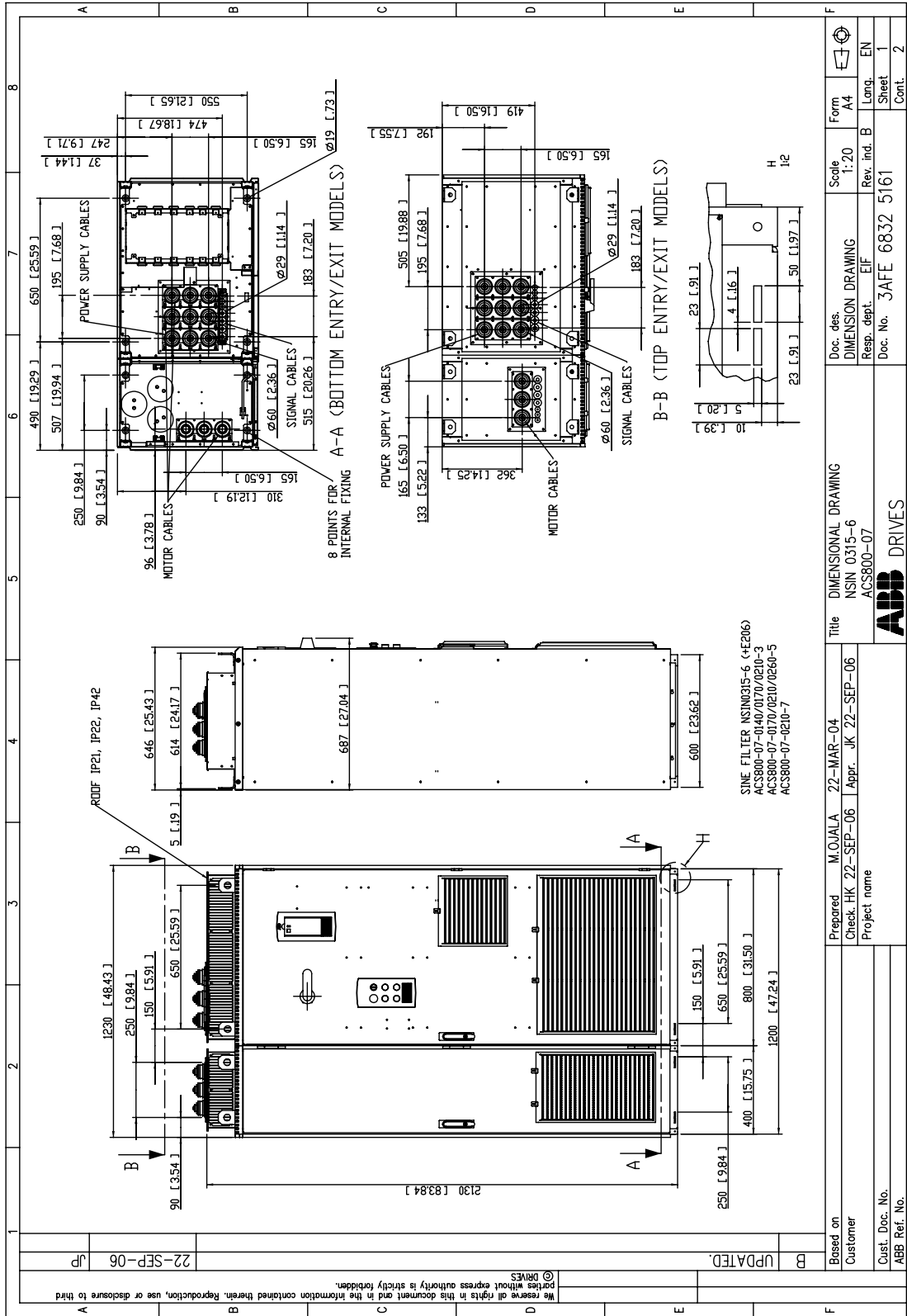

Based on	Customer	Prepared	M.OJALA	22-MAR-04	Title	DIMENSIONAL DRAWING	Doc. des.	DIMENSIONAL DRAWING	Scale	1:20	Form	A4	
Customer		Check	HK	22-SEP-06	Appr.	JK	22-SEP-06	Res. dept.	EIF	Rev. ind.	B	Lang.	EN
Cust. Doc. No.		Project name						Doc. No.	3AFE 6832 5161	Sheet	1	Cont.	2
ABB Ref. No.													

Note: NSIN0315-6 filter depicted. Dimensions also applicable to NSIN0210-6.

(continued)

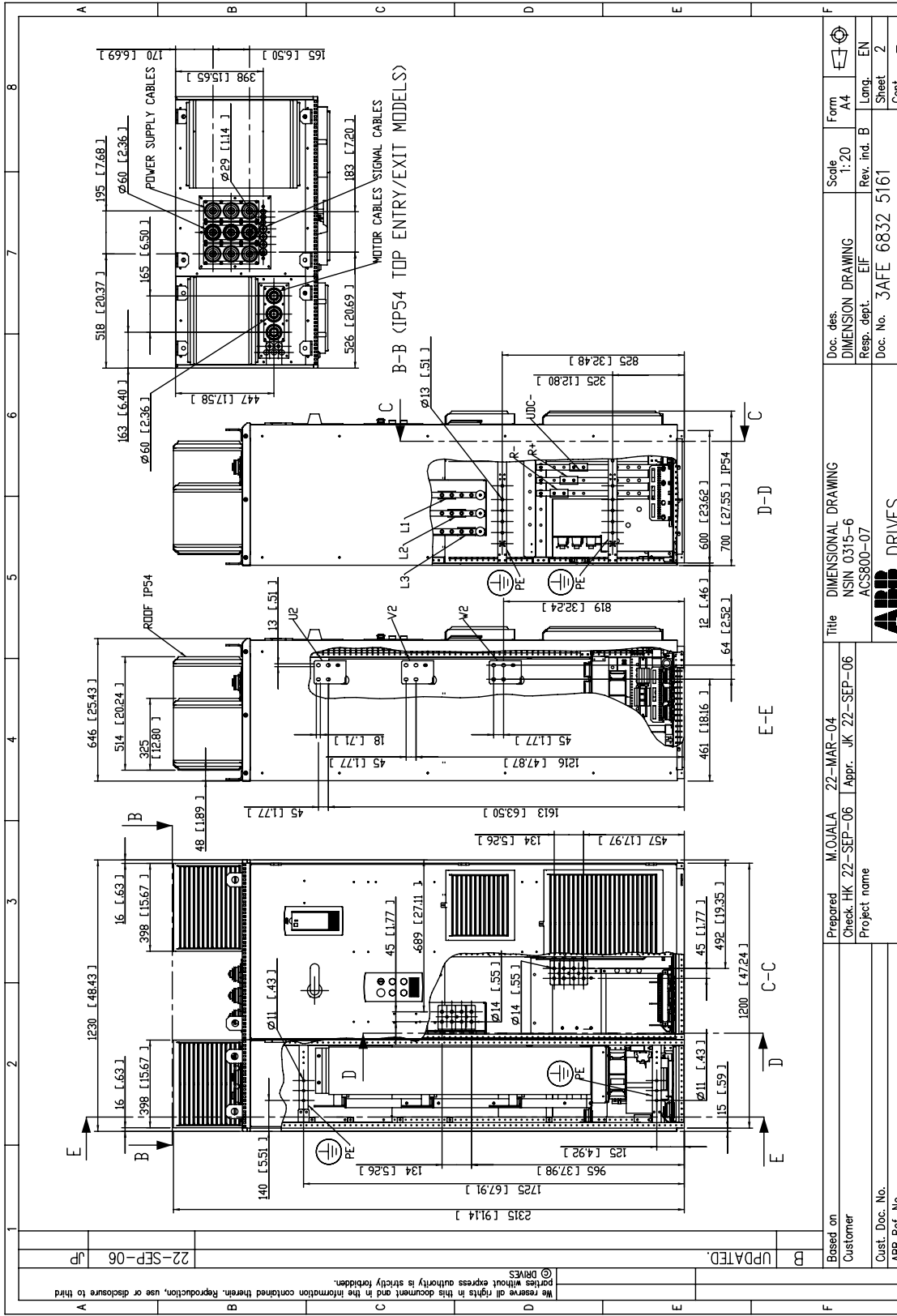

Based on Customer	Prepared M.OUALA 22-MAR-04	Title DIMENSIONAL DRAWING	Doc. des. DIMENSION DRAWING	Scale 1:20	Form A4
Cust. Doc. No. ABB Ref. No.	Check HK 22-SEP-06	NSIN 0315-6	Resp. dept. EIF	Rev. ind. B	Long. EN
	Project name	ACS800-07	Doc. No. 3AFE 6832 5161		Sheet 2
		ABB DRIVES			Cont. —

Note: NSIN0315-6 filter depicted. Dimensions also applicable to NSIN0210-6.

ACS800-07 with NSIN0315-6 and EMC filter +E202

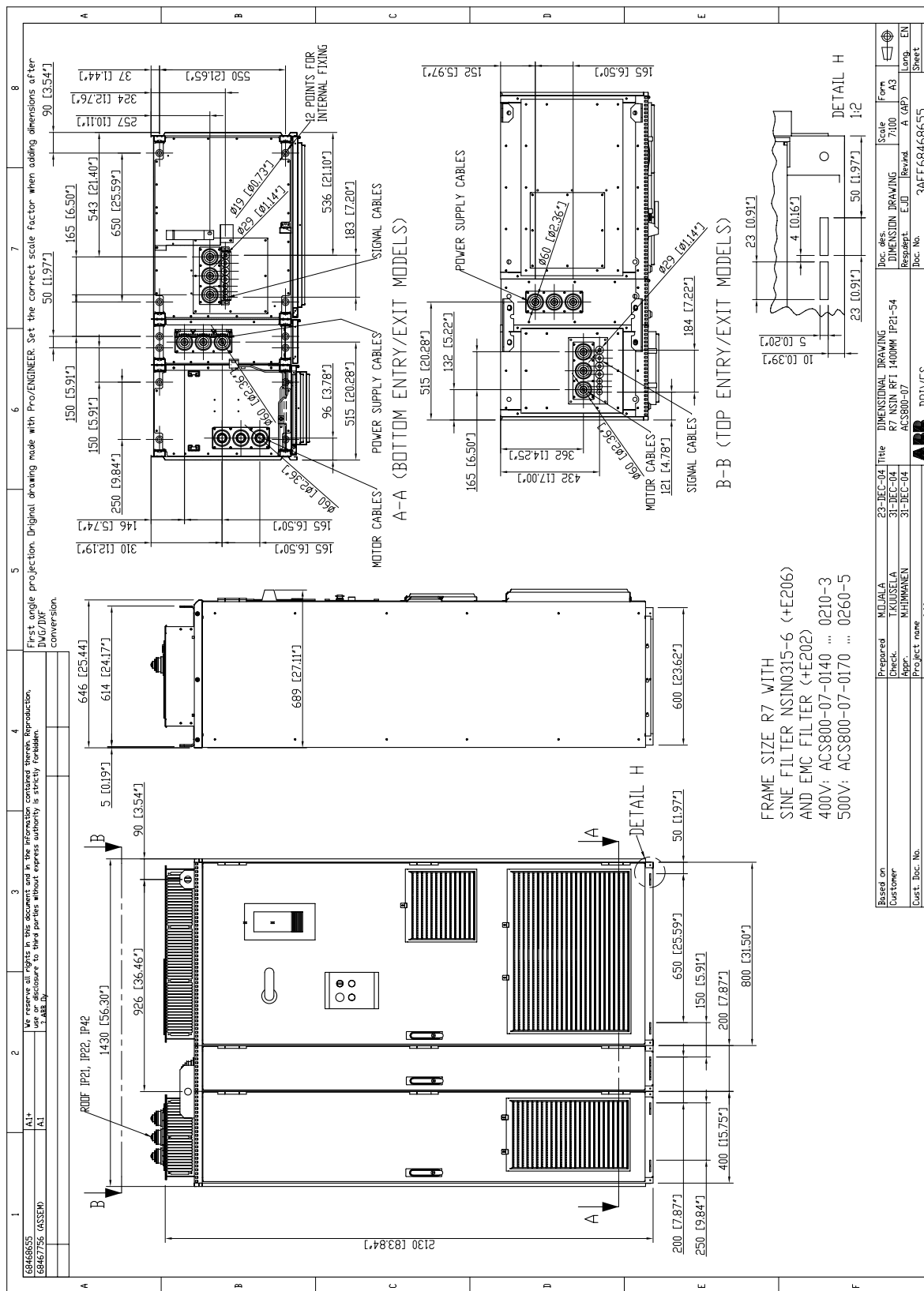

(continued)

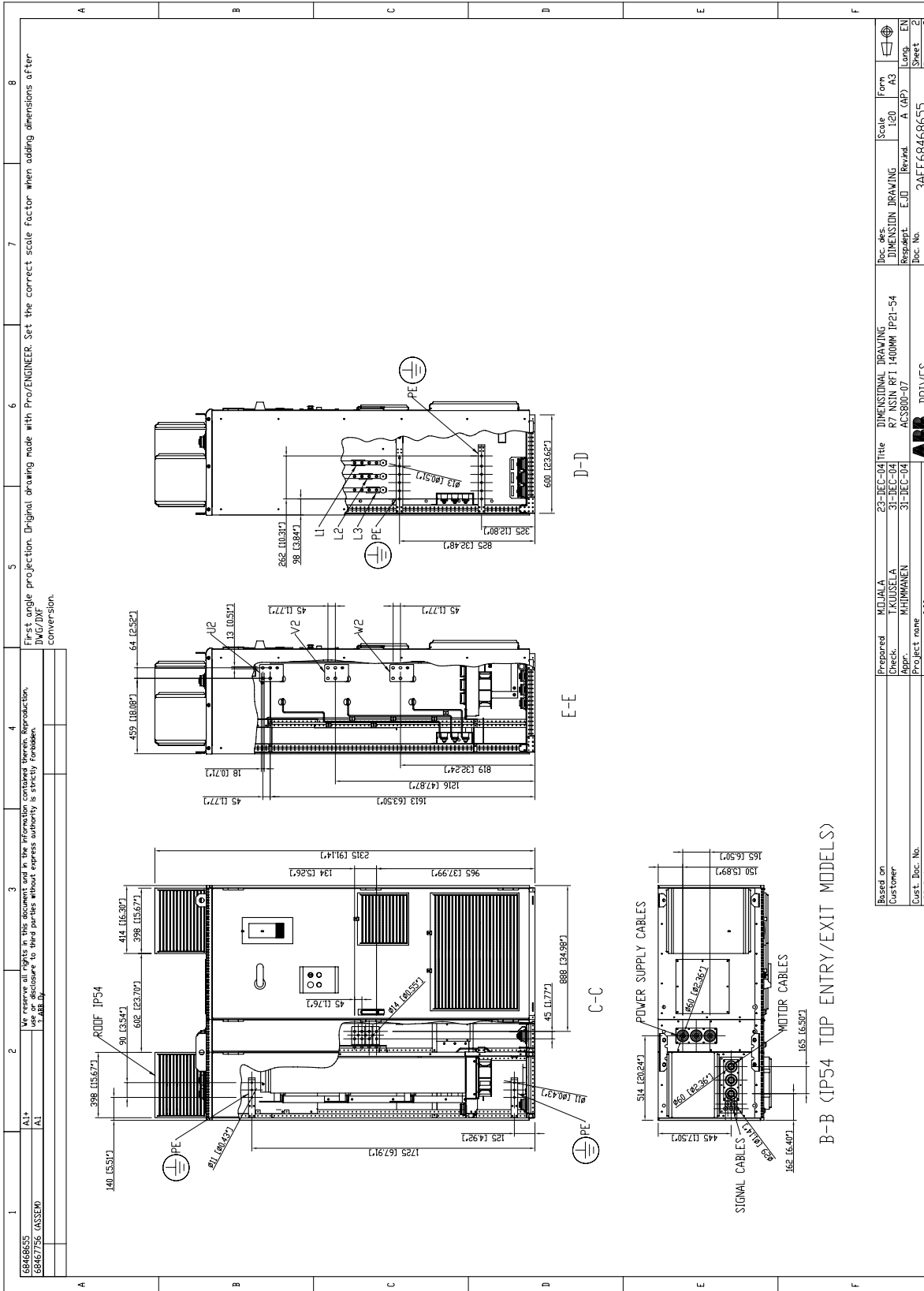

ACS800-07 with NSIN0485-6

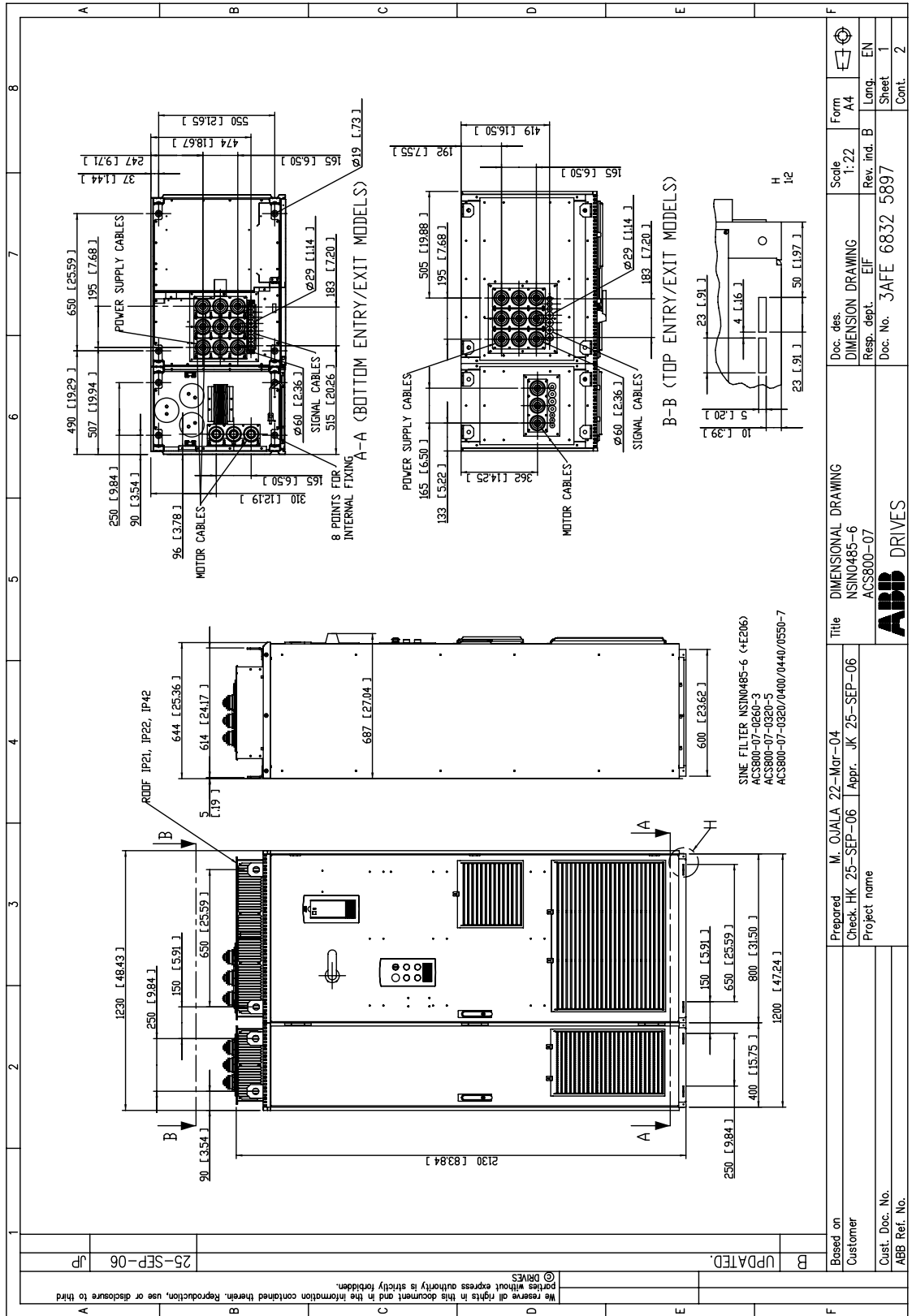

(continued)

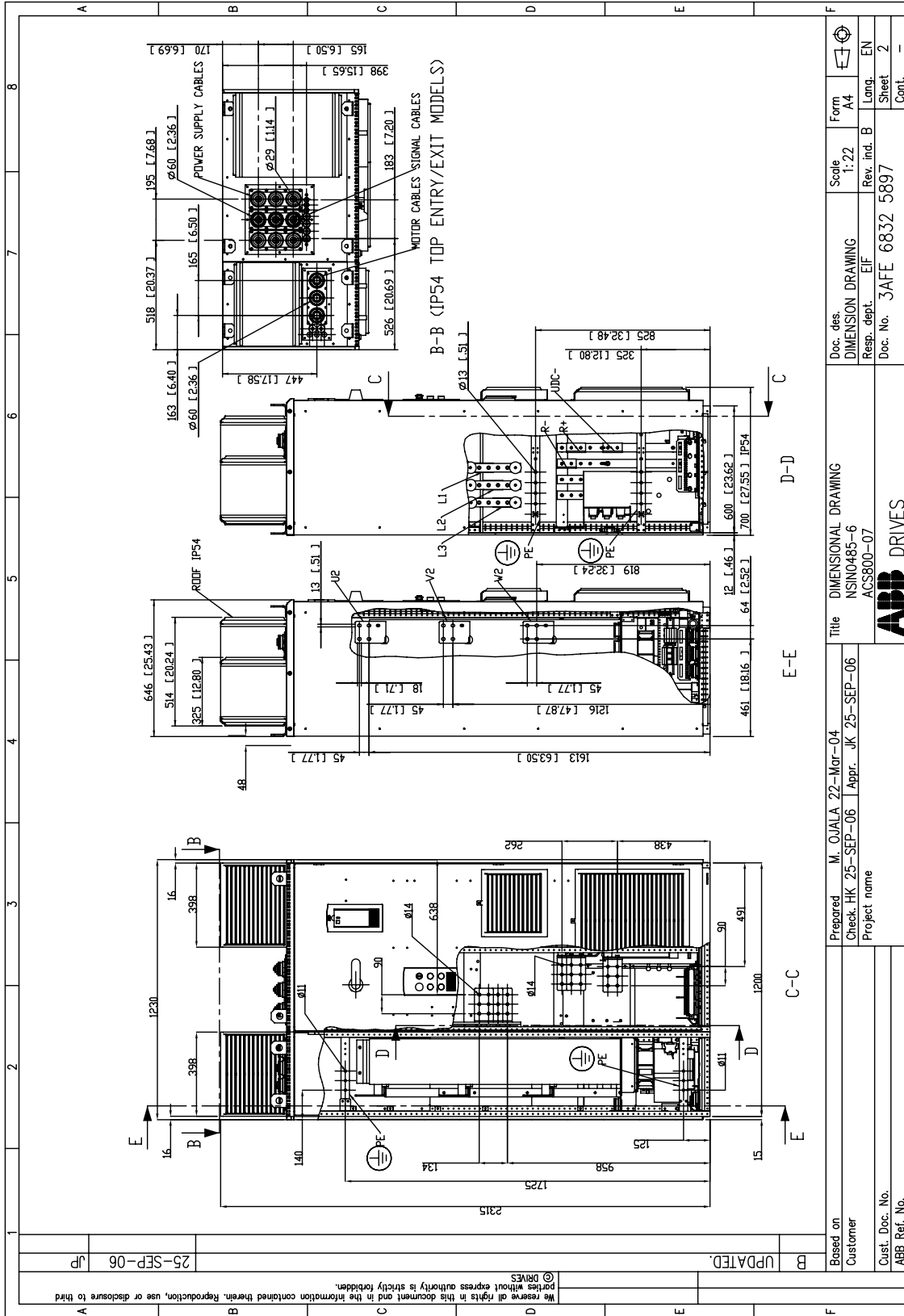

We reserve all rights in this document and in the information contained therein. Reproduction, use or disclosure to third parties without express authority is strictly forbidden.
© DMYS

UPDATED.

25-SEP-06
JP

Based on	Prepared	M. OJALA 22-Mar-04	Title	DIMENSIONAL DRAWING	Doc. des.	Scale	Form
Customer	Check	HK 25-SEP-06	NSIND485-6	DIMENSIONAL DRAWING	Res. dept.	1:22	A4
Cust. Doc. No.	Project name	Appr. JK 25-SEP-06	ACS800-07	EIF	Doc. No.	Rev. ind. B	Lamg. EN
ABB Ref. No.			ABB DRIVES		3AFE 6832 5897	Sheet	2
						Cont.	-

(continued)

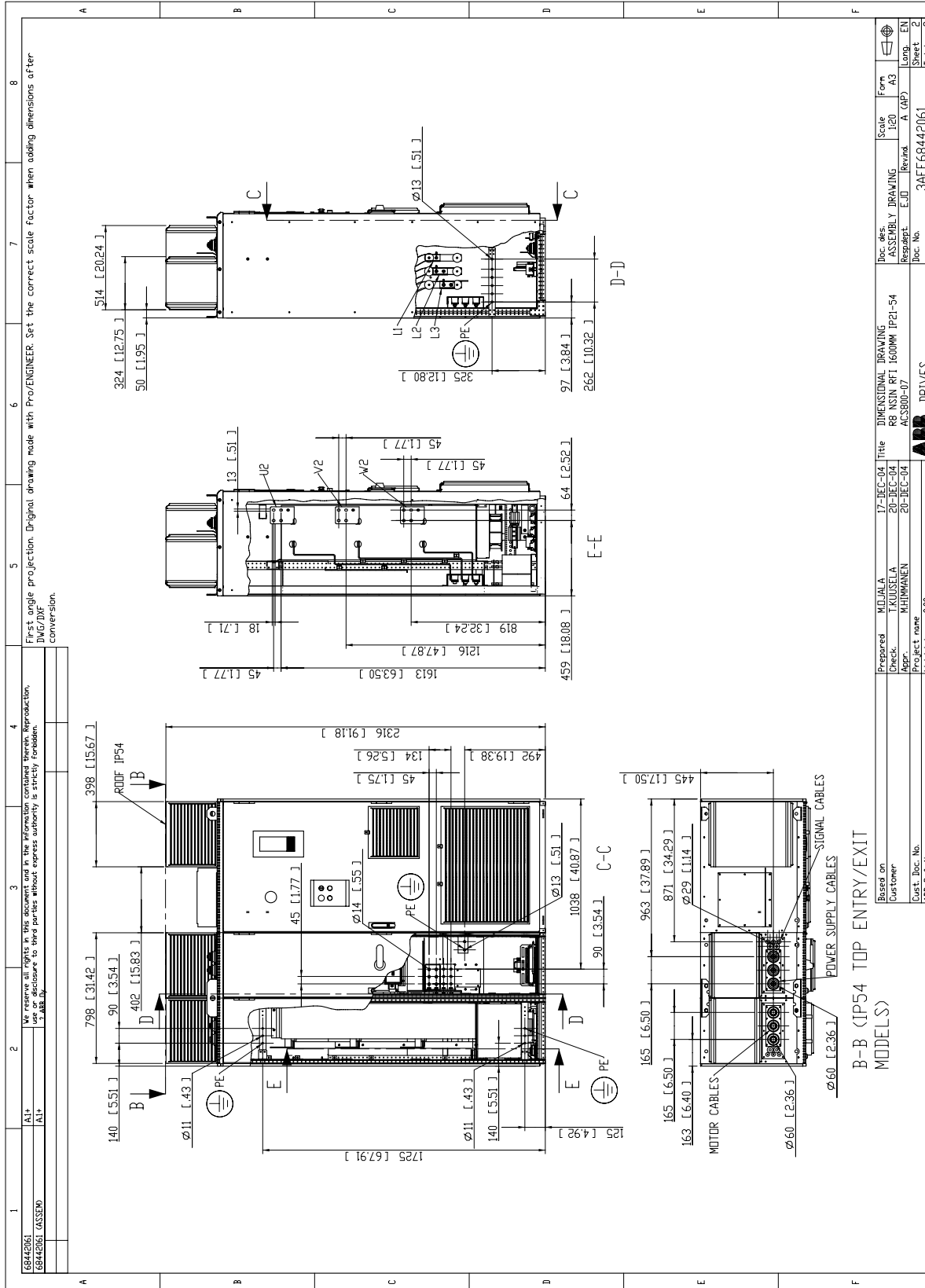

B-B (IP54 TOP ENTRY/EXIT MODELS)

Prepared	MILJALA	17-BEC-04	Title	DIMENSIONAL DRAWING	Doc. des.	ASSEMBLY DRAWING	Scale	1:20	Form	A3
Check	KUUSILA	20-BEC-04		R8 NSIN RPT 1600MM IP21-54	Regulablt.	EJD	Revised	A (AFP)		
Appr.	KHIMMANEN	20-BEC-04		ACS800-07	Doc. No.	3AFE68442061				
Project name	ABB DRIVES									
Weight kg	0.00									
Sheet	2									
Total	2									

ACS800-07 with NSIN0900-6 or NSIN1380-6

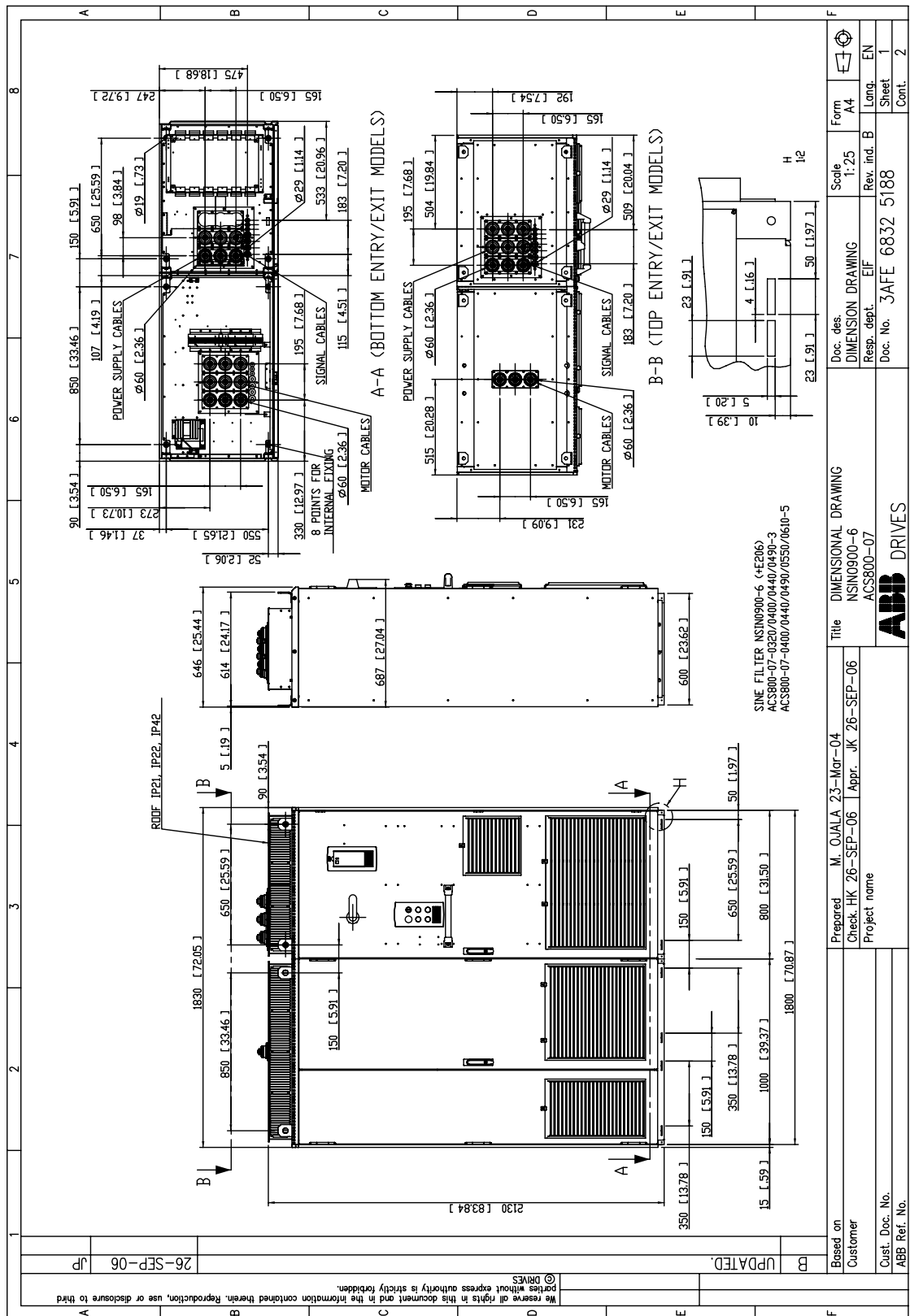

Note: NSIN0900-6 filter depicted. Dimensions also applicable to NSIN1380-6.

(continued)

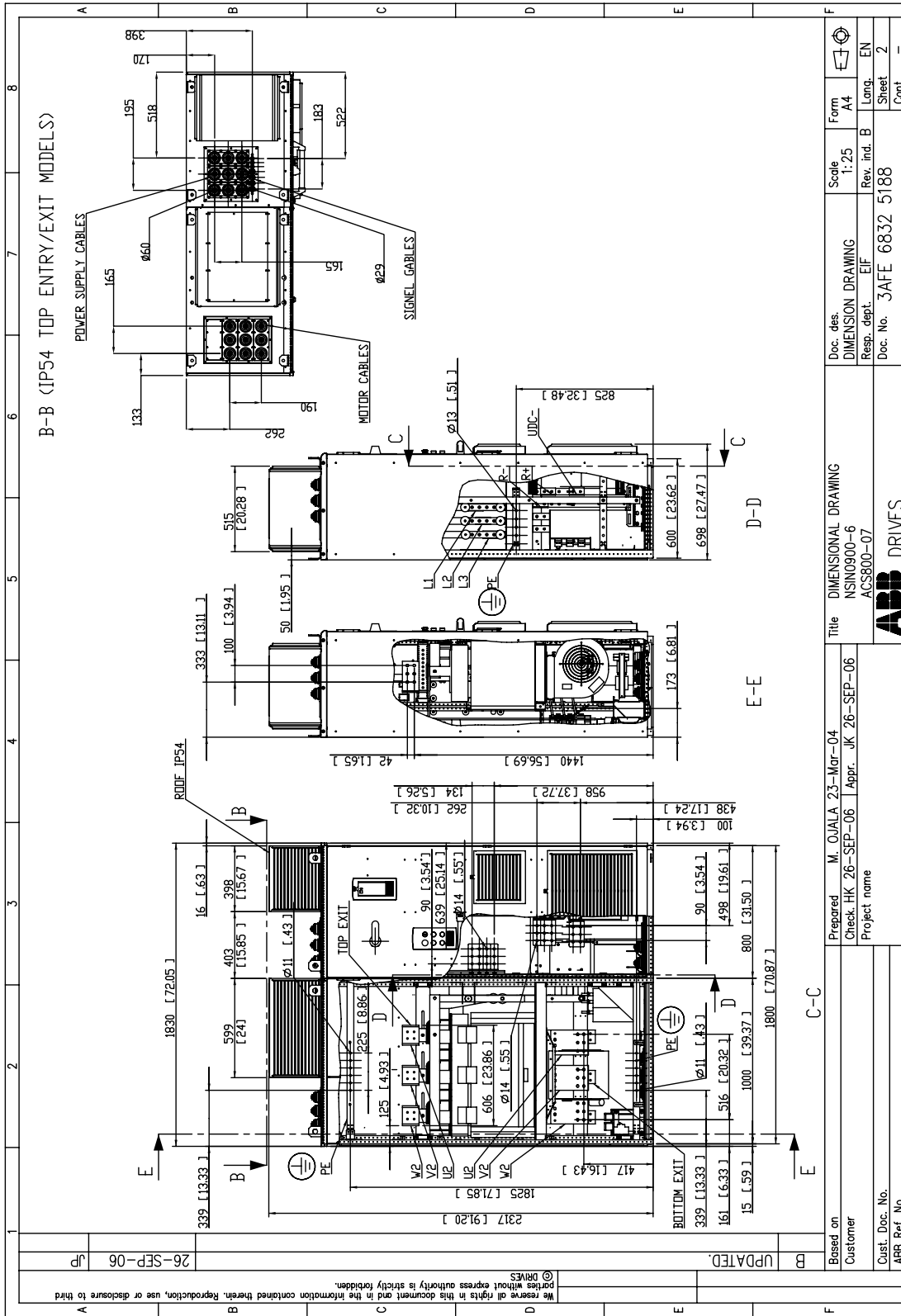

Note: NSIN0900-6 filter depicted. Dimensions also applicable to NSIN1380-6.

ACS800-07 with NSIN0900-6 and EMC filter +E202

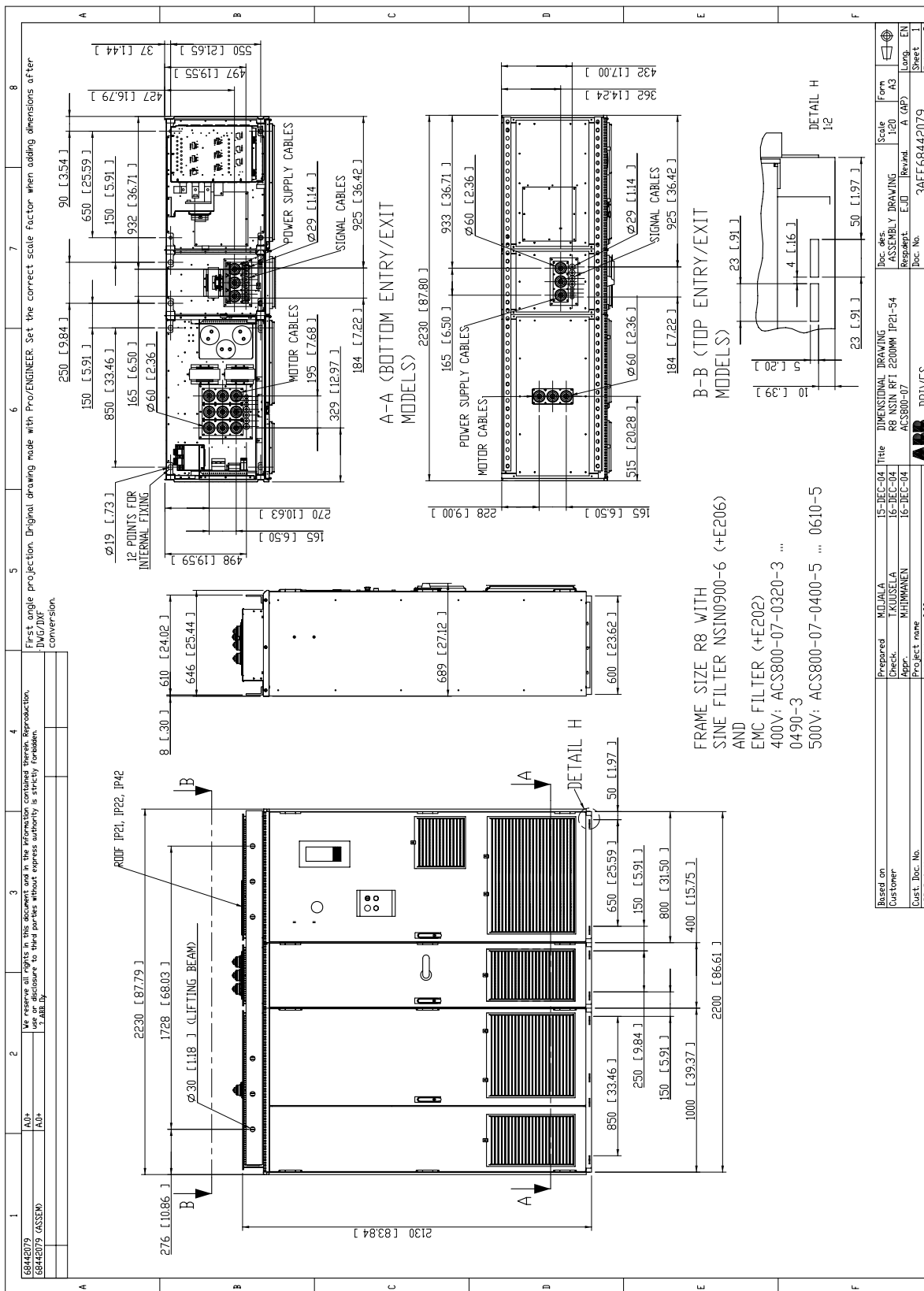

(continued)

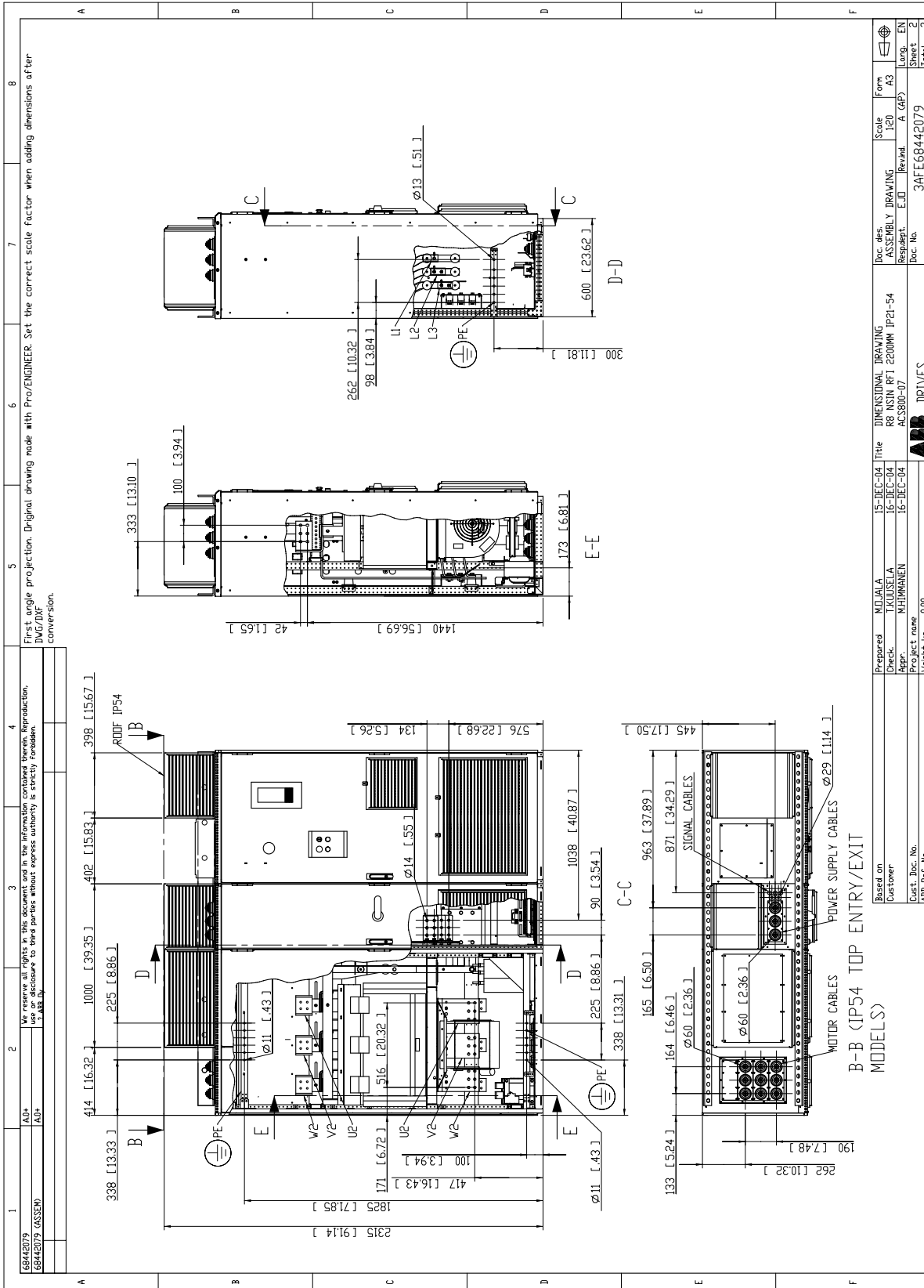

First angle projection. Original drawing made with Pro/ENGINEER. Set the correct scale factor when adding dimensions after DWG/DXF conversion.

Use reserved IP rights in this document for the information contained herein for reproduction, use or disclosure to third parties without express authority is strictly forbidden.
ABB Ltd.

Doc. No.	3AFE68442079	Form	A3
Scale	1:20	Reviz.	A (AP)
ASSEMBLY DRAWING		EJD	
Doc. des. Respect.	R8 NSIN RPT 2200MM TP2-54		
Project name	ABB DRIVES		
Weight kg	0.00		
Doc. Ref. No.			
Cust. Doc. No.			
Appr.	KHIMMANEN		
Check.	KJUUSELA		
Prepared	MJALIA		
Title	15-DEC-04		
16-DEC-04			
16-DEC-04			
Project name	ABB DRIVES		
Doc. No.	3AFE68442079		
Sheet	2		
Long. EN			
Total	2		



3AFE68389178 REV G / EN
EFFECTIVE: 15.05.2008

ABB Oy

AC Drives
P.O. Box 184
FI-00381 HELSINKI
FINLAND

Telephone +358 10 22 11
Fax +358 10 22 22681
Internet www.abb.com

ABB Inc.

Automation Technologies
Drives & Motors
16250 West Glendale Drive
New Berlin, WI 53151
USA

Telephone 262 785-3200
800-HELP-365
Fax 262 780-5135

ABB Beijing Drive Systems Co. Ltd.

No. 1, Block D, A-10 Jiuxianqiao Beilu
Chaoyang District
Beijing, P.R. China, 100015

Telephone +86 10 5821 7788
Fax +86 10 5821 7618
Internet www.abb.com