

**SSD Parvex SAS**

8, avenue du Lac - B.P. 249

F-21007 Dijon Cedex

www.SSDdrives.com



## DIGIVEX MOTION

CANopen

PVD 3518 GB – 01/2004

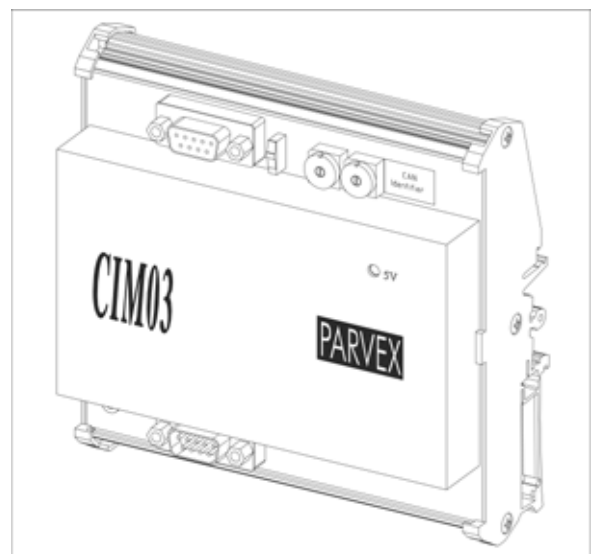
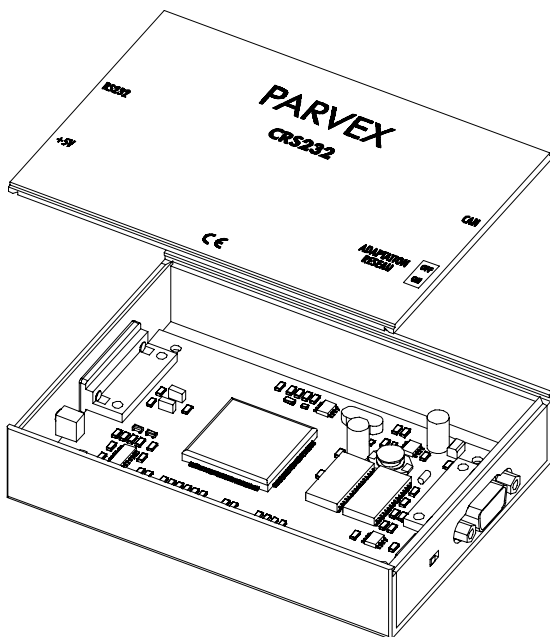
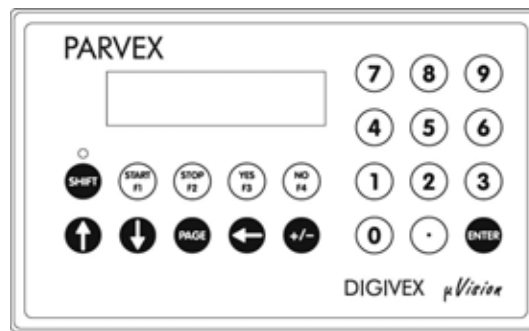

# PRODUCT RANGE

## 1 - « BRUSHLESS » SERVODRIVES

### TORQUE OR POWER RANGES

- **BRUSHLESS SERVOMOTORS, LOW INERTIA, WITH RESOLVER**  
 Very high torque/inertia ratio (high dynamic performance machinery):
  - ⇒ NX -HX - HXA
  - ⇒ NX - LX
- High rotor inertia for better inertia load matching:
  - ⇒ HS - LS
- Varied geometrical choice :
  - ⇒ short motors range HS - LS
  - ⇒ or small diameter motors : HD, LD
- Voltages to suit different mains supplies :
  - ⇒ 230V three-phase for «série L - NX»
  - ⇒ 400V, 460V three-phase for «série H - NX»
- **"DIGIVEX DRIVE" DIGITAL SERVOAMPLIFIERS**
  - ⇒ SINGLE-AXIS DSD
  - ⇒ COMPACT SINGLE-AXIS D $\mu$ D, DLD
  - ⇒ POWER SINGLE-AXIS DPD
  - ⇒ MULTIPLE-AXIS DMD
- "PARVEX MOTION EXPLORER" ADJUSTING SOFTWARE

1 to 320 N.m

0,45 to 64 N.m

3,3 to 31 N.m

3,3 to 31 N.m

9 to 100 N.m

## 2 - SPINDLE DRIVES

- **SPINDLE SYNCHRONOUS MOTORS**
  - ⇒ "HV" COMPACT SERIES
  - ⇒ "HW" ELECTROSPINDLE, frameless, water-cooled motor
- **"DIGIVEX" DIGITAL SERVOAMPLIFIERS**

From 5 to 110 kW  
up to 60,000 rpm

## 3 - DC SERVODRIVES

- **"AXEM", "RS" SERIES SERVOMOTORS**
- **"RTS" SERVOAMPLIFIERS**
- **"RTE" SERVOAMPLIFIERS** for DC motors + resolver giving position measurement

0.08 to 13 N.m

## 4 - SPECIAL ADAPTATION SERVODRIVES

- **"EX" SERVOMOTORS** for explosive atmosphere
- **"AXL" COMPACT SERIES SERVOREDUCTERS**

5 to 700 N.m

## 5 - POSITIONING SYSTEMS

- **Numerical Controls « CYBER 4000 »** 1 to 4 axes
- **"CYBER 2000" NC** 1 to 2 axes
- **VARIABLE SPEED DRIVE - POSITIONER**
  - ⇒ SINGLE-AXIS DSM
  - ⇒ POWER SINGLE-AXIS DPM
  - ⇒ MULTIPLE-AXIS DMM
- **ADJUSTMENT AND PROGRAMMING SOFTWARE PARVEX MOTION EXPLORER**

## Contents

<b>1. CAN</b>	<b>1-1</b>
<b>1.1 Introduction</b>	<b>1-1</b>
<b>1.2 Electrical Connections</b>	<b>1-1</b>
1.2.1 Connector description	1-1
1.2.2 CAN bus power supply	1-2
1.2.3 Connecting devices operating on CAN	1-2
1.2.4 CAN Cable characteristics	1-3
<b>1.3 Connecting for drives setting</b>	<b>1-3</b>
1.3.1 General points	1-3
1.3.2 Application example with CRS232B interface	1-4
1.3.3 Application example with CIM03B interface	1-5
1.3.4 Application example with RS232CAN interface	1-6
<b>1.4 CANopen characteristics</b>	<b>1-7</b>
<b>1.5 Cables connecting Diagrams</b>	<b>1-7</b>
<b>2. CRS232 / CIM03</b>	<b>2-1</b>
<b>2.1 Introduction</b>	<b>2-1</b>
<b>2.2 Physical Presentation</b>	<b>2-1</b>
2.2.1 CRS232 / CRS232B	2-1
2.2.2 CIM03 / CIM03B	2-2
<b>2.3 Dimensions</b>	<b>2-3</b>
<b>2.4 RS232 connector</b>	<b>2-5</b>
<b>2.5 CRS232 and CIM03 Technical Characteristics</b>	<b>2-5</b>
<b>3. µVISION TERMINAL</b>	<b>3-1</b>
<b>3.1 Introduction</b>	<b>3-1</b>
<b>3.2 Description</b>	<b>3-1</b>
<b>3.3 Dimensions</b>	<b>3-3</b>
<b>3.4 Technical Characteristics</b>	<b>3-3</b>
<b>3.5 Use</b>	<b>3-5</b>
3.5.1 Description of the various pages displayed	3-5
3.5.2 Enter a value - Answer a question	3-6
3.5.3 How to use the F1, F2, F3 and F4 keys	3-6
<b>3.6 µVision terminal configuration</b>	<b>3-6</b>
3.6.1 Changing the subscriber number	3-6
3.6.2 Changing user name	3-6
3.6.3 Changing CAN network baud rate	3-7

3.6.4	Configuration of functions F1, F2, F3 and F4	3-7
3.6.5	CANopen norm	3-8

Characteristics and dimensions subject to change without notice.

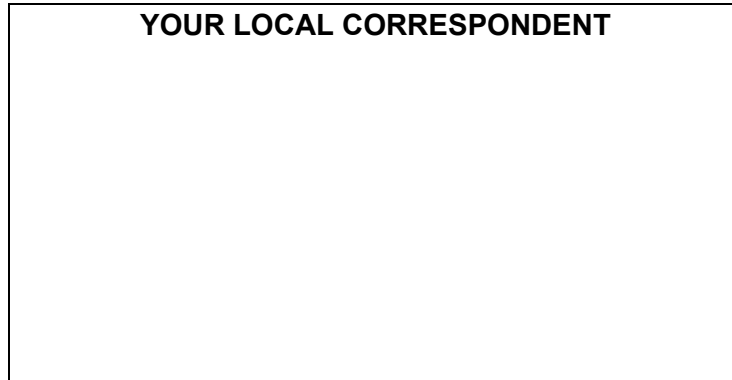

**SSD Parvex SAS**  
8 Avenue du Lac / B.P 249 / F-21007 Dijon Cedex  
Tél. : +33 (0)3 80 42 41 40 / Fax : +33 (0)3 80 42 41 23  
[www.SSDdrives.com](http://www.SSDdrives.com)

### Available DIGIVEX MOTION instructions

◆ DIGIVEX Single Motion (DSM) User Manual	(DSM)	PVD3515
◆ DIGIVEX Power Motion (DPM) User Manual	(DPM)	PVD3522
◆ DIGIVEX Multi Motion (DMM) User Manual	(DMM)	PVD3523
◆ DIGIVEX Motion - CANopen		PVD3518
◆ DIGIVEX Motion - Profibus		PVD3554
◆ PME-DIGIVEX Motion Adjustment Manual		PVD3516
◆ DIGIVEX Motion Directory of Variables		PVD3527
◆ DIGIVEX Motion Programming		PVD3517
◆ DIGIVEX Motion - Cam Function		PVD3538
◆ PME Tool kit User and Commissioning Manual		PVD3528
◆ CANopen - CAN Bus Access via CIM03		PVD3533
◆ CANopen - Remote control using PDO messages		PVD3543
◆ "Block Positioning" Application Software		PVD3519
◆ "Fly shear linear cutting" software application		PVD3531
◆ "Rotary blade cutting" software application		PVD3532

# 1. CAN

## 1.1 Introduction

Data is exchanged between DIGIVEX MOTION CANopen positioners, CRS232 or CIM03 interface boards and  $\mu$ Vision terminals via a CAN (Control Area Network) field bus. Reliability and high speed are the main advantages of this automotive industry serial bus. Information is encoded by the CANopen protocol.

## 1.2 Electrical Connections

### 1.2.1 Connector description

The CAN bus is connected by 9-pin SUB-D connectors (9-pin SUB-D plugs on devices):

PIN	TYPE	FUNCTION	CHARACTERISTICS	
2	CAN-L	CAN bus data transmission	CAN bus differential signal	Differential pair
7	CAN-H		CAN bus differential signal	
3	0VC	Power supply	0V (CAN driver 0V and power supply)	Input or output
9	24VC			
1		NC	not used	
4			not used	
5			not used	
6			not used	
8			not used	

### 1.2.2 CAN bus power supply

The CAN interfaces of each device require a +24 V power supply to operate.

As a rule, this power must be supplied independently of the various devices connected to the network.

However, DIGIVEX MOTION devices can provide a 24 V power supply with short-circuit and inversion protection. This power supply can provide 100 mA (2.4 W at 24 V).

When several DIGIVEX MOTION devices are connected to the CAN bus, their +24 V power supplies are added (e.g. if two DIGIVEX MOTION devices are connected to the bus, the power available will be  $2.4\text{ W} \times 2 = 4.8\text{ W}$ ).

### 1.2.3 Connecting devices operating on CAN

The various devices on the CAN network are hooked up 2 by 2 by a DIG05982R1-- cable (see drawing FELX 305981) with two connectors (plug and socket) at each end.

A  $120\ \Omega$  resistor is to be inserted at each end of the line. This may be done either through a CAN DIG05984R100 terminal (see drawing FELX 305983), or, where a CRS232 module is the line end, by setting the module adapter switch to ON.

#### Comments :

depending on the overall length of the network (between the two end resistors), a certain transmission speed must not be exceeded. (See the separate device instructions for how to adjust the baud rate).

Baud rate (kbaud)	Maximum length (m) main line
1000	25
500	100
250	250
125	500
50	1000
20	2500
10	5000

- As a general rule, drifts from the main string are not authorised. Although, drifts that are less than 1m can be tolerated.

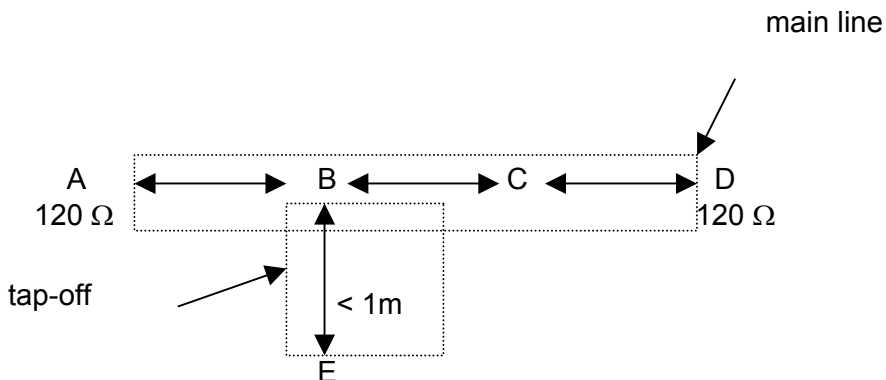

### 1.2.4 CAN Cable characteristics

The CAN cable is a particular type of cable:

- General shielding is connected to the metal-plated Sub-D connector cover.
- 1 twisted pair for +24V power supply (0.5mm<sup>2</sup> conductors, 20°C ≤ 40.7 Ω/km linear resistance).
- 1 twisted pair for the signal (0.15mm<sup>2</sup> conductors, 20°C ≤ 143 Ω/km linear resistance, 120 Ω ± 10% at 1 MHz impedance, 62pF/m at 1 MHz capacity between conductors).



The above wiring characteristics must be respected in full to avoid communication problems.

## 1.3 Connecting for drives setting

### 1.3.1 General points

To set a DIGIVEX Motion drive from a PC using PME software, it is necessary to use one of the following interfaces :

REFERENCE	DESIGNATION
CRS232B CIM03B	RS232-CANopen Interfaces
RS232CAN	RS232 interface can communicate with one drive at a time Caution! It is only possible to use this interface if the drive is not connected to CAN network (the drive mustn't use CAN bus to communicate with another drive or another device)

### 1.3.2 Application example with CRS232B interface

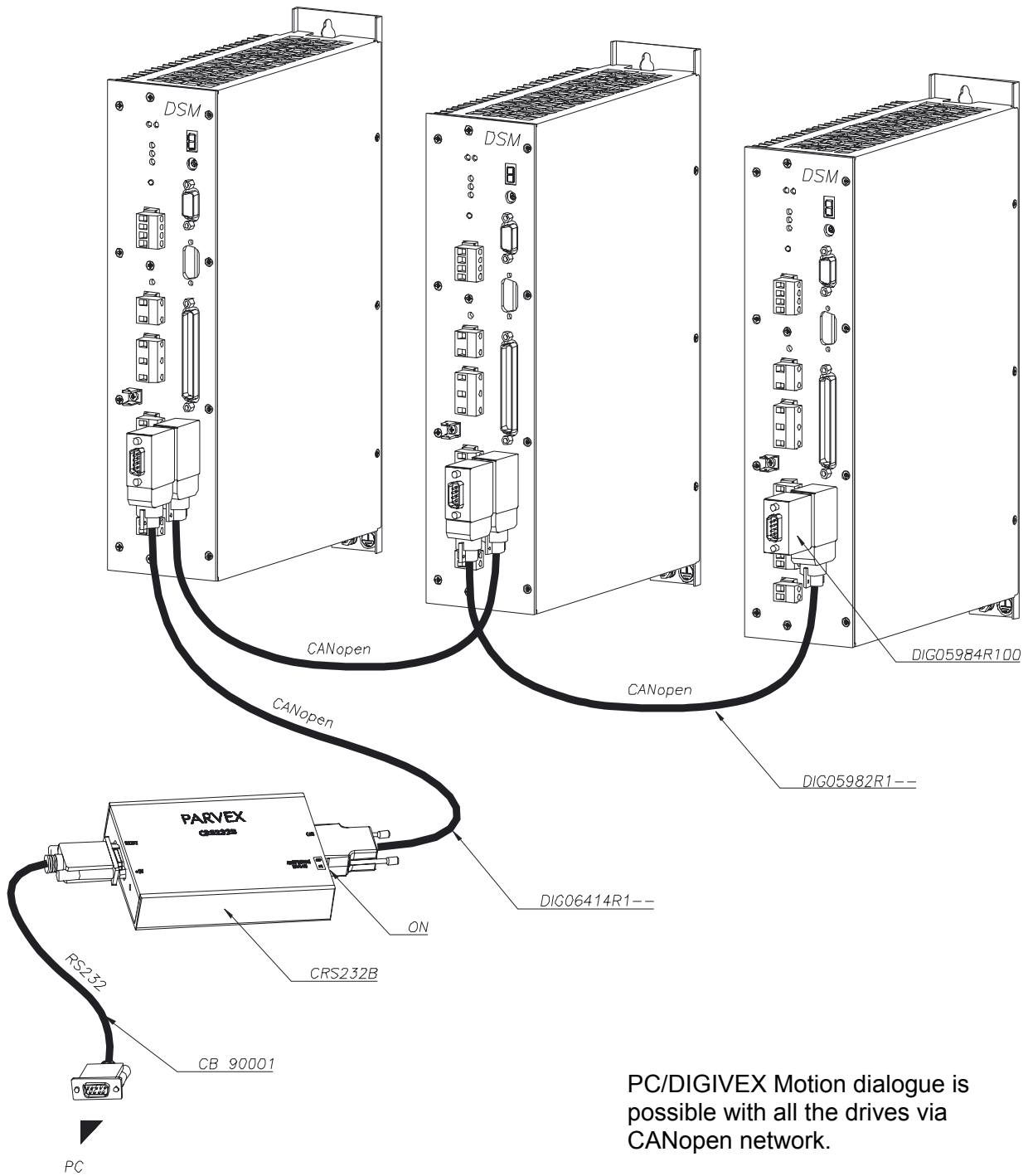

PC/DIGIVEX Motion dialogue is possible with all the drives via CANopen network.



### 1.3.3 Application example with CIM03B interface

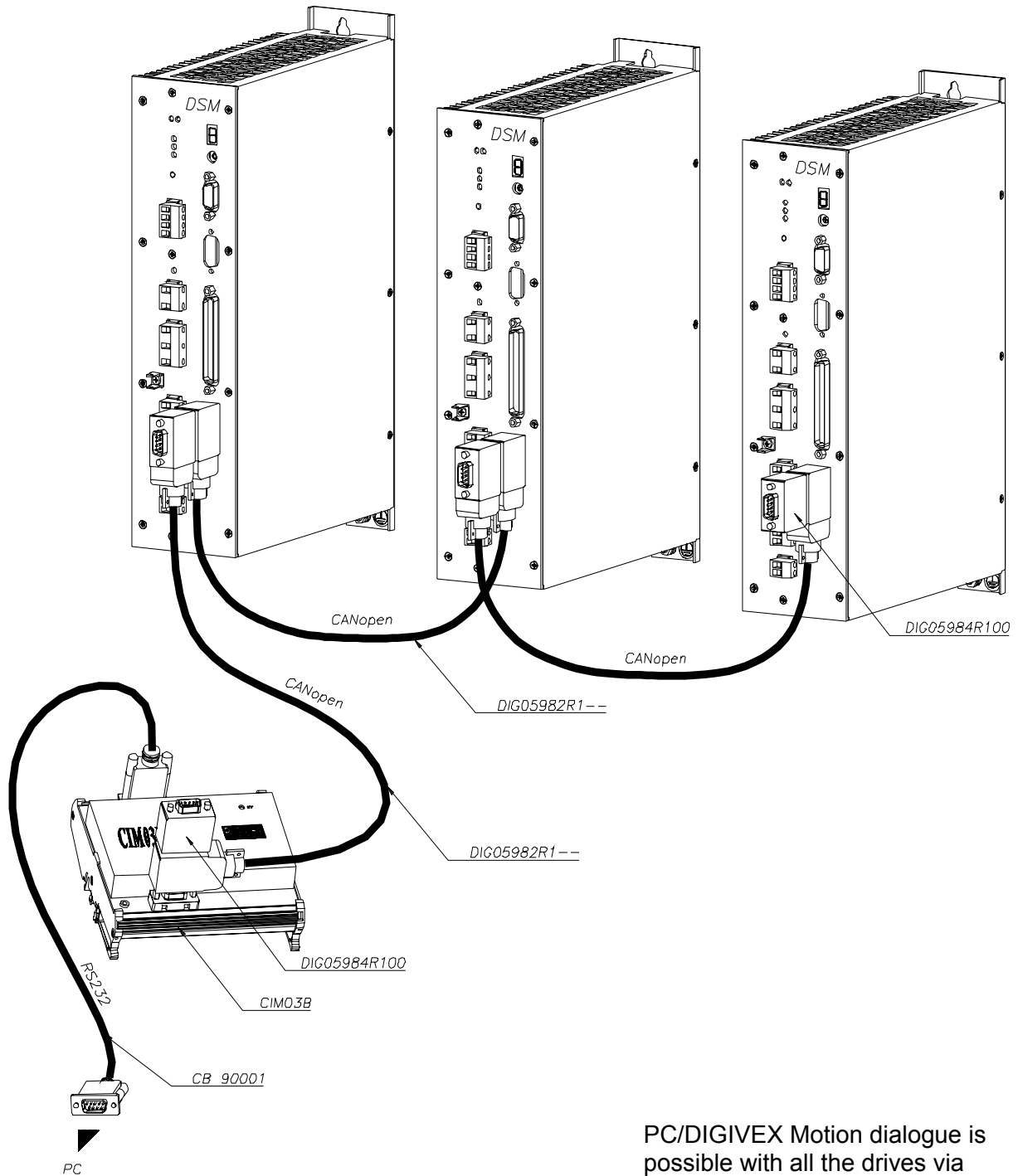

PC/DIGIVEX Motion dialogue is possible with all the drives via CANopen network.

**1.3.4 Application example with RS232CAN interface**  
 (the drive mustn't be connected to PROFIBUS network)

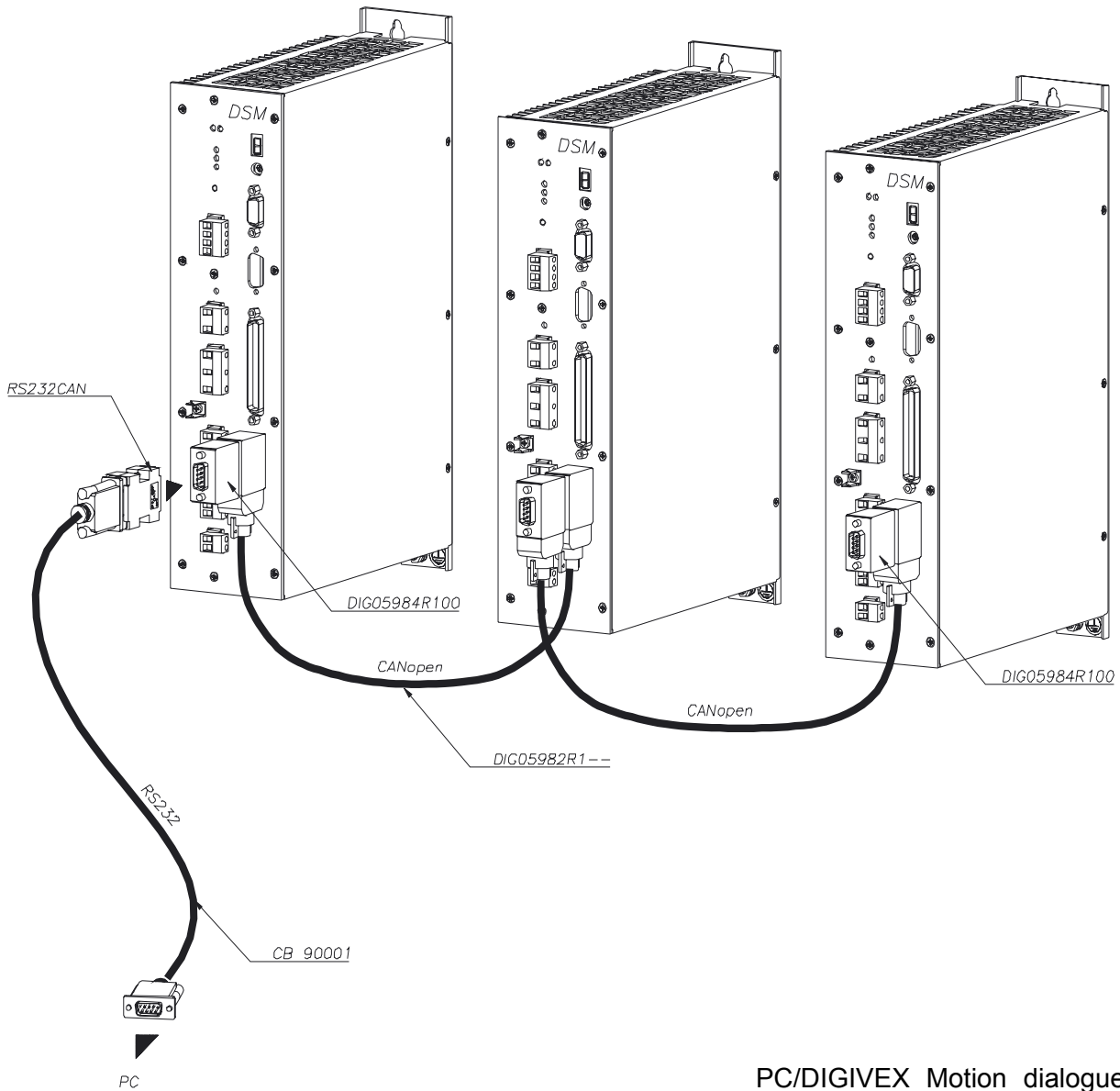

PC/DIGIVEX Motion dialogue is only possible with one drive at a time.

The drive mustn't use CAN bus to communicate with another drive or another device when RS232PRO is used.

## 1.4 CANopen characteristics

NMT	Slave
Error Control	Node Guarding
Node ID	HW Switch
No. of PDOs	4 Rx            4 Tx
PDO Modes	Sync (cyclic)
PDO Linking	No
PDO Mapping	Variable
No. of SDOs	4 Server        1 Client
Emergency Message	Yes
CANopen Version	DS-301 V4.0
Framework	No
Device Profile	DSP-402 V1.1
Certified	No

- **NMT [Master/Slave]:** Describes the role of an appliance within the network. A NMT Master appliance is capable of initializing the network, whilst a NMT Slave appliance is not. NMT = Network Management (a procedure for managing the network).
- **Error Control [Node Guarding / Heartbeat / No]:** Describes the control mechanism for errors tolerated by the appliance. Node Guarding is a mechanism that, given an appliance which fulfils the role of a NMT Master, monitors the NMT Slave appliances. Heartbeat is a mechanism that cyclically transmits messages via the appliance in question, indicating its presence to other members of the network.
- **Node ID [LMT / HW Switch / Proprietary]:** Describes the way in which the CAN identifier is assigned to the appliance in question. HW Switch indicates that the identifier is assigned mechanically. LMT indicates that the identifier can be assigned using a message procedure known as LMT (Layer Management). Proprietary indicates a method of assignation different from the first two.
- **No. of PDOs [n RX / m Tx]:** Indicates how many receiving and transmitting PDOs can be managed by the appliance.
- **PDO Modes:** Indicates which PDO transmission modes can be managed by the appliance.
- **PDO Mapping [Default / Variable]:** Indicates whether the appliance accepts a change in the data to be transmitted to the inside of PDO messages.
- **No. of SDOs [n Server / m Client]:** Indicates how many Client and Server SDO channels can be managed by the appliance.
- **Emergency Message [Yes / No]:** Indicates whether the appliance is capable of managing EMCY messages (emergency messages).
- **CANopen Version:** Indicates which version of the CANopen procedure is implemented in the appliance.
- **Device Profile:** Indicates which CANopen standard is respected by the appliance (DSP 402 = Speed Controllers and Positioners).
- **Certified:** Indicates whether the appliance is certified (CiA Certification).

## 1.5 Cables connecting Diagrams

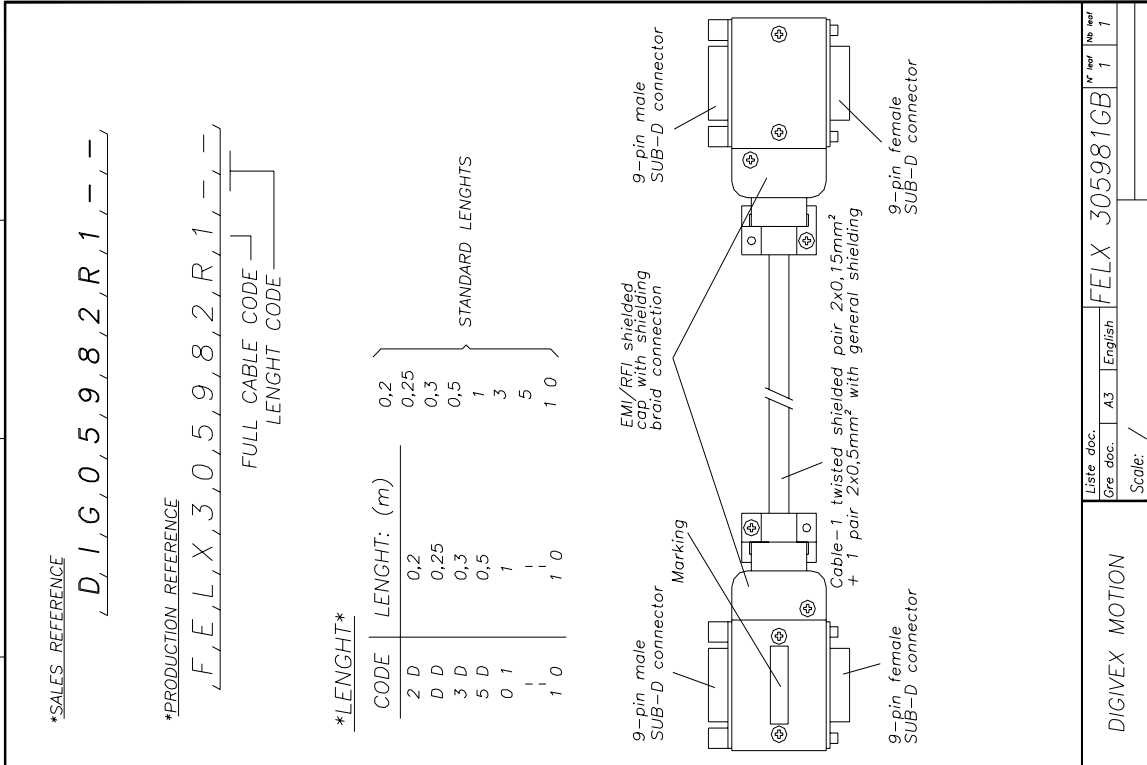
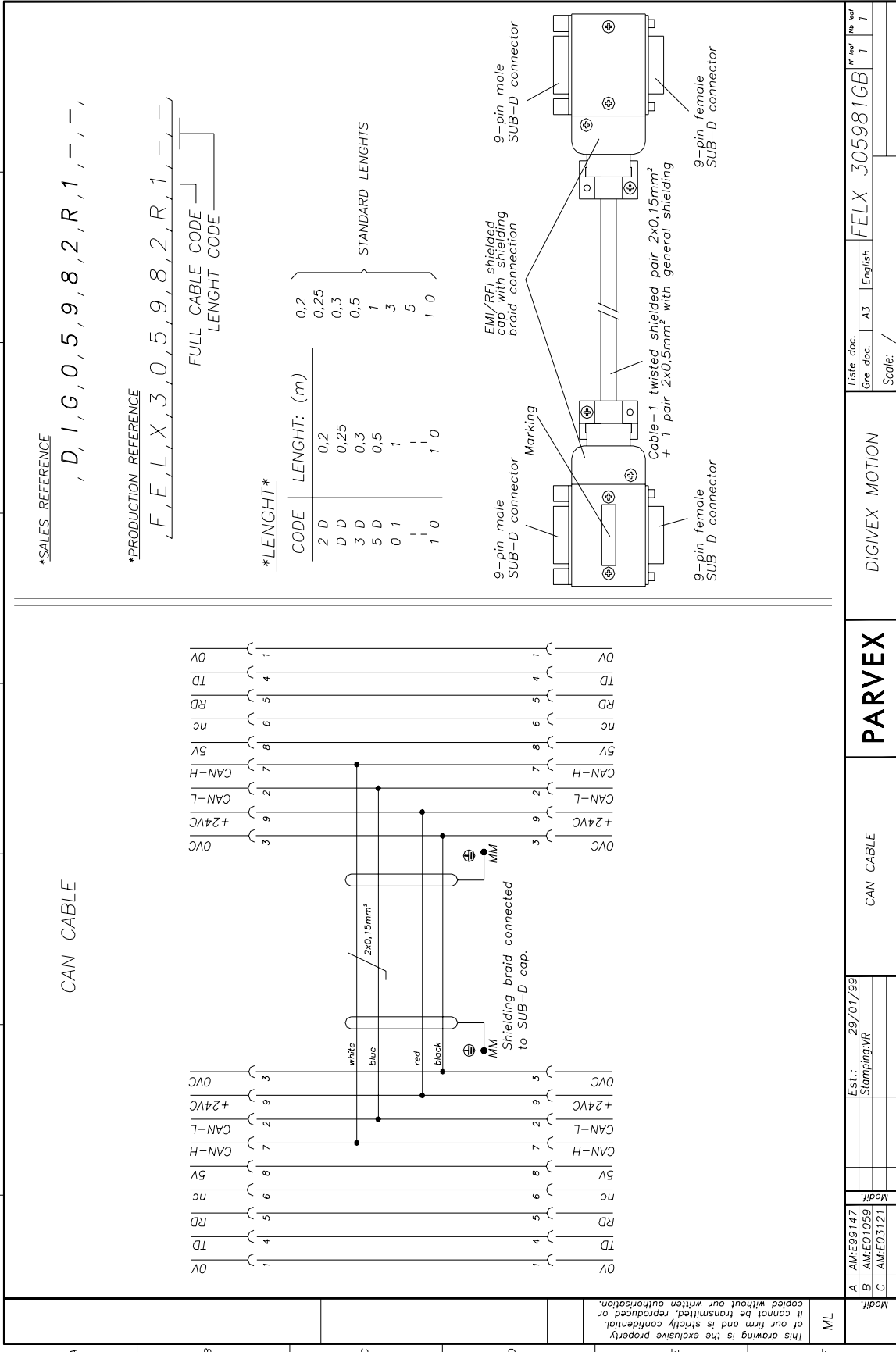

A		7	8
B	CAN CABLE	DIGIVEX MOTION	FELX 305981GB
C	PARVEX	A3 English	1 1
D	CAN CABLE	Gre doc. /	1 1
E	Est.: 29/01/99 Stamping:VR	Scale: /	1 1
F	Modif.: A AM:E99147 B AM:E01059 C AM:E03121		
F	This drawing is the exclusive property of our firm and is strictly confidential. It cannot be transmitted, reproduced or copied without our written authorisation.		

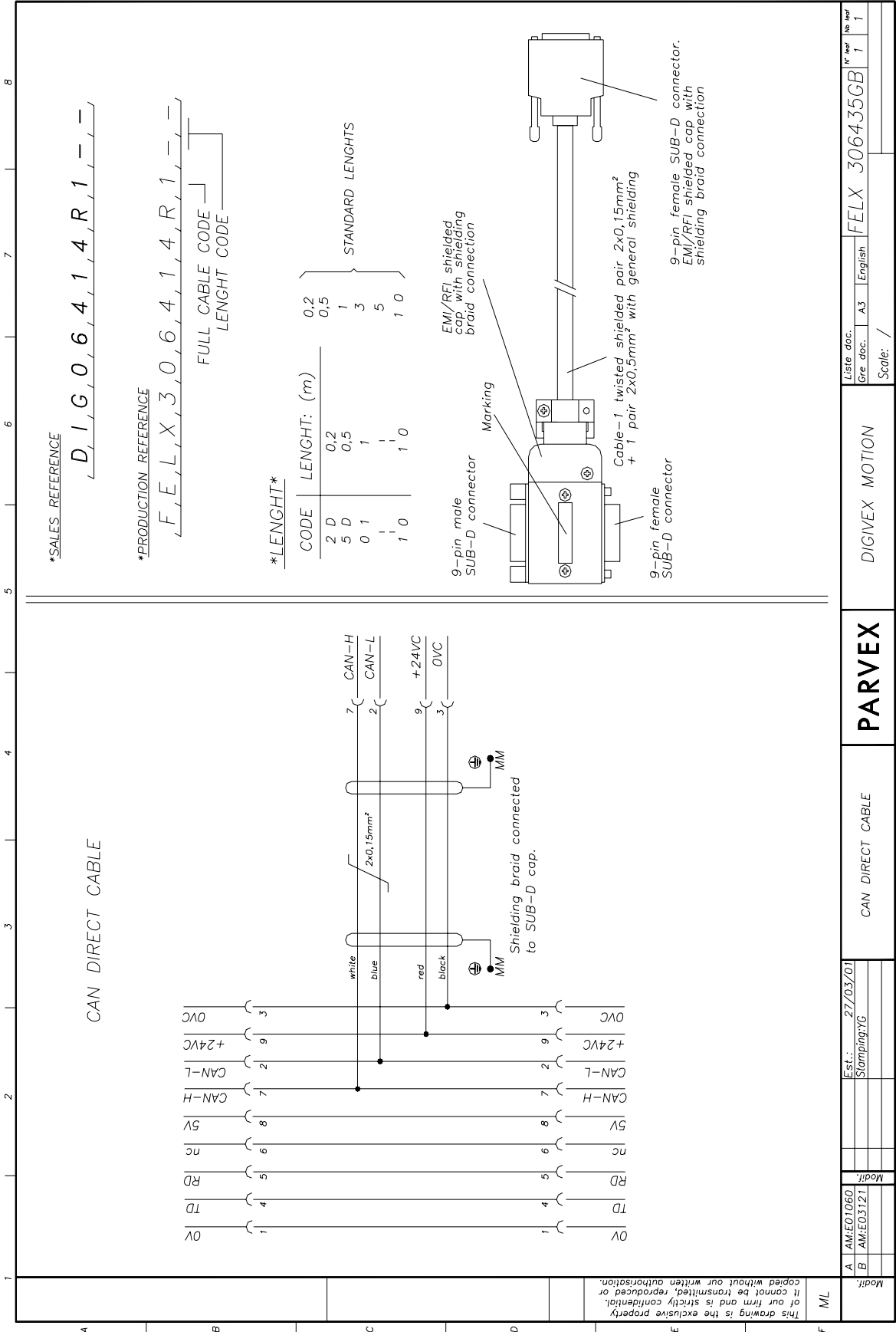

Modif:	A AME01060	Est.: 27/03/01	Stamping:YG	Liste doc. FELX 306435GB	N° rev 1	M# rev 1
	B AME03121					
<b>PARVEX</b>			<b>DIGIVEX MOTION</b>			

ML  
This drawing is the exclusive property of our firm and is strictly confidential. It cannot be transmitted, reproduced or copied without our written authorization.

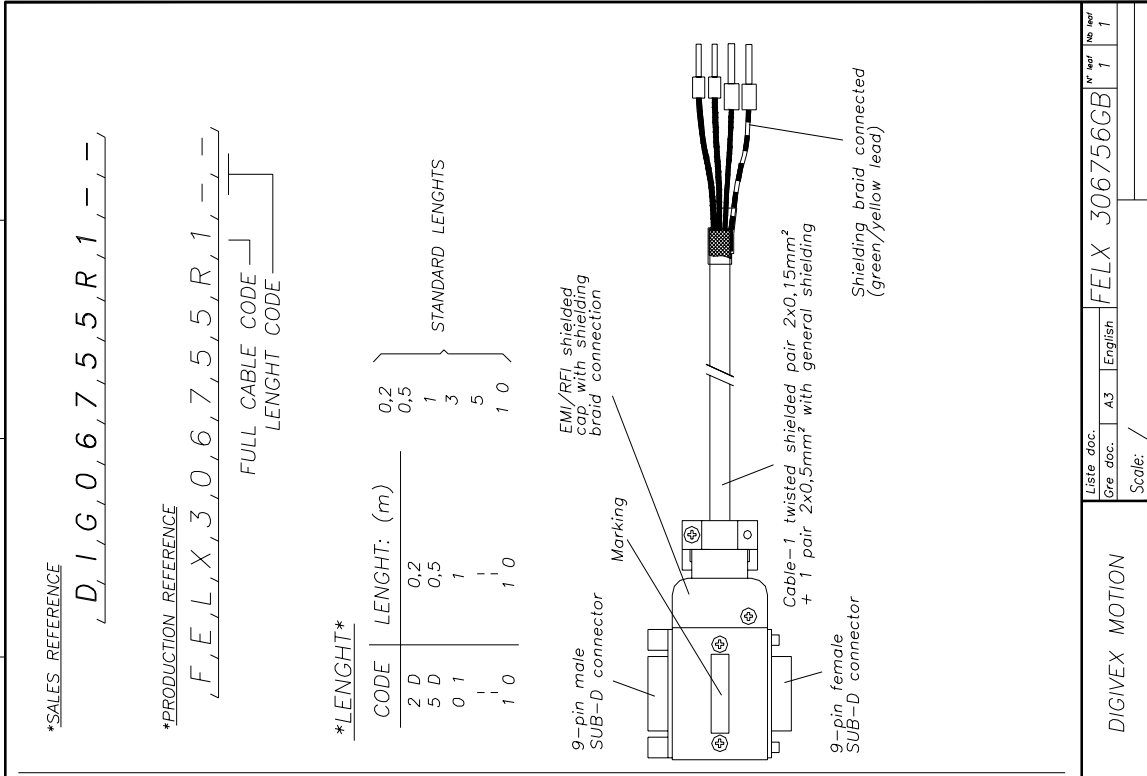
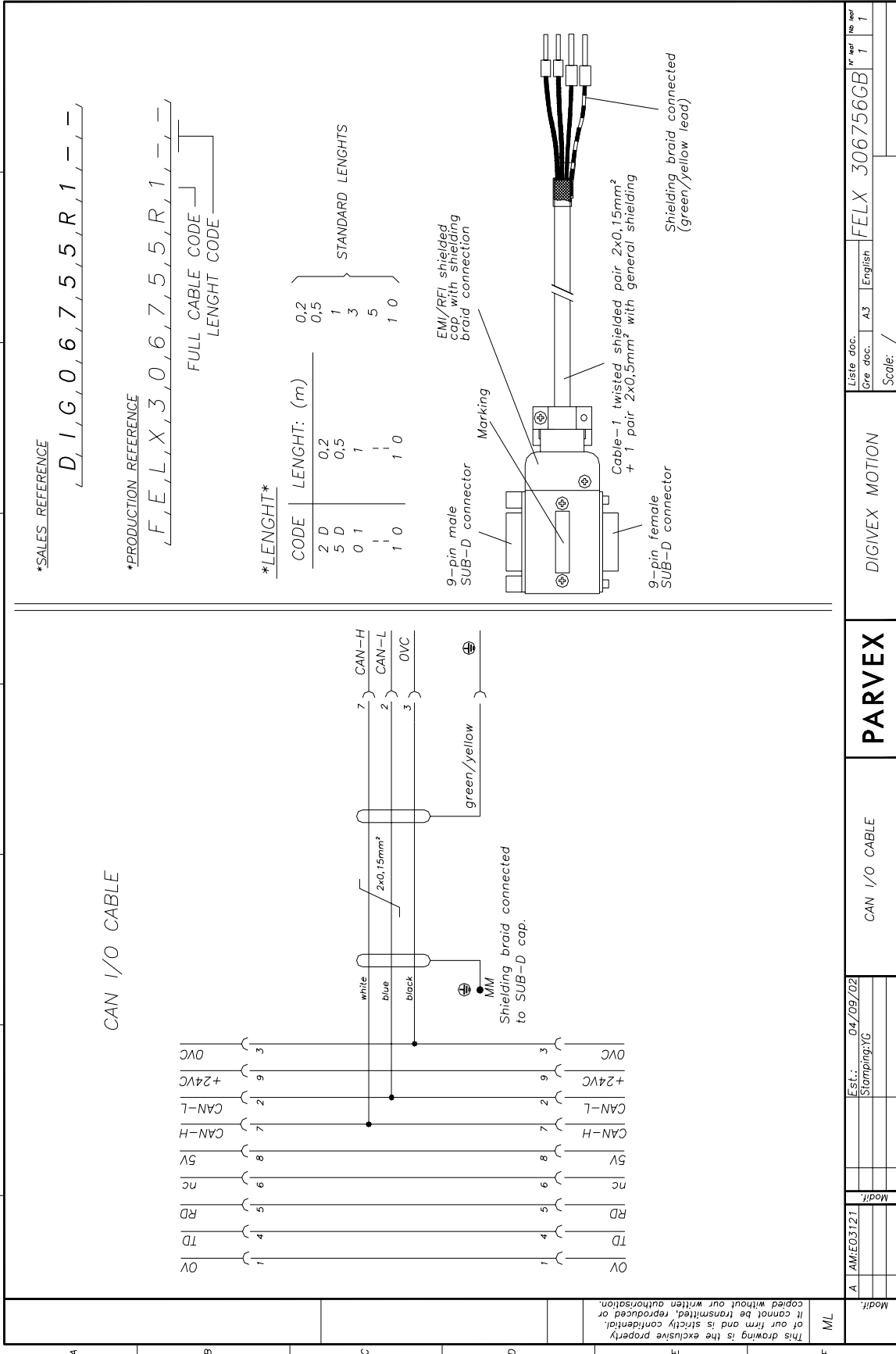

A	AM: E03121	Est.: 04/09/02	FELX 306756GB	1	1
		Stamping: YG			
Modif:			Scale: /		
CAN I/O CABLE			DIGIVEX MOTION		
<b>PARVEX</b>					
<p>This drawing is the exclusive property of our firm and is strictly confidential. It cannot be transcribed, reproduced or copied without our written authorisation.</p>					
ML					

12345678

ABCDEF

**CAN CABLE FOR ABSOLUTE ENCODER 24V**

**\*SALES REFERENCE**

DIG06868R1---

**\*PRODUCTION REFERENCE**

FELX306868R1---

FULL CABLE CODE  
LENGHT CODE

**\*LENGHT\***

CODE	LENGHT: (m)	STANDARD LENGHTS
2 D	0.2	}
5 D	0.5	
0 1	1	
1 1	3	
1 0	5	
	1.0	

AAM: E03121Est.: 27/01/03Stamping: YGCAN CABLEPARVEXDIGIVEX MOTIONFELX 306869GB1<sup>st</sup> rev1

Modif.

This drawing is the exclusive property of our firm and is strictly confidential. It cannot be transmitted, reproduced or copied without our written authorisation.

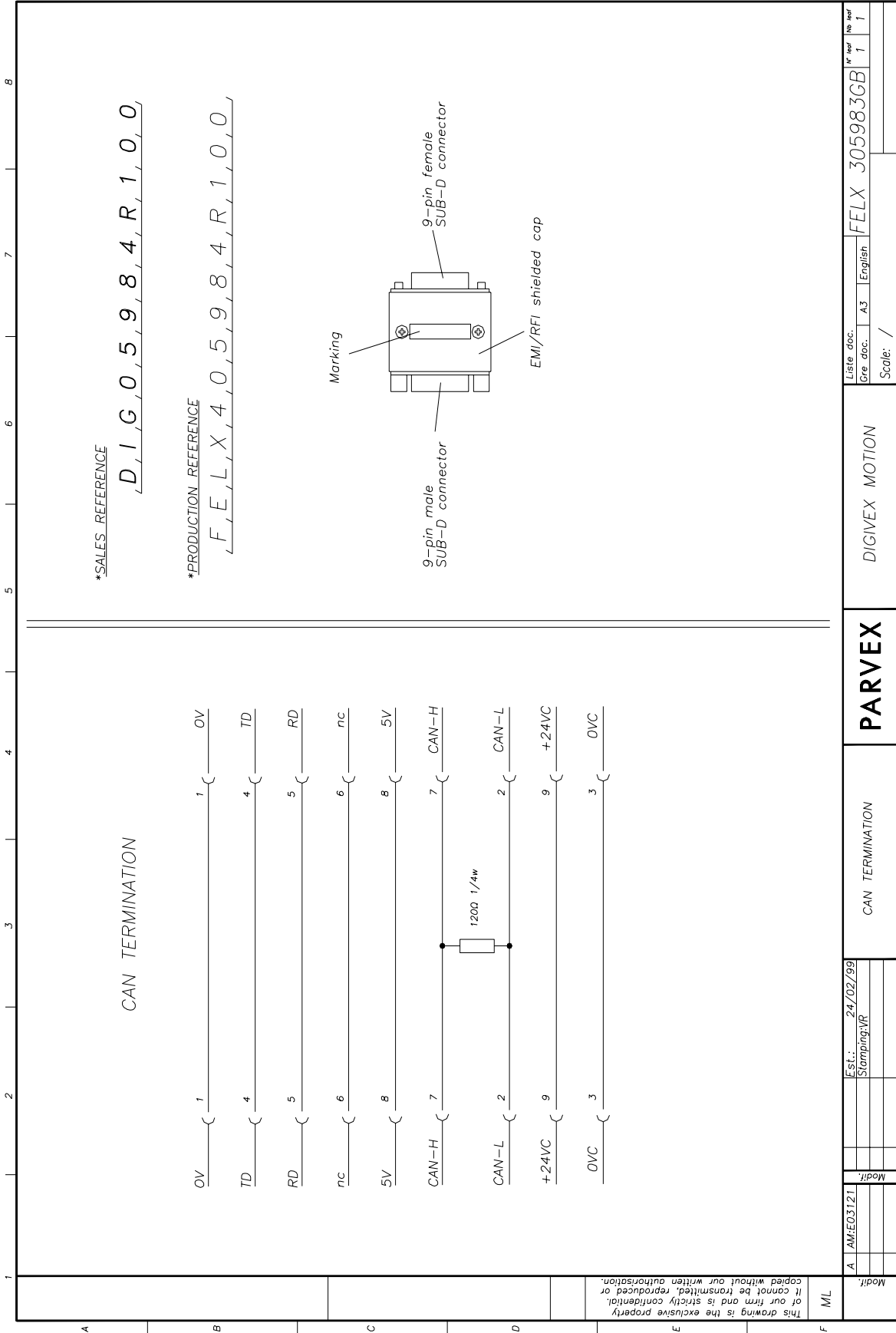

This drawing is the exclusive property of our firm and is strictly confidential. It cannot be transmitted, reproduced or copied without our written authorization.

A	AM:EQ3121	Est.: 24/02/99	PARVEX	DIGIVEX MOTION	FELX 305983GB	N° ref 1	No. ref 1
	Modif:	Stamping:VR					
F	ML						







## 2. CRS232 / CIM03

### 2.1 Introduction

CRS232 or CIM03 interface boards are used for connecting a PC to a CAN network via an RS232 serial link in order to set DIGIVEX MOTION CANopen positioner module parameters.

It is possible to carry out remote reinitialization for the CRS232B and CIM03B versions of these interfaces (use of Parvex Motion Explorer software is required).

### 2.2 Physical Presentation

#### 2.2.1 CRS232 / CRS232B

The CRS232/CRS232B converter is a box unit.

- One side provides access to the serial link via a 9-pin SUB-D socket,
- The other side provides access to the CAN network via a 9-pin SUB-D plug.

A switch (next to the CAN 9-pin SUB-D plug) allows the line to be adapted to 120  $\Omega$  depending on the other nodes in the network (see CAN section).

A green LED (next to the 9-pin SUB-D socket) indicates the status of the power supply to the board.

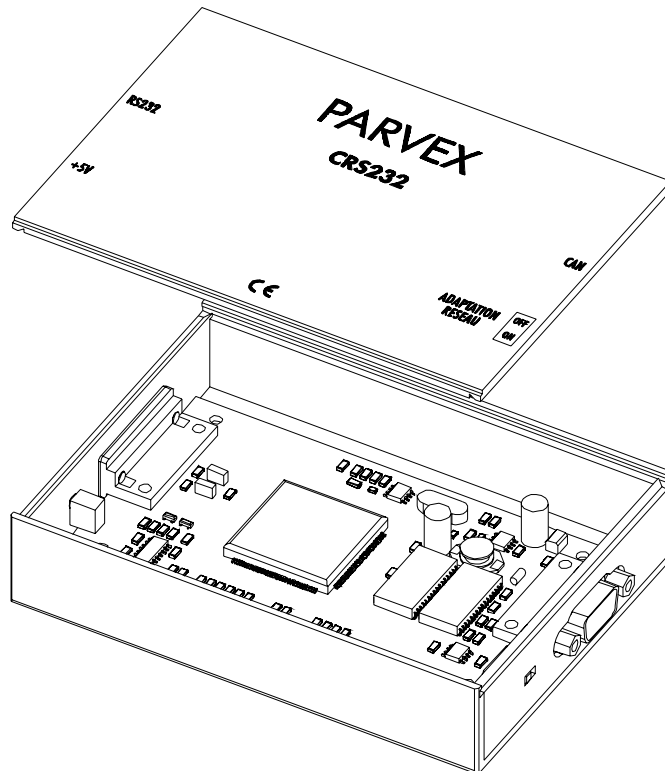

Figure 1: CRS232/CRS232B board in its housing

## 2.2.2 CIM03 / CIM03B

The CIM03 / CIM03B converter is a box module mounted on DIN rails for easier wiring of the electrical cabinet.

Access can be gained:

- at one end to the serial link via a 9-pin SUB-D female connector
- at the other end to the CAN network via a 9-pin SUB-D male connector

If the CIM03 converter is located at the end of the CAN network line, fit a 120  $\Omega$  impedance plug to its CAN connector (see CAN Section).

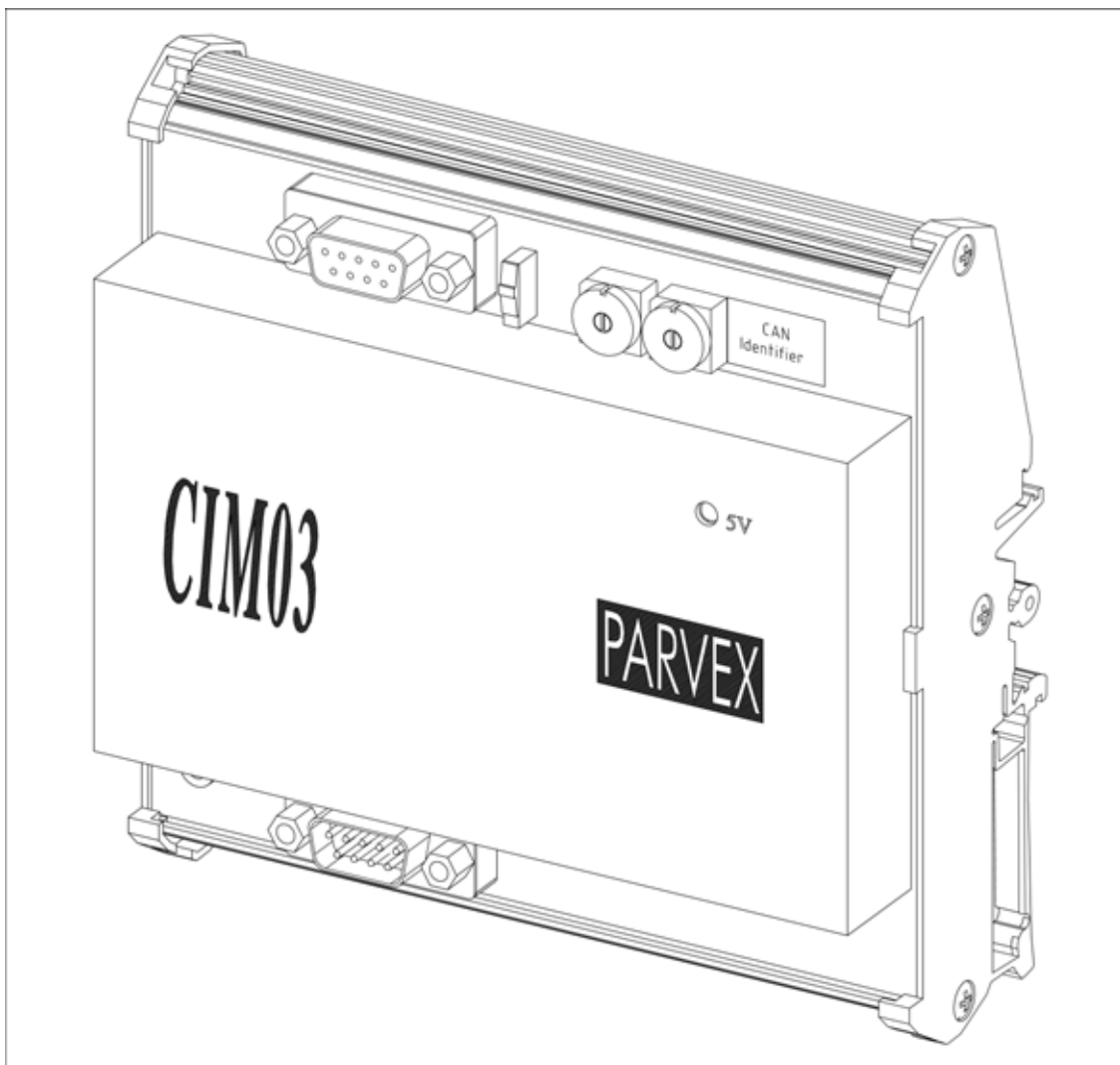

Figure 2: CIM03 / CIM03B converter

A switch (located next to the RS232 9-pin SUB-D female connector) is used for selecting "PC" mode (CIM03 connected to a PC via the RS232 serial link) or "STAND ALONE" mode (CIM03 connected to a terminal other than a PC, e.g. a PLC or electronic board with a serial link).

The two "CAN identify" rotating switches are not actually used (the set address is not taken into account).





## 2.4 RS232 connector

DIGIVEX INTERNAL LINKS	DIGIVEX 9-PIN SUB-D CONNECTOR	PC	PC 9-PIN SUB-D CONNECTOR
	1	DCD	1
	2	TD (TXD)	2
	3	RD (RXD)	3
	4	DTR	4
	5	0V	5
	6	DSR	6
	7	RTS	7
	8	CTS	8
	9	Ring Indicator	9

The connector body is earthed. Use a serial extension cable (non-crossed RD and TD) maximum length 5 m.

Only TD, RD and 0V signal wiring is compulsory with PME DIGIVEX MOTION software.

## 2.5 CRS232 and CIM03 Technical Characteristics

Power Supply		
Typical CAN supply voltage	24	VDC
Min. CAN supply voltage	20	VDC
Max. CAN supply voltage	28	VDC
Typical consumption	1,6	W





## 3. µVISION TERMINAL

### 3.1 Introduction

---

The DTP02 µVision terminal is designed for use with one or more DIGIVEX Motion CANopen positioners for entering application-related values or viewing error messages. The µVision terminal connects up to the positioner(s) via a CAN link.

**IMPORTANT:** Before using the µVision terminal you first have to enter parameters for:

- Its number and its CAN subscriber number (§3.6.1 and §3.6.2)
- Its CAN transmission speed (§3.6.3)
- Commands associated with **F1**, **F2**, **F3** and **F4** keys (§3.6.4)

This data must be entered before the µVision terminal is put into service. The data is then stored in EEPROM memory.

### 3.2 Description

---

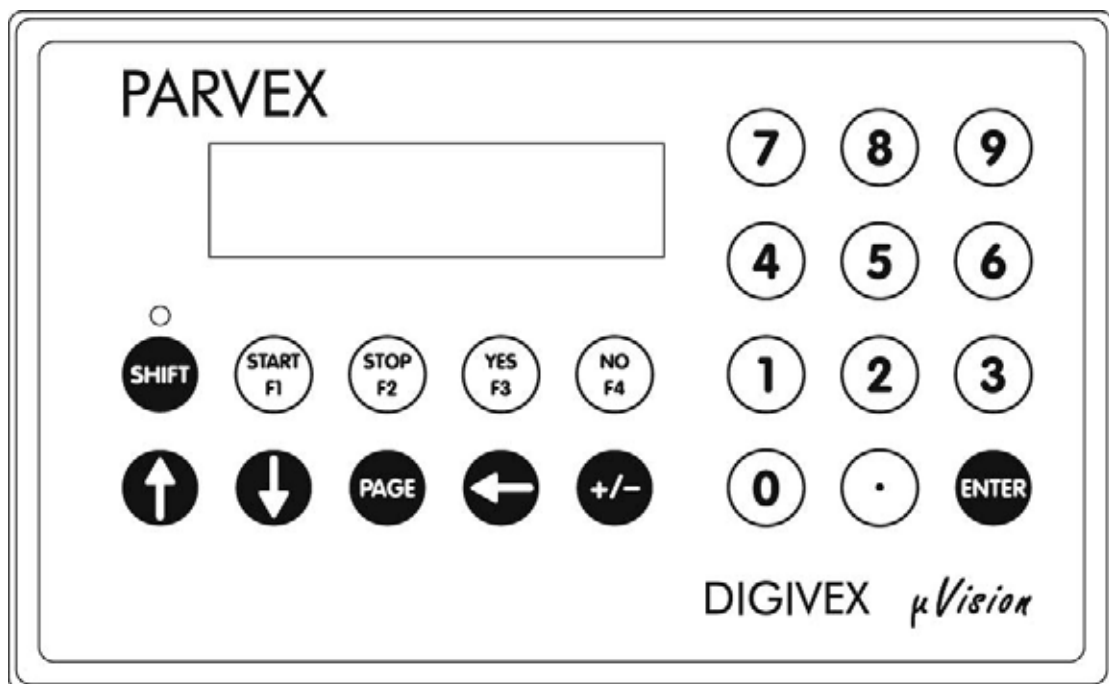

\* FASTENING:

The µVision terminal may be hand-held or screw mounted (e.g. to an electrical cabinet door) (cf. dimensional drawing).

\* SCREEN:

2 lines of 16 characters

\* 22 KEY KEYBOARD:

Because the µVision terminal is made from thermoformed plastic, the keys should not be pressed with sharp instruments such as screwdrivers.

Keys:

<b>SHIFT</b>	allows access to user-defined functions F1, F2, F3 & F4. A red LED shows whether the Shift key is activated. It is deactivated after any key is pressed and acknowledged.
<b>START</b>	validates (command for all connected positioners) Function currently unavailable.
<b>STOP</b>	interrupts (command for all connected positioners) Function currently unavailable.
<b>YES</b>	positive answer to a prompt (returns digit 1)
<b>NO</b>	negative answer to a prompt (returns digit 0)
<b>↑</b>	Select the previous page
<b>↓</b>	Select the following page
<b>PAGE</b>	selects a page from 0 to 9 for display
<b>←</b>	erases the character before the cursor
<b>+/-</b>	enables the user to key in negative values
<b>ENTER</b>	validates a numerical value or YES/NO answer keyed in
<b>0..9, .</b>	number pad for entering numerical values

### 3.3 Dimensions

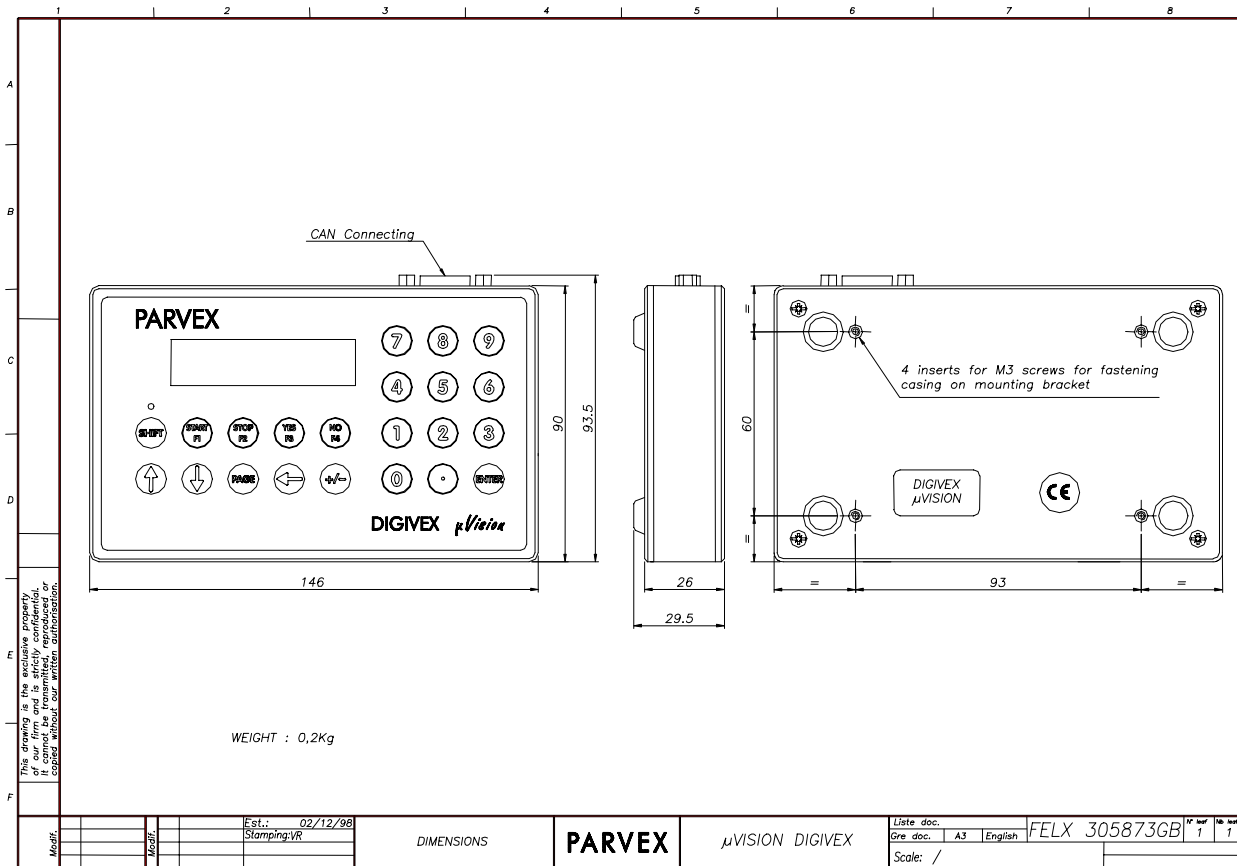

### 3.4 Technical Characteristics

CAN bus (ISO/DIS 11898)		
CAN bus connector	9-pin SUB-D plug	
Electrical connections	See CAN section	
CAN baud rate	10, 20, 50, 125, 250, 500, 1000 (can be modified via µVision terminal)	Kbauds

Power Supply		
Typical CAN supply voltage	24	VDC
Min. CAN supply voltage	20	VDC
Max. CAN supply voltage	28	VDC
Typical consumption	1	W

CANopen	
NMT	Slave
Error Control	No
Node ID	Proprietary
No. of PDOs	0 Rx      0 Tx
PDO Modes	No
PDO Linking	No
PDO Mapping	No
No. of SDOs	1 Server    1 Client
Emergency Message	No
CANopen Version	DS-301 V4.0
Framework	No
Device Profile	DSP-403 V1.0
Certified	No

- **NMT [Master/Slave]:**

Describes the role of an appliance within the network. A NMT Master appliance is capable of initializing the network, whilst a NMT Slave appliance is not. NMT = Network Management (a procedure for managing the network).

- **Error Control [Node Guarding / Heartbeat / No]:**

Describes the control mechanism for errors tolerated by the appliance. Node Guarding is a mechanism that, given an appliance which fulfils the role of a NMT Master, monitors the NMT Slave appliances. Heartbeat is a mechanism that cyclically transmits messages via the appliance in question, indicating its presence to other members of the network.

- **Node ID [LMT / HW Switch / Proprietary]:**

Describes the way in which the CAN identifier is assigned to the appliance in question. HW Switch indicates that the identifier is assigned mechanically. LMT indicates that the identifier can be assigned using a message procedure known as LMT (Layer Management). Proprietary indicates a method of assignation different from the first two.

- **No. of PDOs [n RX / m Tx]:**

Indicates how many receiving and transmitting PDOs can be managed by the appliance.

- **PDO Modes:** Indicates which PDO transmission modes can be managed by the appliance.

- **PDO Mapping [Default / Variable]:**

Indicates whether the appliance accepts a change in the data to be transmitted to the inside of PDO messages.

- **No. of SDOs [n Server / m Client]:** Indicates how many Client and Server SDO channels can be managed by the appliance.

- **Emergency Message [Yes / No]:**

Indicates whether the appliance is capable of managing EMCY messages (emergency messages).

- **CANopen Version:** Indicates which version of the CANopen procedure is implemented in the appliance.

- **Device Profile:**

Indicates which CANopen standard is respected by the appliance (DSP 402 = Speed Controllers and Positioners).

- **Certified:** Indicates whether the appliance is certified (CiA Certification).

### 3.5 Use

The µVision terminal provides access to ten separate pages (page 0 - page 9). The page number selected flashes at the top right of the screen. To access any page, press the PAGE key and then the desired page number or the ↑ or ↓ keys.

#### 3.5.1 Description of the various pages displayed

\* **PAGE 0** : Home page

				P	A	R	V	E	X										0
D	I	G	I	V	E	X		µ	V	i	s	i	o	n					

\* **PAGES 1,2,3,4** : These pages contain a visual display of messages sent by variable speed drive positioners.

\* **PAGE 5** : Reserved.

\* **PAGE 6** : Shows the CAN address, CAN baud rate and µVision terminal user name

I	d	:	1	6				B	R	:	1	0	0	0					6
U	s	e	r	n	a	m	e												

Address : CAN network subscriber number (Id)  
 Baud rate: CAN network transmission speed in kbaud (BR: Baud Rate)  
 User name: up to 15 characters

\* **PAGE 7** : Shows the total operating time

			R	U	N	N	I	N	G			T	I	M	E					7
			0	0	0	0	6	:	2	7	:	4	3							

\* **PAGE 8** : Shows the serial number and software version  
 SN : Serial Number  
 SV : Software Version

S	N	:				9	9	1	0	0	0	1								8
S	V	:				A	P	7	5	2	V	0	1							

\* **PAGE 9** : Displays the last 32 fault messages sent over the CAN bus.

Example: Message date (time display)

Error message number→	E	R	R	0	1		0	0	3	6	9	:	1	7					9
	d	0	1		0	5		4	0	0	0	h							

↓

↑

CAN subscriber having generated the message

↑

nature of the error if the subscriber having generated the message is a PARVEX variable speed drive positioner

↑

Error nature following CANopen norm (see §3.6.5 CANopen norm)

The last 32 fault messages are memorized in the EEPROM store. They are displayed on page 9. The last fault message is displayed first.

When a new fault is to be displayed, the read-out switches automatically to page 9 to display the fault. The message flashes and the user must validate by pressing the **ENTER** key.

The time displayed is µVision terminal operating time.

Press **ENTER** to obtain the meaning of the message being visualized in clear text (English).

### 3.5.2 Enter a value - Answer a question

A positioner may request an application-related value (number of parts, cutting length, etc.) or ask a question of the user. The µVision terminal then switches automatically to the page (1-4) with the question:

- Display question from positioner
- Answer with number pad or **YES/NO** keys (use the ← key to correct).
- Press the **ENTER** key to validate.

### 3.5.3 How to use the F1, F2, F3 and F4 keys

The **F1**, **F2**, **F3** and **F4** keys are active providing that the **SHIFT** key was previously selected (red LED activated).

These keys are used to send predetermined messages to the variable speed drive positioners present on the CANopen bus (previously selected variable set to 1 or to 0, see configuration of **F1** to **F4** keys in section §3.6.4).

## 3.6 µVision terminal configuration

---

### 3.6.1 Changing the subscriber number

An identification number is allocated to the µVision terminal when it is first installed in a CAN network. This number must be between 1 and 63 and must not be used by any other device on the network.

To change the identification number:

- Press keys 8 and 2 at the same time. The display reads :

I	d	.		N	o	d	e	:		0	3				
N	E	W		?											

- Enter the new subscriber number (use the ← key to correct).
- Press the **ENTER** key to validate.

Page 6 is then displayed with the new subscriber number which is safeguarded in the EEPROM store.

### 3.6.2 Changing user name

A user name can be specified for the µVision terminal.

- Press keys 8 and 1 at the same time. The display reads :

U	S	E	R	N	A	M	E		?						
U	s	e	r	n	a	m	e								

- The ↑ and ↓ keys scroll through the characters beneath the cursor.
- The ← and +/- keys move the cursor horizontally.
- Press the **ENTER** key to validate

Page 6 is then displayed with the new user name which is safeguarded in the EEPROM.

### 3.6.3 Changing CAN network baud rate

To dialogue with other CAN network subscribers (positioners, etc.), the CAN network transmission speed must be specified. The baud rate is limited by network length.

Attention! The baud rate must be the same for all network users. Default value: 1000 kbauds (do not modify this value without good reason).

To change the CAN baud rate :

- Press keys 8 and 0 at the same time. The display reads:

C	A	N		B	a	u	d	r	a	t	e	?		
1	0	0	0		K	b	a	u	d					

- Select the baud rate with the **↑** and **↓** keys
- Press the **ENTER** key to validate.

Page 6 is then displayed with the new baud rate which is safeguarded in the EEPROM store.

### 3.6.4 Configuration of functions F1, F2, F3 and F4

The selecting of functions **F1**, **F2**, **F3** or **F4** enables a predetermined variable belonging to a variable speed drive positioner present on the CANopen bus to be set to 1 or to 0.

Press the following keys at the same time:

- 9 and 1 are used to access the configuration for function F1
- 9 and 2 are used to access the configuration for function F2
- 9 and 3 are used to access the configuration for function F3
- 9 and 4 are used to access the configuration for function F4

Pressing keys 9 and 1 at the same time (configuration for function F1), displays the following:

The numerical keyboard is used to edit the CAN identifier value of the variable speed drive positioner to which the command will be transmitted (use the **←** key to correct)

I	d	:		0	1							F	1	← function F1
e	x	e	c	_	e	n						=	1	

the **↑** and **↓** keys are used to determine the order (variable name selection)

the **YES** key assigns the value 1 to the selected variable  
the **NO** key assigns the value 0 to the selected variable

The variables which we can choose are:

- none (A support on the touch F1 has no effect)
- ub100
- ub101
- ub102
- ub103
- home\_cmd
- abort\_cmd
- reset\_cmd
- exec\_en
- move\_en
- torque\_cmd

Selection is validated by pressing the **ENTER** key and pressing the **YES** or **NO** key confirms the selection.

### 3.6.5 CANopen norm

CANopen variable speed drive positioner error message codes			Generic error message codes for all CANopen subscribers	
DIGIVEX variable speed drive positioner status_number	CANopen error message code	Description		Description
3	7300h	<i>Resolver failure</i>	00xxh	Error Reset or No Error
4	4110h	<i>Excessive ambient temperature</i>	10xxh	Generic Error
5	4000h	<i>Excessive heatsink temperature</i>	20xxh	Current
6	2000h	<i>High heatsink temperature with reduced current</i>	21xxh	Current, device input side
7	8400h	<i>Excessive motor speed (in rpm)</i>	22xxh	Current inside the device
8	2000h	<i>Excessive supply current</i>	23xxh	Current, device output side
9	2000h	<i>Excessive variable speed drive current</i>	30xxh	Voltage
10	2000h	<i>Excessive dl/dt</i>	31xxh	Mains Voltage
11	2000h	<i>Excessive average current</i>	32xxh	Voltage inside the device
12	2000h	<i>Excessive average current with reduced current</i>	33xxh	Output voltage
13	2000h	<i>Excessive RMS current</i>	40xxh	Temperature
14	2000h	<i>Excessive RMS current with reduced current</i>	41xxh	Ambient Temperature
15	3000h	<i>Bus overvoltage</i>	42xxh	Device Temperature
16	4210h	<i>Excessive motor temperature</i>	50xxh	Device Hardware
17	6320h	<i>Incompatible Axis/Spindle definition</i>	60xxh	Device Software
18	8100h	<i>CAN link fault</i>	61xxh	Internal Software
19	7120h	<i>Motor not connected</i>	62xxh	User Software
20	5500h	<i>User program memory fault</i>	63xxh	Data Set
22	5000h	<i>Personalization board missing</i>	70xxh	Additional Modules
23	6320h	<i>Axis / personalization board incompatible</i>	80xxh	Monitoring
24	6320h	<i>Internal parameter calculation fault</i>	81xxh	Communication
25	8612h	<i>+ Electrical limit reached</i>	90xxh	External Error
26	8612h	<i>- Electrical limit reached</i>	F0xxh	Additional Functions
27	6200h	<i>Program execution fault</i>	FFxxh	Device specific
28	8611h	<i>Tracking error fault</i>		
29	5000h	<i>Option card fault</i>		
30	1000h	Generic error		
31	5300h	<i>C167 CPU Fault</i>		
32	5300h	<i>DSP CPU Fault</i>		
33	8612h	<i>+ Software limit reached</i>		
34	8612h	<i>- Software limit reached</i>		
35	8400h	<i>Excessive application speed (in Units/s)</i>		
37	7300h	<i>Encoder fault</i>		
38	9000h	<i>Emergency stop</i>		
41	8000h	<i>Synchronization message timeout</i>		
42	6320h	<i>Licence missing</i>		