

ACGI



Servo motor



**Product
Manual**

Further descriptions, that relate to this document:

UL: 12-01



Plugs - Product description

UL: 12-02



Cables - Product description

©SSD Drives GmbH.

All rights reserved. No portion of this description may be produced or processed in any form without the consent of the company.

Changes are subject to change without notice.

SSD Drives has registered in part trademark protection and legal protection of designs. The handing over of the descriptions may not be construed as the transfer of any rights.

Made in Germany, 2004

CONTENTS

Page

The most important thing first	5
1 General	6
1.1 Description	6
1.2 Type code	7
1.2.1 Typical example	7
1.3 Possible options (Marking: g)	8
3 Technical data	10
3.1 Torque/Speed Diagrams	12
4 Dimensions	14
4.1 Standard design motor size 01	14
4.1.1 Connections via <u>connectors</u>	14
5 Connector assignment	15
5.1 Power connector	15
5.2 Resolver connector	16
5.3 Cabling instructions	17
5.4 Plug designation	18
5.4.1 Mating plugs for motor- and brake connections	18
5.4.2 Mating plugs for resolver- and thermal connection	18
5.5 Cable designation	18
5.5.1 Motor-cable	18
5.5.2 Resolver-cable	18
6 Technical data of the holding brake	18
7 Shaft loads	19
7.1 Notation of definition	19
7.2 Technical dates of the max. radial F_R (N) and axial F_A (N) shaft load	19
7.3 Use Ball bearing type	19
8 Nominal power dependence of the SSD Drives AC servo motors concerning the installation altitude t.....	20
8.1 Short description	20
9 Certificates	21
10 Modification Record	22

The most important thing first

Thanks for your confidence choosing our product.

These operating instructions present themselves as an overview of the technical data and features.

Please read the operating instructions before operating the product.

If you have any questions, please contact your nearest SSD Drives representative. Improper application of the product in combination with dangerous voltage can lead to injuries.

In addition, damage can also occur to motors or other products.

Therefore please observe our safety precautions strictly.

Safety precautions

We assume that, as an expert, you are familiar with the relevant safety regulations, especially in accordance with VDE 0100, VDE 0113, VDE 0160, EN 50178, the accident prevention regulations of the employers liability insurance company and the DIN regulations and that you are able to use and apply them.

As well, relevant European Directives must be observed.

Depending on the kind of application, additional regulations e.g. UL, DIN are subject to be observed.

If our products are operated in connection with components from other manufacturers, their operating instructions are also subject to be observed strictly.

1 General

1.1 Description

By using high-energy magnetic materials it is possible to design small diameter disk motors. For this reason and due to a carefully optimized technical construction of the rotor, the motors have a low moment of inertia.

The stability of the magnetic material and the design of the magnetic field in the face of demagnetisation allow maximum currents of up to **3- 4 times the rated current**.

The high acceleration capacity of the low-inertia three-phase AC servo drives is the result of this.

Through the excitation of the permanent magnets, no heat losses due to current occur in the rotor.

With the three-phase AC-servomotors AC G heat losses due to current occur only in the stator, which then can be directly drawn off.

These favorable cooling conditions allow high-capacity windings.

Since all the current heat losses are drawn off directly via the surface, the motors are designed at low cost with the enclosure type providing protection in accordance with **IP xx** and they are thus very resistant to liquids and dirt.

The resolver is built into the B-side bearing bracket.

The signals of this integrated measuring system for the actual speed value, the rotor position and the indirect position are taken at the motor over a 12-pin connector.

Synchronous three-phase AC servo drives have a series of advantages over the DC drives:

- no electromechanical parts to wear out, therefore "maintenance-free".
- a low moment of inertia of the rotor due to power density, therefore high acceleration capacity.
- no commutation limit curve, therefore high acceleration moments, also in higher speed ranges.
- no losses in the rotor of the motor, therefore favorable thermic qualities and a high degree of protection due to the closed construction.

Three-phase AC servomotors built in the way described, are specifically more efficient (higher rated torque) than DC servomotors and also have a small moment of inertia. The size necessary for an application will, for this reason, be smaller with three-phase AC servos than with DC servos.

Important !

- The motor series AC G is not attachment- or pin-compatible to our drives AC Mxx or AC R.
- Motor design AC G only in standard.

General

1.2 Type code

Marking	Standard						optional	
	a	b	c	d	e	f	g	h
Type:	AC	XXX	XXXX	-X	/X	-X	XX	+ ...

Marking	Description
a	AC = three-phase
b	motor models: <u>G</u> = motor series <u>G</u> without cases <u>M</u> = motor series (old) <u>Mn</u> = motor series <u>n</u> ew <u>M2n</u> = motor series 2 nd <u>n</u> ew version <u>MHS</u> = motor series <u>H</u> iperface <u>S</u> ingleturn (under preparation) <u>MHM</u> = motor series <u>H</u> iperface <u>M</u> ultiturn <u>R</u> = motor series <u>R</u> <u>R(L)</u> = motor series <u>RL</u> with separate fan
c	<u>xxxx</u> = approx. rated torque in Ncm
d	-4 = 4000 rpm "AC <u>G</u> ; AC <u>Mn</u> ; AC <u>M2n</u> ; AC <u>MHx</u> " 1..6 = *1000 1/min "AC <u>R</u> " (designation does not apply with motor / gearbox systems) -X = further on request
e	/Y..4 = motor size (designation does not apply with motor / gearbox systems)
f	-3 = 325 V DC intermediate circuit rated voltage -6 = 565 V DC intermediate circuit rated voltage
g	identification for <u>options</u> and custom features XX = see chapter 1.3
h	+ ... = with attached gear-box: (for short description for inserted gearbox models see gearbox documentation)

Note:

Up to marking "g" it is only necessary with options or custom features.

No options are possible for the AC G drive.

1.2.1 Typical example

A typical example of an order corresponding to the model key would be:

Type: AC <u>G</u> 0090-4/01-3	Type: AC <u>M2n</u> 0090-4/1-3	Type: AC <u>R</u> 0095-6/1-3
AC = three phase <u>G</u> = motor series 0090 = rated torque in Ncm -4 = 4000 rpm /01 = motor size -3 = 325V DC	AC = three phase <u>M2n</u> = motor series 2 nd new version 0090 = rated torque in Ncm -4 = 4000 rpm /1 = motor size -3 = 325V DC	AC = three phase <u>R</u> = motor series 0068 = rated torque in Ncm -6 = 6000 rpm /1 = motor size -3 = 325V DC

General

1.3 Possible options (Marking: g)

Marking	Options			and Marking	Description	motor types			
	BR	GW	IP 65			A C G	A C M n	A C M 2n	A C R
GW		X			smooth motor shaft	<input type="checkbox"/>	<input checked="" type="checkbox"/>	<input checked="" type="checkbox"/>	<input checked="" type="checkbox"/>
BR	X				holding brake, 24V DC	<input type="checkbox"/>	<input checked="" type="checkbox"/>	<input checked="" type="checkbox"/>	<input checked="" type="checkbox"/>
65			X		degree of protection IP 65	<input type="checkbox"/>	<input checked="" type="checkbox"/>	<input checked="" type="checkbox"/>	<input checked="" type="checkbox"/>
BG	X	X				<input type="checkbox"/>	<input checked="" type="checkbox"/>	<input checked="" type="checkbox"/>	<input checked="" type="checkbox"/>
AI					absolute or incremental encoder preparation of attachment	<input type="checkbox"/>	<input checked="" type="checkbox"/>	<input checked="" type="checkbox"/>	<input checked="" type="checkbox"/>
BI	X			AI		<input type="checkbox"/>	<input checked="" type="checkbox"/>	<input checked="" type="checkbox"/>	<input type="checkbox"/>
PL					electrical connections via PG couplings and cable ends	<input type="checkbox"/>	<input checked="" type="checkbox"/>	<input checked="" type="checkbox"/>	<input checked="" type="checkbox"/>
2P					2 nd featherkey way	<input type="checkbox"/>	<input checked="" type="checkbox"/>	<input checked="" type="checkbox"/>	<input checked="" type="checkbox"/>
6P			X	2P		<input type="checkbox"/>	<input checked="" type="checkbox"/>	<input checked="" type="checkbox"/>	<input checked="" type="checkbox"/>
90					flange receptacle for motor and resolver 90° angled	<input type="checkbox"/>	<input checked="" type="checkbox"/>	<input checked="" type="checkbox"/>	<input type="checkbox"/>
GP		X		PL		<input type="checkbox"/>	<input checked="" type="checkbox"/>	<input checked="" type="checkbox"/>	<input type="checkbox"/>
G6		X	X			<input type="checkbox"/>	<input checked="" type="checkbox"/>	<input checked="" type="checkbox"/>	<input checked="" type="checkbox"/>
MS					mech. custom designs	<input type="checkbox"/>	<input checked="" type="checkbox"/>	<input checked="" type="checkbox"/>	<input checked="" type="checkbox"/>
PU				PL	unpainted motor	<input type="checkbox"/>	<input checked="" type="checkbox"/>	<input checked="" type="checkbox"/>	<input checked="" type="checkbox"/>
PS		X		PU		<input type="checkbox"/>	<input checked="" type="checkbox"/>	<input checked="" type="checkbox"/>	<input type="checkbox"/>
SL					special finish	<input type="checkbox"/>	<input checked="" type="checkbox"/>	<input checked="" type="checkbox"/>	<input checked="" type="checkbox"/>
GK		X			smooth motor shaft shortend	<input type="checkbox"/>	<input checked="" type="checkbox"/>	<input checked="" type="checkbox"/>	<input checked="" type="checkbox"/>
VA	X	X		PL		<input type="checkbox"/>	<input checked="" type="checkbox"/>	<input checked="" type="checkbox"/>	<input type="checkbox"/>
R6			X		rust-proof motor shaft	<input type="checkbox"/>	<input checked="" type="checkbox"/>	<input checked="" type="checkbox"/>	<input type="checkbox"/>
P6			X	PL		<input type="checkbox"/>	<input checked="" type="checkbox"/>	<input checked="" type="checkbox"/>	<input type="checkbox"/>
B6	X		X			<input type="checkbox"/>	<input checked="" type="checkbox"/>	<input checked="" type="checkbox"/>	<input checked="" type="checkbox"/>
F6			X		flange receptacle B-side	<input type="checkbox"/>	<input checked="" type="checkbox"/>	<input checked="" type="checkbox"/>	<input type="checkbox"/>
VI	X	X		AI		<input type="checkbox"/>	<input checked="" type="checkbox"/>	<input checked="" type="checkbox"/>	<input checked="" type="checkbox"/>
GI		X		AI		<input type="checkbox"/>	<input checked="" type="checkbox"/>	<input checked="" type="checkbox"/>	<input checked="" type="checkbox"/>
V6	X	X	X			<input type="checkbox"/>	<input checked="" type="checkbox"/>	<input checked="" type="checkbox"/>	<input checked="" type="checkbox"/>
L6		X	X	PL		<input type="checkbox"/>	<input checked="" type="checkbox"/>	<input checked="" type="checkbox"/>	<input type="checkbox"/>
BL	X		X	PL		<input type="checkbox"/>	<input checked="" type="checkbox"/>	<input checked="" type="checkbox"/>	<input type="checkbox"/>
B4	X				flange B 14	<input type="checkbox"/>	<input checked="" type="checkbox"/>	<input checked="" type="checkbox"/>	<input type="checkbox"/>
VR		X		PL+R6+AI		<input type="checkbox"/>	<input checked="" type="checkbox"/>	<input checked="" type="checkbox"/>	<input type="checkbox"/>
S6			X	PL+R6+2P		<input type="checkbox"/>	<input checked="" type="checkbox"/>	<input checked="" type="checkbox"/>	<input type="checkbox"/>
GZ		X			with Centre hole	<input type="checkbox"/>	<input checked="" type="checkbox"/>	<input checked="" type="checkbox"/>	<input type="checkbox"/>
N6		X	X		with special rotation speed about software (6000)	<input type="checkbox"/>	<input checked="" type="checkbox"/>	<input checked="" type="checkbox"/>	<input type="checkbox"/>
HW		X			with Hollow shaft	<input type="checkbox"/>	<input checked="" type="checkbox"/>	<input checked="" type="checkbox"/>	<input type="checkbox"/>
T6			X		for tropical climate	<input type="checkbox"/>	<input checked="" type="checkbox"/>	<input checked="" type="checkbox"/>	<input type="checkbox"/>
X6				F6 + 2P		<input type="checkbox"/>	<input checked="" type="checkbox"/>	<input checked="" type="checkbox"/>	<input type="checkbox"/>

- standard design
- ◐ optional
- not possible

2 General technical data

		AC G	AC M n	AC M 2 n	AC R
Degree of protection:	IP44 (with separate fan)	<input type="checkbox"/>	<input type="checkbox"/>	<input type="checkbox"/>	<input checked="" type="checkbox"/>
with mounted mating connectors and built-on motor	IP54	<input checked="" type="checkbox"/>	<input checked="" type="checkbox"/>	<input checked="" type="checkbox"/>	<input type="checkbox"/>
	IP65	<input type="checkbox"/>	<input checked="" type="checkbox"/>	<input checked="" type="checkbox"/>	<input checked="" type="checkbox"/>
Magnetic material:	NdFeB	<input checked="" type="checkbox"/>	<input checked="" type="checkbox"/>	<input checked="" type="checkbox"/>	<input type="checkbox"/>
	SE	<input type="checkbox"/>	<input type="checkbox"/>	<input type="checkbox"/>	<input checked="" type="checkbox"/>
Electrical connections:	straight flanged sockets	<input type="checkbox"/>	<input checked="" type="checkbox"/>	<input type="checkbox"/>	<input checked="" type="checkbox"/>
	rotatable 90° angled for motor-, resolver- and thermal connection-flanged sockets	<input checked="" type="checkbox"/>	<input type="checkbox"/>	<input checked="" type="checkbox"/>	<input type="checkbox"/>
	PG couplings with cable ends	<input checked="" type="checkbox"/>	<input checked="" type="checkbox"/>	<input checked="" type="checkbox"/>	<input type="checkbox"/>
Thermal protection of motor:	thermal detector PTC	<input checked="" type="checkbox"/>	<input checked="" type="checkbox"/>	<input checked="" type="checkbox"/>	<input checked="" type="checkbox"/>
Power:	In accordance with DIN VDE 0530 installation site: 1000 ASL T = 100K, Tu 40°C measured with attached cooling surface	<input checked="" type="checkbox"/>	<input checked="" type="checkbox"/>	<input checked="" type="checkbox"/>	<input checked="" type="checkbox"/>
Voltage:	325 V DC	<input checked="" type="checkbox"/>	<input checked="" type="checkbox"/>	<input checked="" type="checkbox"/>	<input checked="" type="checkbox"/>
	565 V DC	<input type="checkbox"/>	<input checked="" type="checkbox"/>	<input checked="" type="checkbox"/>	<input checked="" type="checkbox"/>
	other windings are possible.	<input type="checkbox"/>	<input checked="" type="checkbox"/>	<input checked="" type="checkbox"/>	<input type="checkbox"/>
Cooling:	self-cooling	<input checked="" type="checkbox"/>	<input checked="" type="checkbox"/>	<input checked="" type="checkbox"/>	<input checked="" type="checkbox"/>
	separate cooling	<input type="checkbox"/>	<input type="checkbox"/>	<input type="checkbox"/>	<input checked="" type="checkbox"/>
Operating mode:	Continuous operation S1	<input checked="" type="checkbox"/>	<input checked="" type="checkbox"/>	<input checked="" type="checkbox"/>	<input checked="" type="checkbox"/>
Bearings:	Ball bearings, service life approx. 15.000 h	<input checked="" type="checkbox"/>	<input checked="" type="checkbox"/>	<input checked="" type="checkbox"/>	<input checked="" type="checkbox"/>
Motor shaft: (standard)	with fitting key in accordance with DIN 6885	<input checked="" type="checkbox"/>	<input checked="" type="checkbox"/>	<input checked="" type="checkbox"/>	<input checked="" type="checkbox"/>
Rotational accuracy:	N, in acc. with DIN ISO 2373	<input checked="" type="checkbox"/>	<input checked="" type="checkbox"/>	<input checked="" type="checkbox"/>	<input checked="" type="checkbox"/>
Number of pole pairs:	2	<input type="checkbox"/>	<input type="checkbox"/>	<input type="checkbox"/>	<input checked="" type="checkbox"/>
	3	<input checked="" type="checkbox"/>	<input checked="" type="checkbox"/>	<input checked="" type="checkbox"/>	<input checked="" type="checkbox"/>
Resolver type:	2 pole transmitter resolver	<input checked="" type="checkbox"/>	<input checked="" type="checkbox"/>	<input checked="" type="checkbox"/>	<input checked="" type="checkbox"/>
Insulation class	F (VDE 0530) 155° C, heating 100° K	<input checked="" type="checkbox"/>	<input checked="" type="checkbox"/>	<input checked="" type="checkbox"/>	<input checked="" type="checkbox"/>
Varnish: (standard)	similar RAL 9005 (black)	<input checked="" type="checkbox"/>	<input checked="" type="checkbox"/>	<input checked="" type="checkbox"/>	<input checked="" type="checkbox"/>

- standard design
- ◐ optional
- not possible
- ★ dependent on size

3 Technical data

Type: AC G

AC-Servomotor Type:	size	Nominal- power	Technical data			Static torque	max. Static torque	Static current strom	Moment of inertia included resolver
			Rated torque	Rated current with					
		P_N (KW)	M_N (Nm)	I_{N325} (A)	I_{N560} (A)	M_0 (Nm)	M_{0max} (Nm)	I_0 (A)	J_M (kgcm ²)
AC G0060-4/01-3	01.1	0,25	0,6	1,15	-	0,7	2,1	1,25	0,33
AC G0090-4/01-3	01.2	0,36	0,9	1,75	-	1,1	3,3	2,0	0,51
AC G0170-4/01-3	01.3	0,70	1,7	3,28	-	2,1	6,3	3,8	1,0
AC G0190-4/01-3	01.4	0,78	1,9	3,70	-	2,6	7,8	4,9	1,5

Data at rated speed of 4000 rpm

Technical data

Type: AC G

AC-Servomotor Type:	BG	Mass	Motor- resistance	Motor- inductance	Thermal time constant		Torque constant	e.m.f constant "eff."
					with I_N	with I_{max}		
		m (kg)	$R_{ph/ph}$ (Ω)	$L_{ph/ph}$ (mH)	T_{thN} (min)	T_{thmax} (s)	KT (Nm/A)	KE (V/1000 min ⁻¹)
AC G0060-4/01-3	01.1	1,8	14,4	15,3	11	1,22	0,52	31
AC G0090-4/01-3	01.2	2,0	6,9	8,4	13	1,44	0,52	31
AC G0170-4/01-3	01.3	3,0	2,5	3,6	20	2,22	0,51	31
AC G0190-4/01-3	01.4	3,9	1,5	2,4 *	23	2,55	0,51	31

$$KT: KT_o \approx KT_N$$

Data at rated speed of 4000 rpm

- On account of low inductance the motor AC G0190-4/01-3 is operable only with the Servo Drive 631 / 006.

Technical data

3.1 Torque/Speed Diagrams

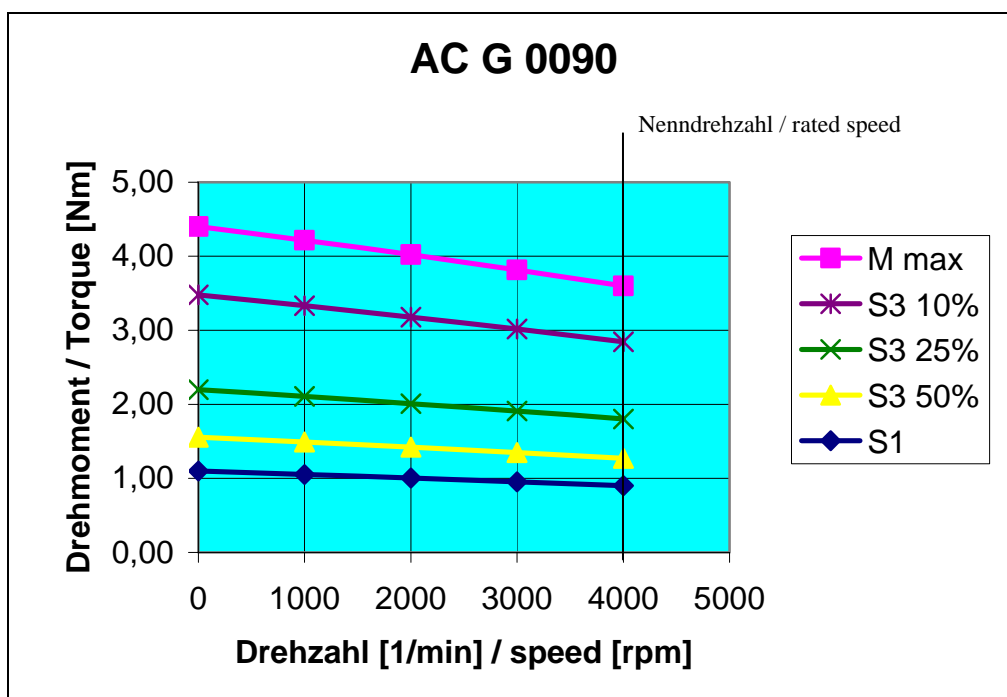
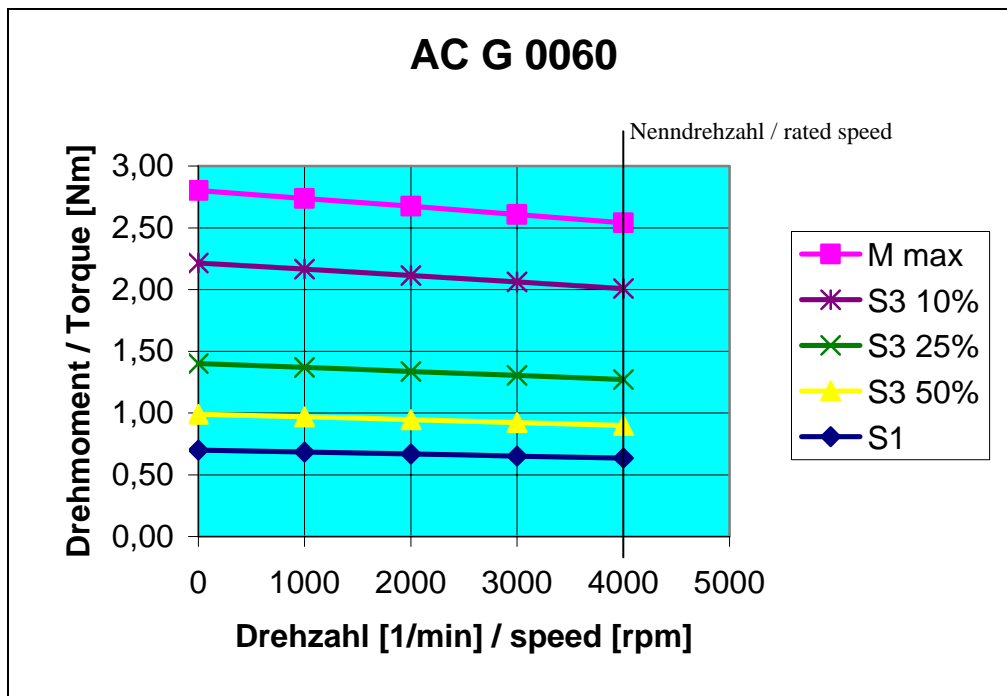

Technical data

Torque/Speed Diagrams

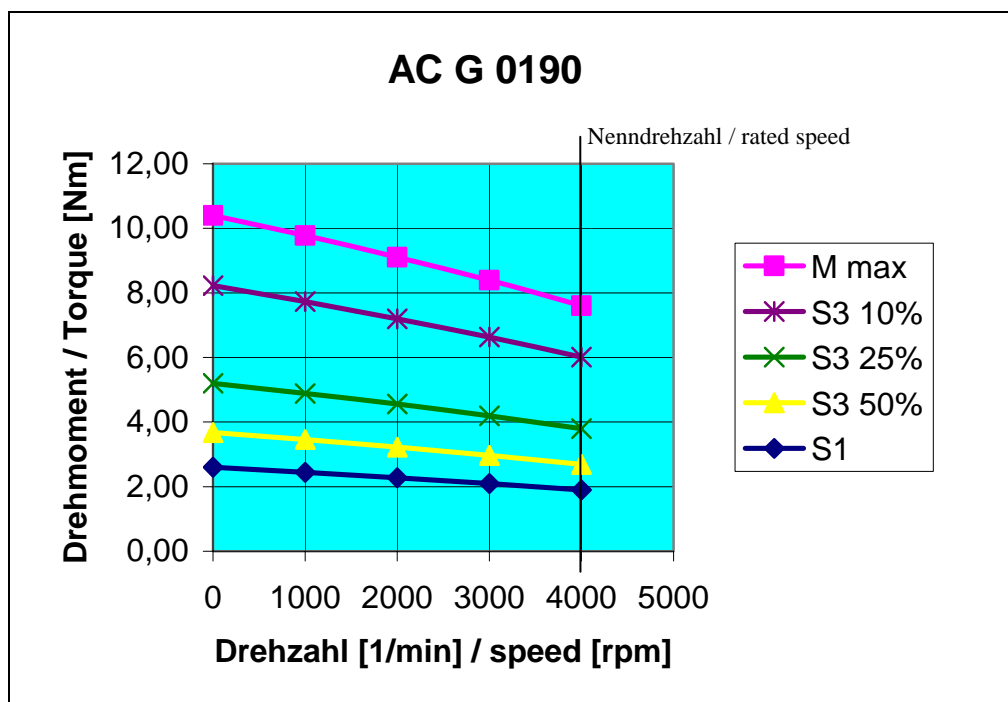
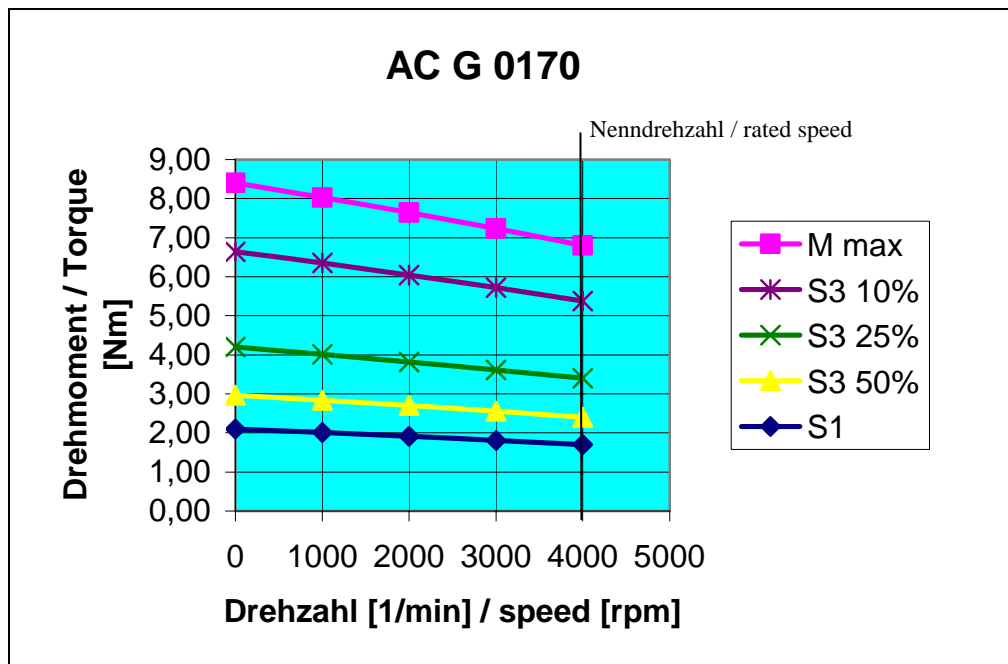

4 Dimensions

4.1 Standard design motor size 01

4.1.1 Connections via connectors

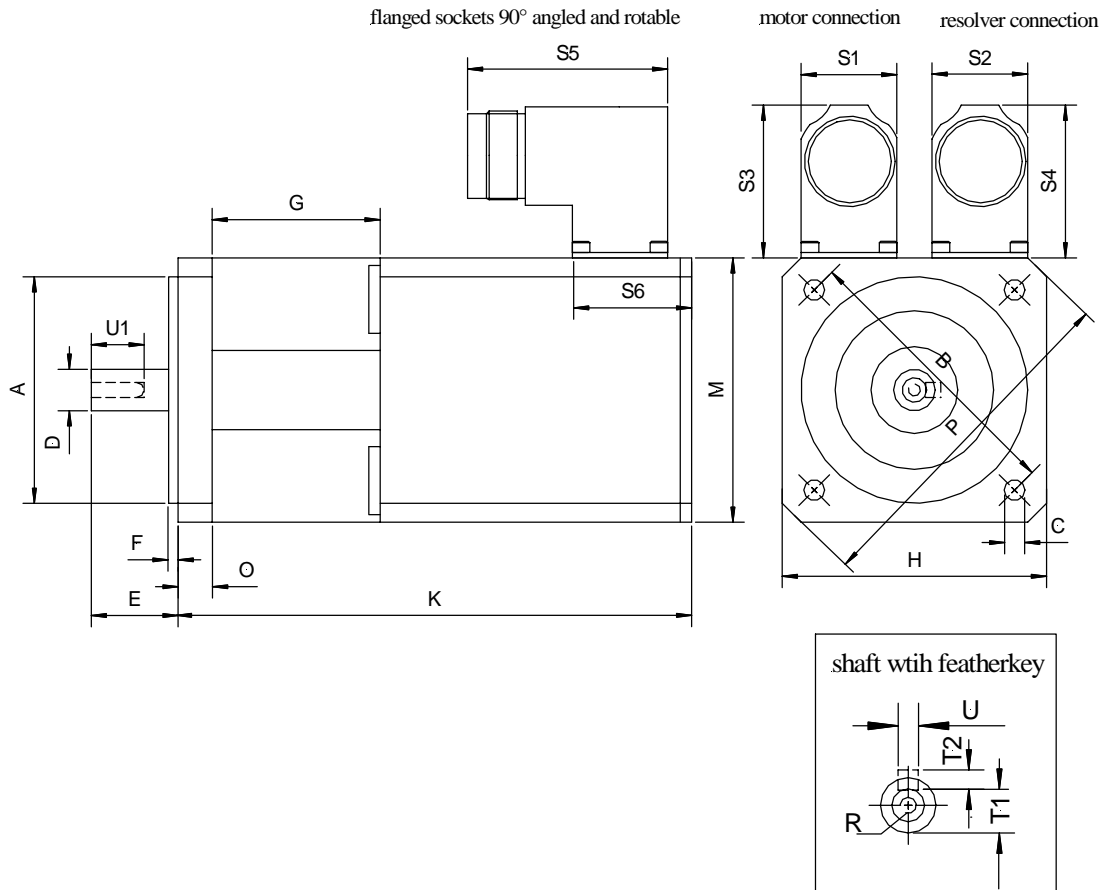

Type	Motor				Resolver			
	S1	S3	S5	S6	S2	S4	S5	S6
AC G0060	25,7	40,0	53,0	31,6	25,7	40,0	53,3	31,6
AC G0090	25,7	40,0	53,0	31,6	25,7	40,0	53,3	31,6
AC G0170	25,7	40,0	53,0	31,6	25,7	40,0	53,3	31,6
AC G0190	25,7	40,0	53,0	31,6	25,7	40,0	53,3	31,6

Type	A (j6)	B	C	D (k6)	E	F	G	H	K	M	O	P	R	T1	T2 (h9)	U (h9)	U1
AC G0060	60	75	5,5	11	23	2,5	44,5	70	136	70	9	92	M3-12	8,5	4	4	14
AC G0090	60	75	5,5	11	23	2,5	44,5	70	146	70	9	92	M3-12	8,5	4	4	14
AC G0170	60	75	5,5	11	23	2,5	44,5	70	176	70	9	92	M3-12	8,5	4	4	14
AC G0190	60	75	5,5	11	23	2,5	44,5	70	205	70	9	92	M3-12	8,5	4	4	14

all specifications in "mm"

5 Connector assignment

5.1 Power connector

Power connector

motor side

SSD Drives - motor size 0...2

Model: AC G, AC M2n; ACM2G; AC M2K
AC MHS / MHM

regulator side

SSD Drives - Servo drives

Model: 631/635 and 637/637+/637f
637+/637f
 in the compact enclosure

view solder / crimp connector - side

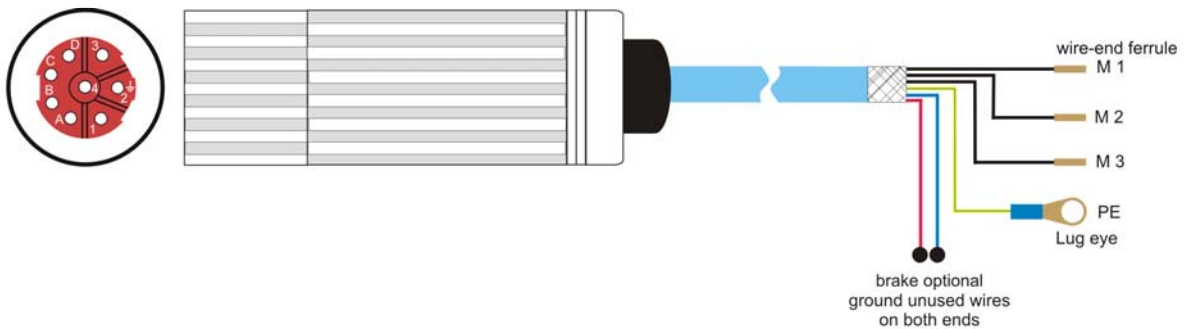

S MB GM2nRn BG 0/3-C+L ST.0100.3001		K MB BG 0/2-B KA.0003.6304		terminal strip	
PIN - Nr.		colour	function	PIN - Nr.	
1		black 1	motor connection	M1	
2	¹⁾	yellow/green	ground connection	PE	
3		black 2	motor connection	M2	
4		black 3	motor connection	M3	
A		red	brake +24V DC ²⁾	Connection	
B		blue	brake 0V DC ²⁾	not on terminal	
C		-	-	-	
D		-	-	-	
case	¹⁾		screen	case	

¹⁾ motor mating plug
 the screen is connected to the groundpin and also extensively to the case.

²⁾ **Attention ! Security and insulation:**
 The brake must be insulated for secure division (PELV). Otherwise, the insulation class of the drive becomes reduced or the effort of an additional galvanic separation is required.

				Maßstab / scale:			
				Typ / model:		KK MB GM2nRn 0/2.K - XX.X / B	
				Bezeichnung / designation:			
				Blue motor cable (compact enclosure) for SSD Drives standard motors and servo drives			
				Zeichnungsnummer / drawing No:		Blatt sheet	
				Z-MK.6400.xxxx		1	
Zust. Änderung Datum Name Ursprung				Dateiname / File name: Z-MK-6400-E.cdr			

5.2 Connector assignment

5.2 Resolver connector

motor side

SSD Drives - motor size 0...4

Type: AC G, AC R, AC Mn,
AC M2n, AC M2K; ACM2G
AC MRW, AC MRL

view solderside

resolver connector

regulator side

SSD Drives - servo drives

Model: 631/635 and 637/637+/637f

view solderside

SIR ST.0200.0001	KIR -B KA.0003.6301		SUB - D 09 S/M ST.1002.2001
PIN - Nr.	colour	function	PIN - Nr.
1	white	sin +	4
2	brown	sin -	8
3	green	cos +	3
4	yellow	cos -	7
5	red	PTC optional	2
6	blue	PTC optional	6
7	pink	carrier -	9
8	gray	carrier +	5
case		screen	case

				Maßstab / scale: Typ / model: KK RT GMR-xx.x/B			
				Bezeichnung / designation: Blue resolver cable for SSD Drives standard motors and servo drives			
05	ACM2K	10.08.04	DL	Bear.	09.05.01	DL	
04	ACMRL	27.11.03	DL	Gep.	10.05.01	EH	
03	ACMRW	02.10.03	DL	Norm			
02	ACM2G	15.08.03	DL	Zeichnungsnummer / drawing No: Z-RK.6300.xxxx			Blatt sheet
01	637f	16.04.03	DL				1
Zust.	Änderung	Datum	Name	Ursprung	Dateiname / File name: Z-R-6300-E.cdr		

Connector assignment

5.3 Cabling instructions

Important rules when operating servo regulators and servomotors:

1. A radio interference suppression level cannot be maintained without an interference suppression filter at the line input. Moreover, line filter increase the immunity of the system to interference.
2. The cable between the power electronics and the motor must be shielded as YCY. A SY shield is not suitable. The shield support for the power cable (motor cable) must be on both ends. We recommend using SSD Drives motor cables K M BG xx – B!
3. Metal parts in the switching cabinet must be connected with each other having large areas of contact and must carry high frequencies very well. Avoid anodized, yellow-passivized and painted surfaces which can have very high resistance values based on the frequency! Make sure that the metals lie close together in the chemical circuit voltage class! Use the good conductivity and the large surface of the galvanized mounting plate as earth potential!
4. Relays, contactors and solenoid valves build into the same circuit must be connected with spark-suppressing combinations or components limiting over voltage, respectively. This applies also if these parts are not mounted in the same cabinet as the servo regulator.
5. The shield for the analog signal lines must be installed on one end and, if possible, in the switching cabinet. Ensure a connection which provides extensive contact and which is low-resistant! The shield for the digital signal lines must be installed on both ends, must have extensive contact and must be low resistance. An additional equalizer is to be laid parallel when there are potential differences. It is necessary to use plugs with metal enclosures with separable connections.
6. Avoid unnecessary extra loops on all connecting cables. All measures regarding filtering and shielding can be short circuited on them with high frequency. Connect unused litz wires in cables on both ends to the equipment ground conductor.
7. Unshielded cables of a circuit, the conductors going out and returning, should be twisted due to symmetrical interferences.
8. Separate physically "live" and "dead" wires even in the planning phase. Give special attention to the motor cables. The area of the common terminal strip-line input and motor output is especially endangered.
9. Relays, contactors and solenoid valves. The cables should be laid in the switching cabinet as close as possible to the ground; wires hanging freely in the air are preferred EMC victims as well as active and passive aerials.
10. When operating with more than one line component in a common network, EMC problems are to be expected. From the start, the installation planner must integrate in his concept high frequency emitted interference as well as the electromagnetic susceptibility of the components to one another and take measures against it.
11. It is absolutely necessary to run cable shields completely up to the connectors. The connection of cable shields to ground must be in the near field of the servo regulator (10 - 50 cm). Sensitive measuring leads should be removed as far as possible from this area; this applies also when they are shielded!
12. It is mandatory to run the motor cables in a separate cable channel and to lay flexible cable shielding also when these are shielded. This channel must be separated by at least 30 - 40 cm from the channel for the signal lines.

Connector assignment

5.4 Plug designation

5.4.1 Mating plugs for motor- and brake connections

Size	Plug designation	Bemerkung
01	S MB G M2nRn 0/3	standard

5.4.2 Mating plugs for resolver- and thermal connection

Size	Plug designation	Comment
01	SIR	standard

5.5 Cable designation

5.5.1 Motor-cable

Size	Cable designation	Comment
01	K MB R BG 0/2 – B K	standard
	MB R BG 0/2 – B - LC	low cost

5.5.2 Resolver-cable

Size	Cable designation	Comment
01	K IR – B	standard
	K IR – B - LC	low cost

6 Technical data of the holding brake

The **AC G** motors are not with holding brake equip !

7 Shaft loads

7.1 Notation of definition

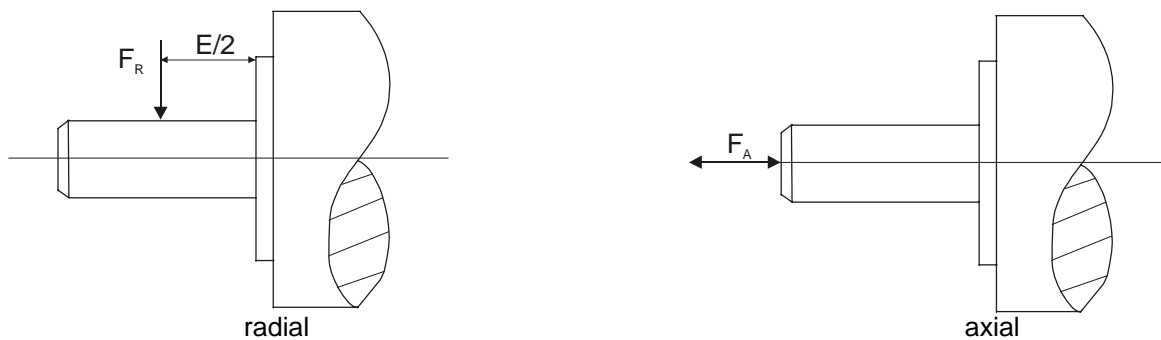

7.2 Technical dates of the max. radial F_R (N) and axial F_A (N) shaft load

Motor-Type	rated speed	maximum radial shaft load	maximum axial shaft load
(-)	N_n (1/min)	F_R (N)	F_A (N)
AC G 0060	4000	150	100
AC G 0090	4000	180	100
AC G 0170	4000	200	100
AC G 0190	4000	220	100

The specifications refers to 20000 hours of operation !

7.3 Use Ball bearing type

Motorsize	Ball bearing type	
	A-side	B-side
01	6002	6000

8 Nominal power dependence of the SSD Drives AC servo motors concerning the installation altitude t

8.1 Short description

When selecting an adequate motor the following is to be considered:

Workload (power), operating mode, starting, braking and by-passing processes, additional moment of inertia, moment course of the operating machine, speed control if necessary, net ratios, coolant temperature, installation height etc.

The nominal power is the power which is mechanically available at the shaft, if the installation site is not situated above 1000 m above NN, the air temperature does not exceed 40° C, and the net ratios are normal.

With differing conditions concerning installation height and air temperature, the permissible power must be corrected corresponding to the following picture.

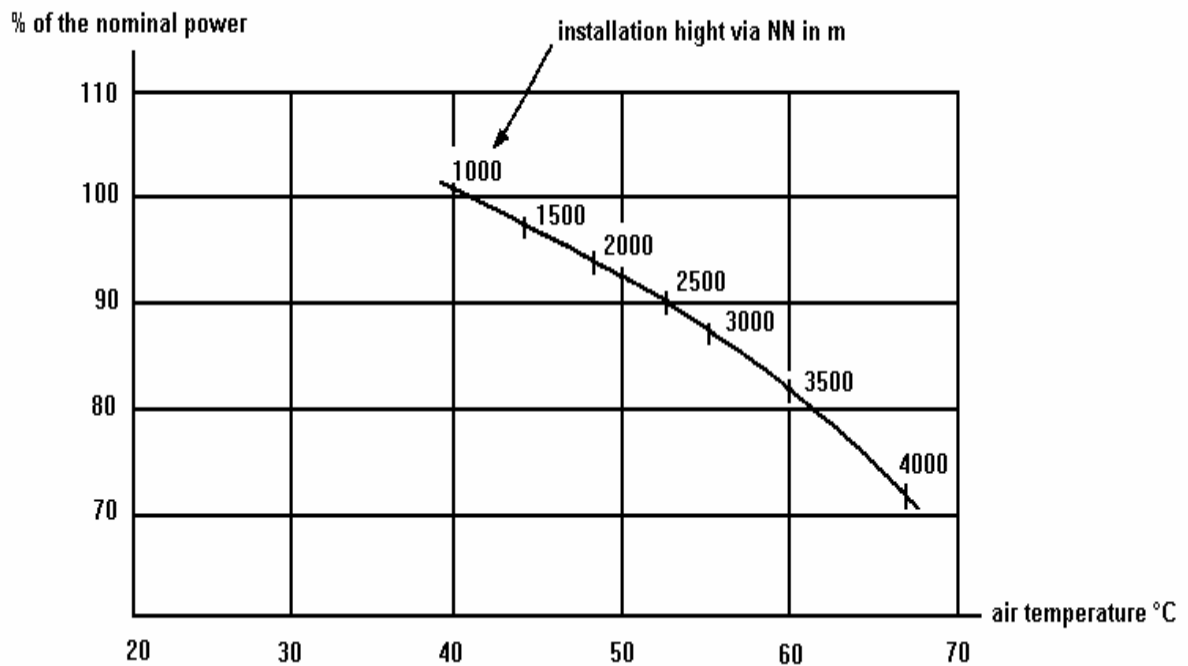

Check the air temperature and the installation height separately. Should there be differing air temperatures and installation heights at the same time, the factors for the permissible power must be multiplied.

9 Certificates



Standard Specifications and Certifications Manufacturer's Declaration

**In accordance with the EC – Machinery Directive 89/392/EEC
Annex II B approximation of the regulation of the member states for machinery.**

The following Products

AC – Servo - motors of series

AC M2n, AC M2K, AC MHx, AC M2G and AC G

in standard design are components to be incorporated into machinery and may not be operated alone. The complete machinery or installation using this equipment may only be put into service when the safety considerations of the Directive 89/3892/EEC are fully adhered to.

The above mentioned products are in accordance with the relevant clauses from the following standards.

Basic directives:

- EN 60034 / VDE 0530
- IEC 34 – 1,5,6,8,9,14 / IEC 72 / IEC 85
- VDE 0100, VDE 0110, VDE 0530-1
- EC – MASCHINERY DIRECTIVE 89/392/EEC
- EC – LOW VOLTAGE DIRECTIVE 73/23/EEC

CE – Label
as standard on the name plate.

Issuer:

SSD Drives GmbH
Im Sand 14
76669 Bad Schönborn

Bad Schönborn, 01.11.2004

Legally binding signature



ppa. Erich Ehlen
Plant Manager

This declaration does not include any assertion of properties. The references for safety and protection (operating instruction) are to observe in every case keep.

10 Modification Record

Version	Modification	Chapter	Date	Name	Comment
V01.03EHST99	new !		08.02.1999	K. Stadler	
V02.15EHST99	re-worked	3, 4.1, 5.1	15.04.1999	K. Stadler	
V03.35EHST99	text modification technical data	1.1 3, 5.1.1, 5.4	03.09.1999	Iris Worm	
V04.19EHST00	Text addition additional techn.data	2 3, 3.1, 5.1, 6.1	11.05.2000	K. Stadler	
V0501	Separation German / English	alle	10.01.2001	N.Dreilich	
V0602	type code torque/speed diagrams drawing dimension K connector assignment power connector resolver connector shaft loads certificates	1.2 3.1 4.1.1 5.1 5.2 6 8	30.08.2002	N.Dreilich	complete new new correction new new new layout new
V0704	SSD Drives			N. Dreilich	Logos

AUSTRALIEN
Eurotherm Pty Ltd
Unit 1
20-22 Foundry Road
Seven Hills
New South Wales 2147
Tel: +61 2 9838 0099
Fax: +61 2 9838 9288

CHINA
Eurotherm Pty Ltd
Apt. 1805, 8 Building Hua Wei Li
Chao Yang District,
Beijing 100021
Tel: +86 10 87785520
Fax: +86 10 87790272

DÄNEMARK
Eurotherm GmbH
Enghavevej 11
DK-7100 Vejle
Tel: +45 70 201311
Fax: +45 70 201312

DEUTSCHLAND
SSD DRIVES GmbH
Von-Humboldt-Straße 10
64646 Heppenheim
Tel: +49 6252 7982-00
Fax: +49 6252 7982-05

ENGLAND
SSD Drives Ltd
New Courtwick Lane
Littlehampton
West Sussex BN17 7RZ
Tel: +44 1903 737000
Fax: +44 1903 737100

FRANKREICH
SSD Drives SAS
15 Avenue de Norvège
Villebon sur Yvette
91953 Courtaboeuf Cedex / Paris
Tel: +33 1 69 185151
Fax: +33 1 69 185159

HONG KONG
Eurotherm Ltd
Unit D
18/F Gee Chang Hong Centre
65 Wong Chuk Hang Road
Aberdeen
Tel: +852 2873 3826
Fax: +852 2870 0148

INDIEN
Eurotherm DEL India Ltd
152, Developed Plots Estate
Perungudi
Chennai 600 096, India
Tel: +91 44 2496 1129
Fax: +91 44 2496 1831

IRLAND
SSD Drives
2004/4 Orchard Ave
Citywest Business Park
Naas Rd, Dublin 24
Tel: +353 1 4691800
Fax: +353 1 4691300

ITALIEN
SSD Drives SpA
Via Gran Sasso 9
20030 Lentate Sul Seveso
Milano
Tel: +39 0362 557308
Fax: +39 0362 557312

JAPAN
PTI Japan Ltd
7F, Yurakucho Building
10-1, Yuakucho 1-Chome
Chiyoda-ku, Tokyo 100-0006
Tel: +81 3 32132111
Fax: +81 3 32131900

KANADA
SSD Drives Inc
880 Laurentian Drive
Burlington
Ontario
Canada, L7N 3V6
Tel: +1 905 333-7787
Fax: +1 905 632-0107

KOREA
Myungshin Drives Co. Ltd.
1308, Daeryung Techno Town
8th Bldg., 481-11 Gasan-Dong,
Geumcheon-Gu,
Seoul 153-803
Tel: +82 2 2163 6677
Fax: +82 2 2163 8982

NIEDERLANDE
Eurotherm BV
Genielaan 4
2404CH
Alphen aan den Rijn
Tel: +31 172 411 752
Fax: +31 172 417 260

POLEN
OBR-USN
ul. Batorego 107
PL 87-100 Torun
Tel: +48 56 62340-21
Fax: +48 56 62344-25

RUMÄNIEN
Servosisteme SRL
Sibiu 17
061535 Bukarest
Tel: +40 723348999
Fax: +40 214131290

SPANIEN
Eurotherm Espana S.A.
Pol. Ind. Alcobendas
C/ La Granja, 74
28108 Madrid
Tel: +34 91 661 60 01
Fax: +34 91 661 90 93

SCHWEDEN
SSD Drives AB
Montörgatan 7
S-30260 Halmstad
Tel: +46 35 177300
Fax: +46 35 108407

SCHWEIZ
Indur Antriebstechnik AG
Margarethenstraße 87
CH 4008 Basel
Tel: +41 61 27929-00
Fax: +41 61 27929-10

U.S.A
SSD Drives Inc.
9225 Forsyth Park Drive
Charlotte
North Carolina 28273-3884
Tel: +1 704 588 3246
Fax: +1 704 588 3249

Weitere Niederlassungen und Vertretungen in:

Ägypten · Argentinien · Bangladesch · Brasilien · Chile · Costa Rica · Ecuador · Griechenland · Indonesien · Island · Israel
Kolumbien · Kuwait · Litauen · Malaysia · Marokko · Mexico · Neuseeland · Nigeria · Peru · Philippinen · Portugal
Österreich · Saudi Arabien · Singapur · Slowenien · Sri Lanka · Süd Afrika · Taiwan · Thailand · Tschechien
Türkei · Ungarn · Vereinigte Arabische Emirate · Vietnam · Zypern

SSD Drives GmbH

Im Sand 14 76669 Bad Schönborn Tel.: +49 7253 9404-0, Fax: +49 7253 9404-99
www.ssddrives.com · ssd@ssddrives.de