

Page



Capacitor Switching -Contactors 2

Typical Circuit Diagram 2



Contactors 3



Auxiliary Contact Blocks 3

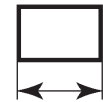

Dimensions 4



Technical Data 5,6,7

Contactor operation 8

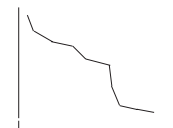

Function 9

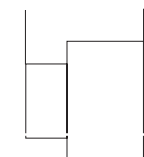

Construction 10

Oscillogram 11

Capacitor Switching Contactors

for use with reactive or non-reactive capacitor banks



Rated Operational Power at 50/60Hz Ambient Temperature						Aux. Contacts Built-in Add.			Type	Coil voltage ¹⁾ 220-240V 50Hz	Pack pcs.	Weight kg/pc.
50°C		60°C		60°C		NO	NC	pcs.		230		
380V	415V	660V	380V	415V	660V							
400V	440V	690V	400V	440V	690V							
kVAr	kVAr	kVAr	kVAr	kVAr	kVAr							
0-12,5	0-13	0-20	0-12,5	0-13	0-20	1	-	1 ²⁾	K3-18K10	...	1	0,34
0-12,5	0-13	0-20	0-12,5	0-13	0-20	-	1	1 ²⁾	K3-18K01	...		
10-20	10,5-22	17-33	10-20	10,5-22	17-33	-	-	3 ³⁾	K3-24K00	...		0,62
10-25	10,5-27	17-41	10-25	10,5-27	17-41				K3-32K00	...		
20-33,3	23-36	36-55	20-33,3	23-36	36-55				K3-50K00	...		1,0
20-50	23-53	36-82	20-50	23-53	36-82				K3-62K00	...		
20-75 ⁴⁾	23-75 ⁴⁾	36-120 ⁴⁾	20-60	23-64	36-100				K3-74K00	...		
33-80	36-82	57-130	33-75	36-77	57-120			6 ⁵⁾	K3-90K00	...		2,3
33-100 ⁶⁾	36-103 ⁶⁾	57-170 ⁶⁾	33-90 ⁶⁾	36-93 ⁶⁾	57-148 ⁶⁾				K3-115K00	...		

Specification: Contactors K3-..K are suitable for switching low-inductive and low loss capacitors in capacitor banks (IEC70 and 831, VDE 0560) without and with reactors.

Capacitor switching contactors are fitted with early make contacts and damping resistors, to reduce the value of make current $< 70 \times I_g$.

Operating Conditions: Capacitor switching contactors are protected against contact welding for a prospective making current of $200 \times I_g$.

Technical Data acc. to IEC 947-4-1, IEC 947-5-1, EN 60947-4-1, EN 60947-5-1, VDE 0660

Type		K3-18K	K3-24K	K3-32K	K3-50K	K3-62K	K3-74K	K3-90K	K3-115K	
Max. frequency of operations z	1/h	120	120	120	120	120	80	80	80	
Contact life	non reactive capacitor banks	$S \times 10^3$	250	150	150	150	150	120	100	75
	reactive capacitor banks	$S \times 10^3$	400	300	300	300	300	200	200	200
Rated operational current I_g	at 50°C	A	0-18	14-28	14-36	30-48	30-72	30-108	50-115	50-144
	at 60°C	A	0-18	14-28	14-36	30-48	30-72	30-87	50-108	50-130
Fuses gL (gG)	from / to	A	35 / 63	50 / 80	63 / 100	80 / 160	125 / 160	160/200	160/200	160/250

Typical Circuit Diagram

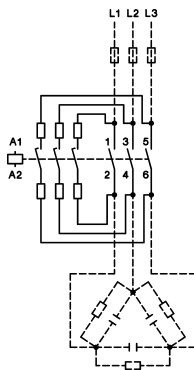

Wiring Diagram for Quick Discharge Resistors

Make sure that the current of the discharge resistors is not higher than the rated current (AC1) of the auxiliary contacts

Mounting instructions:

In the area of capacitor switching contactors, difficulty inflammable and self-extinguishing materials may be used only, because abnormal temperatures within the area of the resistor spirals cannot be excluded.

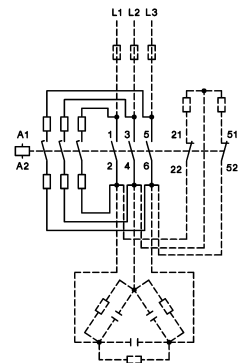

- 1) Coil voltage range and non-standard coil voltages see page 39
- 2) 1 HN.. or HA.. snap-on
- 3) 2HB.. for side mounting and 1 HN.. or HA.. snap-on
- 4) Consider the max. thermal current of the contactor K3-74A: I_{th} 130A
- 5) 2 HB.. on the left or right side and 4 HN.. or HA.. snap-on
- 6) Consider the min. cross-section of conductor at max. load

Contactors

for use with reactive capacitor banks



Rated Operational Power at 50/60Hz Ambient Temperature						Aux. Contacts			Type	Pack	Weight
50°C			60°C			Built-in	Add.	Coil Voltage			
380V kVAr	415V kVAr	660V kVAr	380V kVAr	415V kVAr	660V kVAr	NO	NC	220-240V 50Hz	pcs.	kg/pc.	
5	5,5	8	5	5,5	8	1	-	4 ¹⁾	K3-10A10 230	1	0,23
9	9,5	15	9	9,5	15				K3-14A10 230		
12,5	13	20	12,5	13	20				K3-18A10 230		
13	14	22	13	14	22				K3-22A10 230		
20	22	33	20	22	33	-	-	6 ²⁾	K3-24A00 230		0,48
25	27	41	25	27	41				K3-32A00 230		
27,5	30	48	27,5	30	48				K3-40A00 230		
33,3	36	55	33,3	36	55			6 ²⁾	K3-50A00 230		0,85
50	53	82	50	53	82				K3-62A00 230		
75 ³⁾	75 ³⁾	100	60	64	100				K3-74A00 230		
80	82	130	75	77	120			9 ⁴⁾	K3-90A00 230		2,2
100 ⁵⁾	103 ⁵⁾	170 ⁵⁾	90 ⁵⁾	93 ⁵⁾	148 ⁵⁾				K3-115A00 230		

Auxiliary Contact Blocks



Rated Operational Current				Contacts		Type	Pack	Weight
AC15 230V A	AC1 400V A	AC1 690V A	For Contactors					
			NO	NC	pcs.	kg/pc.		
6	4	25	K3-10.. bis K3-115..		- 1	HA01	10	0,03
3	2	10	K3-24.. to K3-115..		1 1	HB11		0,02
3	2	10	for side mounting		- 2	HB02		
3	2	10	K3-10.. to K3-115..		1 -	HN10		
3	2	10	K3-10.. to K3-115..		- 1	HN01		

- 1) 4 HN.. or HA.. snap-on
- 2) 2HB11 on the left or right side and 4 HN.. or HA.. snap-on
- 3) Consider the max. thermal current: I_{th} 130A
- 4) 2 HB.. on the left or right side and 7 HN.. or HA.. snap-on
- 5) Consider the min. cross-section of conductor at max. load

Capacitor Switching Contactors

Data according to IEC 947-4-1, EN 60947-4-1, VDE 0660

Switching of non-reactive and reactiv 3-phase capacitor banks			Type	K3-18K	K3-24K	K3-32K	K3-50K	K3-62K	K3-74K	K3-90K	K3-115K
Ambient temperature $\leq 50^{\circ}\text{C}$											
Rated operational current I_e	690V	A	0-18	14-28	14-36	30-48	30-72	30-108 ¹⁾	50-115	50-144 ²⁾	
Rated operational power	220-240V	kVAr	0-7	5-11	5-14	12-20	12-28	12-33	20-45	20-55 ²⁾	
	380-400V	kVAr	0-12,5	10-20	10-25	20-33,3	20-50	20-75 ¹⁾	33-80	33-100 ²⁾	
	415-440V	kVAr	0-13	10,5-22	10,5-27	23-36	23-53	23-75 ¹⁾	36-82	36-103 ²⁾	
	500V	kVAr	0-15	12-25	12-30	26-40	26-60	26-75	43-100	43-120 ²⁾	
	525V	kVAr	0-15	12-25	12-32	26-43	26-64	26-80	45-105	45-125 ²⁾	
	660-690V	kVAr	0-20	17-33	17-41	36-55	36-82	36-120	57-130	57-170 ²⁾	
	1000V	kVAr	-	-	-	-	-	-	85-160	85-200 ²⁾	
Ambient temperature $\leq 60^{\circ}\text{C}$											
Rated operational current I_e	690V	A	0-18	14-28	14-36	30-48	30-72	30-87	50-108	50-130 ²⁾	
Rated operational power	220-240V	kVAr	0-7	5-11	5-14	12-20	12-28	12-30	20-40	20-50 ²⁾	
	380-400V	kVAr	0-12,5	10-20	10-25	20-33,3	20-50	20-60	33-75	33-90 ²⁾	
	415-440V	kVAr	0-13	10,5-22	10,5-27	23-36	23-53	23-64	36-77	36-93 ²⁾	
	500V	kVAr	0-15	12-25	12-30	26-40	26-60	26-70	43-90	43-110 ²⁾	
	525V	kVAr	0-15	12-25	12-32	26-43	26-64	26-75	45-95	45-115 ²⁾	
	660-690V	kVAr	0-20	17-33	17-41	36-55	36-82	36-100	57-120	57-148 ²⁾	
	1000V	kVAr	-	-	-	-	-	-	85-150	85-180 ²⁾	

Switching of reactiv 3-phase capacitor banks			Type	K3-18A	K3-24A	K3-32A	K3-50A	K3-62A	K3-74A	K3-90A	K3-115A
Ambient temperature $\leq 50^{\circ}\text{C}$											
Rated operational current I_e	690V	A	18	28	36	48	72	108 ¹⁾	115	144 ²⁾	
Rated operational power	220-240V	kVAr	7	11	14	20	28	33	45	55 ²⁾	
	380-400V	kVAr	12,5	20	25	33,3	50	75 ¹⁾	80	100 ²⁾	
	415-440V	kVAr	13	22	27	36	53	75 ¹⁾	82	103 ²⁾	
	500V	kVAr	15	25	30	40	60	75	100	120 ²⁾	
	525V	kVAr	15	25	32	43	64	80	105	125 ²⁾	
	660-690V	kVAr	20	33	41	55	82	120	130	170 ²⁾	
	1000V	kVAr	-	-	-	-	-	-	160	200 ²⁾	
Ambient temperature $\leq 60^{\circ}\text{C}$											
Rated operational current I_e	690V	A	18	28	36	48	72	87	108	130 ²⁾	
Rated operational power	220-240V	kVAr	7	11	14	20	28	30	40	50 ²⁾	
	380-400V	kVAr	12,5	20	25	33,3	50	60	75	90 ²⁾	
	415-440V	kVAr	13	22	27	36	53	64	77	93 ²⁾	
	500V	kVAr	15	25	30	40	60	70	90	110 ²⁾	
	525V	kVAr	15	25	32	43	64	75	95	115 ²⁾	
	660-690V	kVAr	20	33	41	55	82	100	120	148 ²⁾	
	1000V	kVAr	-	-	-	-	-	-	150	180 ²⁾	

1) Consider the max. thermal current: I_{th} 130A

2) Consider the min. cross-section of conductor at max. load

Capacitor Switching Contactors for North America

Data according to UL508

Main Contacts (cULus)	Type	K3-18K	K3-24K	K3-32K	K3-50K	K3-62K	K3-74K	K3-90K	K3-115K
Rated operational power of 3-phase capacitor banks at 60Hz (3ph)	110-120V kVAr	0-3,5	3-5,5	3-7	6,5-10	6,5-15	6,5-18 ¹⁾	10-24	10-28 ²⁾
	200V kVAr	0-6	4,5-10	4,5-12,5	10-16,7	10-25	10-32 ¹⁾	17-40	17-46 ²⁾
	220-240V kVAr	0-7	5,5-11	5,5-15	12,5-20	12,5-30	12,5-36 ¹⁾	20-47	20-56 ²⁾
	440-480V kVAr	0-15	11,5-25	11,5-30	25-40	25-60	25-72 ¹⁾	40-95	40-114 ²⁾
	550-600V kVAr	0-18	14,5-30	14,5-35	31-50	31-75	31-90 ¹⁾	50-120	50-143 ²⁾
Fuse Class RK5 / Short-circuit current	A/kA	50/5	90/5	125/5	200/5	250/5	300/5	300/10	300/10
Fuse Class T / Short-circuit current	A/kA	70/100	110/100	150/100	175/100	175/100	175/100	300/100 ³⁾	300/100 ³⁾
Rated voltage	V	600	600	600	600	600	600	600	600
Auxiliary Contacts (cULus)		A600	-	-	-	-	-	-	-





1) Consider the max. thermal current of the contactor K3-74A: I_{th} 130A

2) Consider the min. cross-section of conductor at max. load

3) Class T and Class RK1

Contactors

Data according to IEC 947-4-1, EN 60947-4-1, VDE 0660

Main Contacts	Type	K3-10	K3-14	K3-18	K3-22	K3-24	K3-32	K3-40	K3-50	K3-62	K3-74	K3-90	K3-115
Rated insulation voltage U_i ¹⁾	V AC	690	690	690	690	690	690	690	690	690	690	1000	1000
Rated operational current I_e (= I_{th}) at 40°C, open 690V	A	25	25	32	32	50	65	80	110	120	130	160	200
Maximum ambient temperature													
Operation	open °C												
	enclosed °C												
Storage	°C												
Short circuit protection													
Coordination-type "1" acc. to IEC 947-4-1													
Contact welding without hazard of persons													
fuse size	from gL (gG) A	35	35	35	35	50	63	63	80	125	160	160	160
	to gL (gG) A	63	63	63	63	80	100	100	160	160	200	200	250
Cable cross-sections													
for contactors without thermal overload relay													
1 cable per clamp													
main connector	solid or stranded mm ²		0,75 - 6				1,5 - 25			4 - 50			
	flexible mm ²		1 - 4				2,5 - 16			10 - 35			
	flexible with multicore cable end mm ²		0,75 - 4				1,5 - 16			6 - 35			
2 cables per clamp													
	solid or stranded mm ²		6+(1-6) / 4+(0,75-4)				16+(2,5-6) / 10+(4-10)			50+4 / 35+6 / 25+(6-16)			top below 0,5-95+10-120
	flexible mm ²		2,5+(0,75-2,5) / 1,5+(0,75-1,5)				6+(4-6) / 4+(2,5-4)			16+(6-16) / 10+(6-16)			0,5-70+10-95
			6+(1,5-6) / 4+(1-4)				16+(2,5-6) / 10+(4-10)			50+(4-10) / 35+(4-16)			
			2,5+(0,75-2,5) / 1,5+(0,75-1,5)				6+(4-6) / 4+(2,5-4)			25+(4-25) / 16+(4-16)			
Cables per clamp			2				2			2			1+1
for main connector	solid AWG		18 - 10				16 - 10			12 - 10			
	flexible AWG		18 - 10				14 - 4			10 - 0			
Cables per clamp			2				1			1			
	solid AWG		10+(16-10) / 12+(18-12)				10+(16-10) / 12+(18-12)			10+(12-10) / 12+12			top below 18-10 -
	flexible AWG		14+(18-14) / 16+(18-16)				14+(18-14) / 16+(18-16)			1+(12-10) / 2+(8-12)			18-3/0 8-4/0
			10+(14-10) / 12+(18-12)				4+(18-12) / 6+(18-8)			3+(12-8) / 4+(10-6)			
			14+(18-14) / 16+(18-16)				8+(18-8) / 10+(18-12)						
Cables per clamp			2				2			2			1+1
Mechanical life													
AC operated	S x 10 ⁶		10				10			10			5
DC operated	S x 10 ⁶		10				10			10			5
Short time current	10s-current A	96	120	144	176	184	240	296	360	504	592	680	880
Power loss													
per pole	at I_e /AC3 400V W	0,21	0,35	0,5	0,75	0,7	1,3	2	2,2	3,9	5,5	4,3	6,0

1) With reduced control voltage range 0,9 up to 1,0 x U_s and with reduced rated current I_e /AC1 according to I_e /AC3

2) Maximum cable cross-section with prepared conductor

Data according to IEC 947-4-1, EN 60947-4-1, VDE 0660

Auxiliary Contacts	Type	K3-10	K3-14	K3-18	K3-22	K3-24	K3-32	K3-40	K3-50	K3-62	K3-74	K3-90	K3-115
Rated insulation voltage U_i ¹⁾	V~	690			-			-			-		
Thermal rated current I_{th} to 690V													
Ambient temperature	40°C A	16			-			-			-		
	60°C A	12			-			-			-		
Utilization category AC15													
Rated operational current I_e	220-240V A	12			-			-			-		
	380-415V A	4			-			-			-		
	440V A	4			-			-			-		
	500V A	3			-			-			-		
	660-690V A	1			-			-			-		
Utilization category DC13													
Rated operational current I_e	60V A	8			-			-			-		
	110V A	1			-			-			-		
	220V A	0,1			-			-			-		
Short circuit protection													
short-circuit current 1kA, contact welding not accepted max. fuse size	gL (gG) A	25			-			-			-		
Control Circuit													
Power consumption of coils													
AC operated	inrush VA	33-45			90-115			140-165			190-280		
	sealed VA	7-10			9-13			13-18			2,5-5		
	W	2,6-3			2,7-4			5,4-7			2,5-5		
DC operated	inrush W	75			140			200			190-280		
	sealed W	2			2			6			2,5-5		
Operation range of coils													
in multiples of control voltage U_s													
	AC operated	0,85-1,1			0,85-1,1			0,85-1,1			0,85-1,1		
	DC operated	0,8-1,1			0,8-1,1			0,8-1,1			0,8-1,1		
Switching time													
at control voltage $U_s \pm 10\%$ ^{2) 3)}													
AC operated	make time ms	8-16			10-25			12-28			20-35		
	release time ms	5-13			8-15			8-15			35-50		
	arc duration ms	10-15			10-15			10-15			10-15		
DC operated	make time ms	8-12			10-20			12-23			20-35		
	release time ms	8-13			10-15			10-18			35-50		
	arc duration ms	10-15			10-15			10-15			10-15		
Cable cross-section													
Auxiliary connector	solid mm ²	0,75-6			-			-			-		
	flexible mm ²	1-4			-			-			-		
	flexible with multicore cable end mm ²	0,75-4			-			-			-		
Magnet coil	solid mm ²	0,75-2,5			0,75-2,5			0,75-2,5			0,75-2,5		
	flexible mm ²	0,5-2,5			0,5-2,5			0,5-2,5			0,5-2,5		
	flexible with multicore cable end mm ²	0,5-1,5			0,5-1,5			0,5-1,5			0,5-1,5		
Clamps per pole		2			2			2			2		
Auxiliary connector	solid AWG	18 - 10-			-			-			-		
	flexible AWG	18 - 10			-			-			-		
Magnet coil	solid AWG	14 - 12			14 - 12			14 - 12			14 - 12		
	flexible AWG	18 - 12			18 - 12			18 - 12			18 - 12		
Clamps per pole		2			2			2			2		

1) Suitable for: earthed-neutral systems, overvoltage category I to IV, pollution degree 3 (standard-industry): $U_{imp} = 8kV$. Data for other conditions on request

2) Total breaking time = release time + arc duration

3) Values for delay of the release time of the make contact and the make time of the break contact will be increased, if magnet coils are protected against voltage peaks (varistor, RC-unit, diode-unit)

Contactors

Dimensions

Capacitor switching contactors, AC operated

K3-18K..

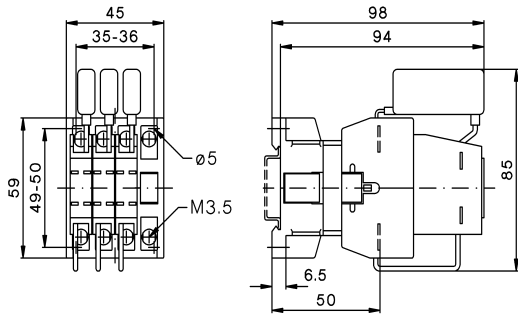

Contactors AC-operated

**K3-10A10
K3-14A10
K3-18A10
K3-22A10**

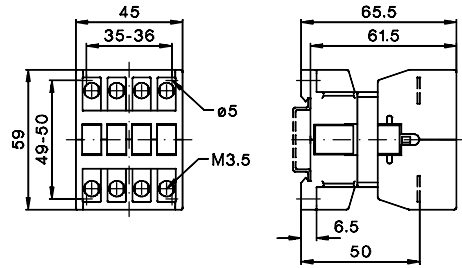

**K3-24K00
K3-32K00**

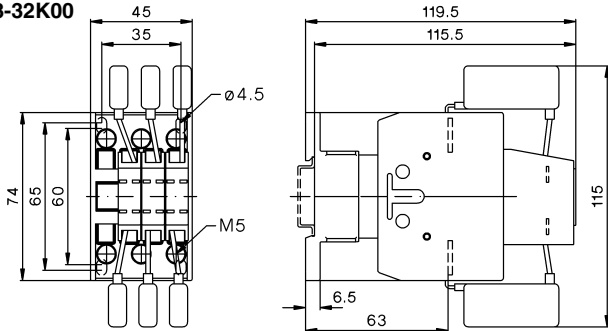

**K3-24A00
K3-32A00
K3-40A00**

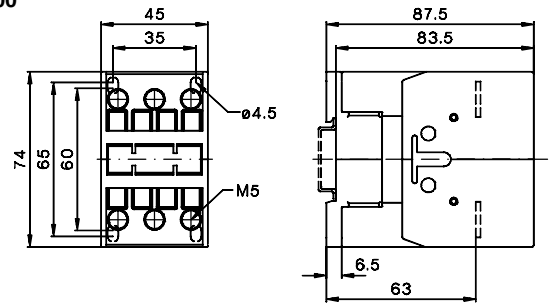

**K3-50K00
K3-62K00
K3-74K00**

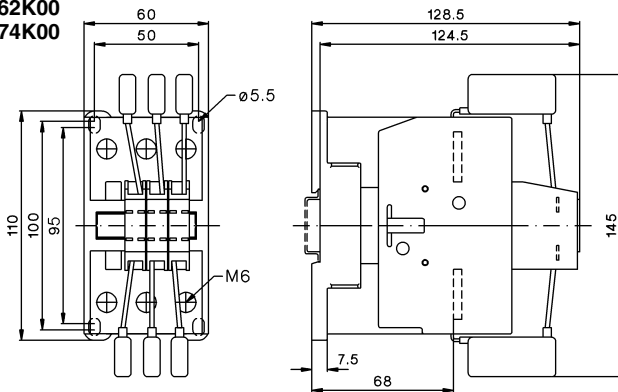

**K3-50A00
K3-62A00
K3-74A00**

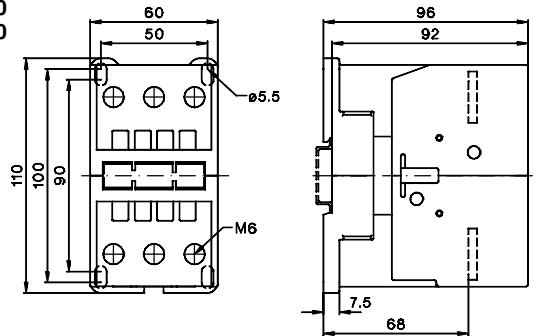

**K3-90K00
K3-115K00**

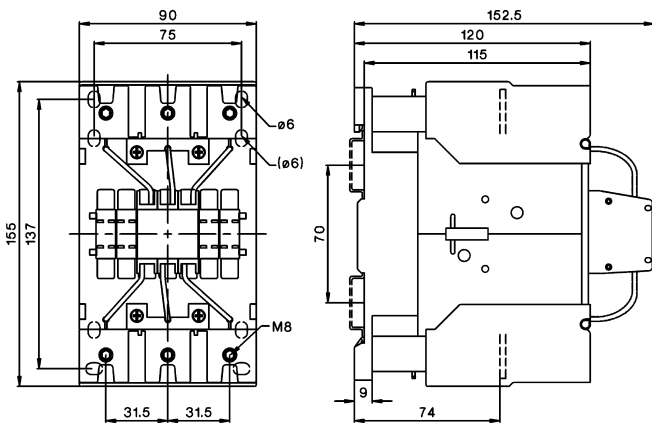

**K3-90A00
K3-115A00**

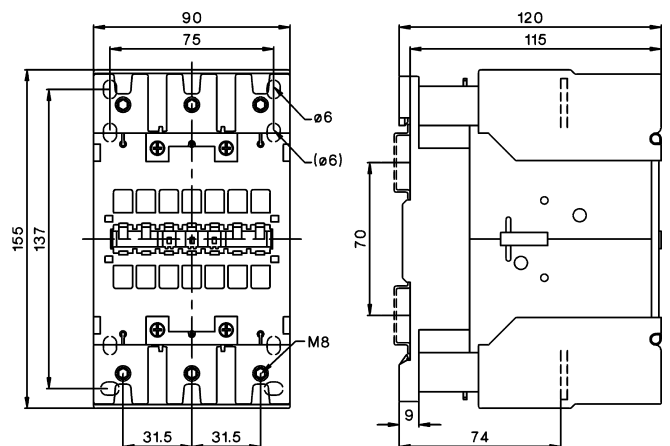

Contactor operation at direct switching of capacitors

Theoretic view of function

Make

In case of the pre-contacts during make, the current peaks are attenuate by resistor wires. These current peaks would weld the main-contacts of contactor and they are also not good for the capacitors.

The total resistance of the resistor wires is mostly ohmic, the inductive one can be ignored. The looking like a coil is only a case of construction.

The single controlled pre-contacts are increasing the safety of operating, in opposite of contamination during operation.

Operation:

During operation the resistor wires are not getting warmer, because they are not in the circuit.

Break:

Important: these contactors can be used for both installations, because the pre-contacts have no function during break, thus means that the peaks of the break-over voltage (power) of the chokes can't make any damage.

Description

Function diagram

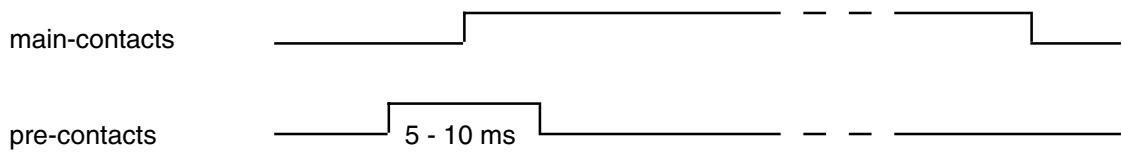

Practical function - oscillogram

make with pre-contacts (B&J\Oszi11)

K3-18K 12.5kVAr (18A / 400V)

vertical: **250A** / div horizontal: 1ms / div

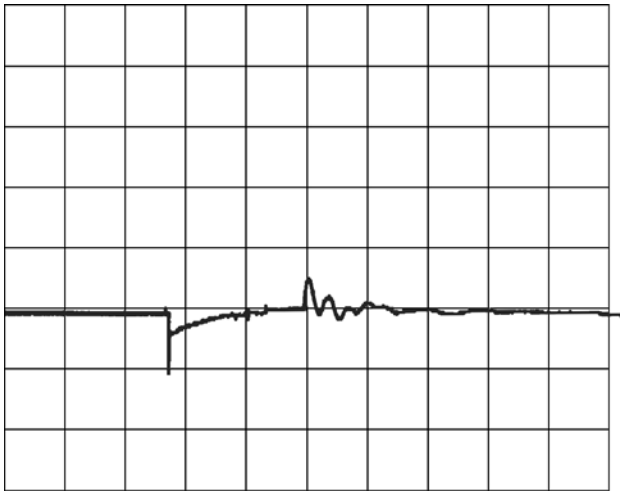

Description:

The difference of the diagrams is the current scale only.

First current peak due to make of pre-contacts.

Second current peak due to building-up the main-circuit with notable lower amplitude as the first and not so steep, that means lower frequency.

make with pre-contacts (B&J\Oszi10)

K3-18K 12.5kVAr (18A / 400V)

vertical: **100A** / div horizontal: 1ms / div

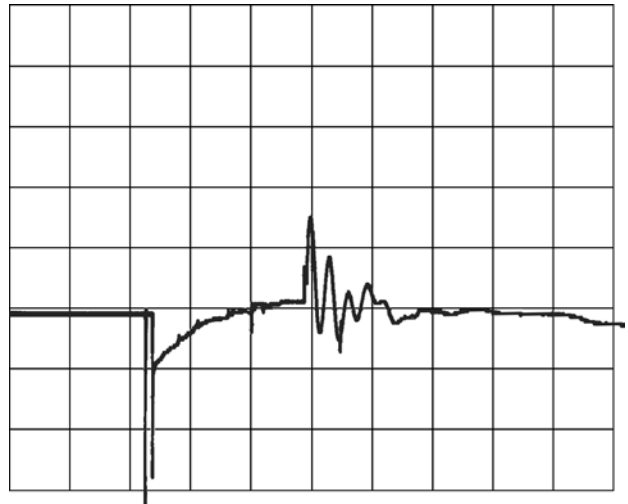

Description

make **with** pre-contacts (B&J\Oszi13)

K3-18K 12.5kVAr (18A / 400V)

vertical: 250A / div horizontal: 0.5ms / div

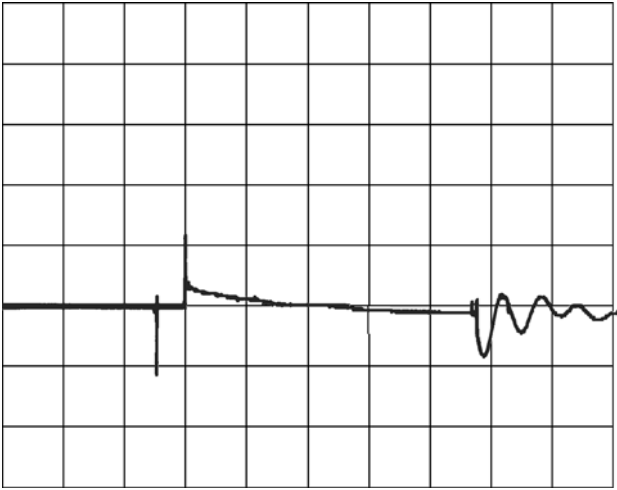

make **without** pre-contacts (B&J\Oszi12)

K3-18A 12.5kVAr (18A / 400V)

vertical: 250A / div horizontal: 0.5ms / div

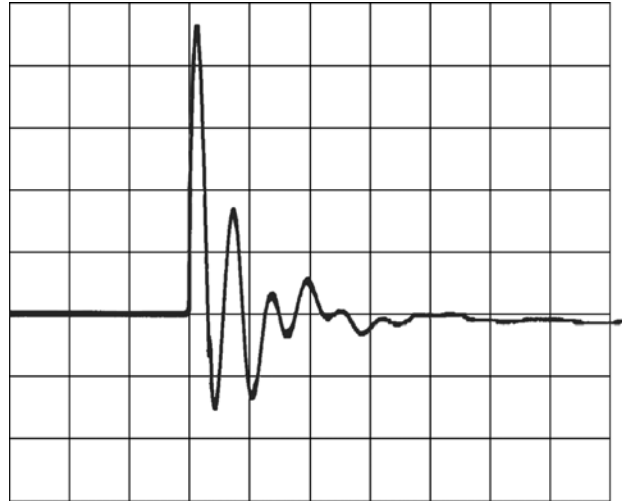

The difference of the left picture to the others before is the time scale.
The peak before the first current peak can be seen as a measuring failure.

The right picture shows a make current peak without pre-contacts with about 1200A with high power in opposite to 280A with low power (power = integrated area).

Of course, the contactors endure a few switches without pre-contacts.

Switching of capacitor banks at different conditions

make **without** pre-contacts (B&J\Oszi16)
without chokes

K3-62A 50kVAr (72A / 690V)

vertical: **2000A** / div horizontal: 0.625ms / div

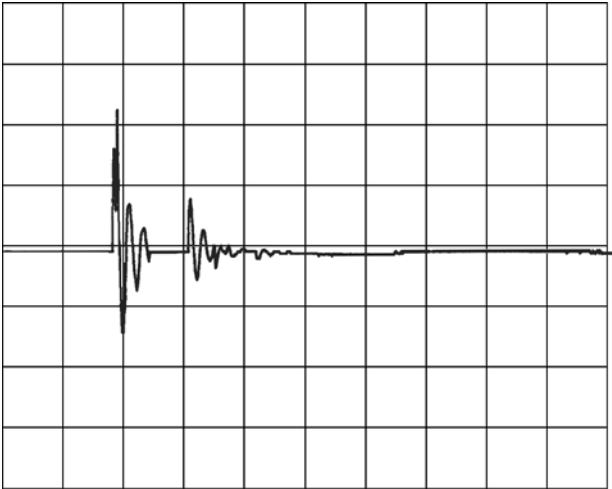

make **without** pre-contacts (B&J\Oszi15)
with chokes

K3-62A 50kVAr (72A / 690V)

vertical: **200A** / div horizontal: 10ms / div

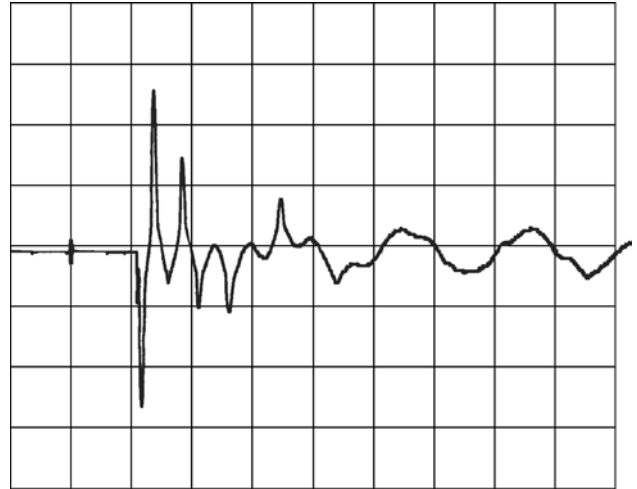

make **with** pre-contacts (B&J\Oszi14)
with chokes

K3-62K 50kVAr (72A / 690V)

vertical: **200A** / div horizontal: 10ms / div

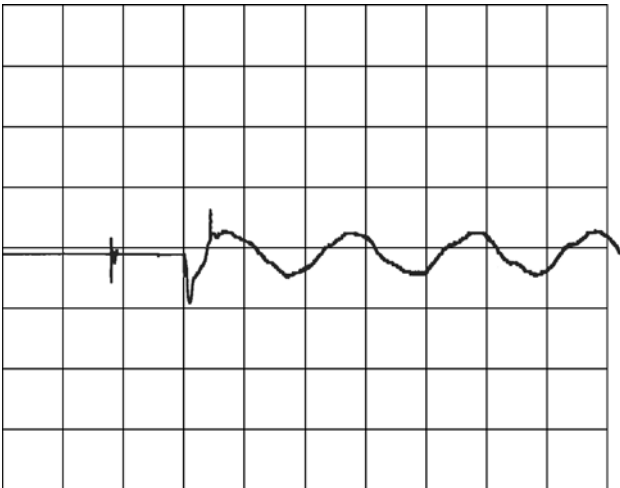

The make current peak without pre-contacts and without chokes is higher than 4000A.

This peak can be reduced by the influence of chokes to approx. 500A.

In the last case we see the influence of chokes and pre-contacts of the "capacitor contactor". The peak is reduced to approx. 200A.

Also the sinus-wave is very clear by the influence of chokes because you have reduced harmonic frequencies.

Notice: